

Alma Mater Studiorum Università di Bologna
Archivio istituzionale della ricerca

A Petri-net approach for firefighting force allocation analysis of fire emergency response with backups

This is the final peer-reviewed author's accepted manuscript (postprint) of the following publication:

Published Version:

Zhou, J.F., Reniers, G., Cozzani, V. (2023). A Petri-net approach for firefighting force allocation analysis of fire emergency response with backups. RELIABILITY ENGINEERING & SYSTEM SAFETY, 229, 1-12 [10.1016/j.ress.2022.108847].

Availability:

This version is available at: <https://hdl.handle.net/11585/899230> since: 2022-11-03

Published:

DOI: <http://doi.org/10.1016/j.ress.2022.108847>

Terms of use:

Some rights reserved. The terms and conditions for the reuse of this version of the manuscript are specified in the publishing policy. For all terms of use and more information see the publisher's website.

This item was downloaded from IRIS Università di Bologna (<https://cris.unibo.it/>).
When citing, please refer to the published version.

(Article begins on next page)

A Petri-net approach for firefighting force allocation analysis of fire emergency response with backups

Jianfeng Zhou^{a, *}, Genserik Reniers^{b, c, d}, Valerio Cozzani^e

- a. School of Electromechanical Engineering, Guangdong University of Technology, Guangzhou 510006, China
- b. Faculty of Technology, Policy and Management, Safety and Security Science Group (S3G), TU Delft, 2628 BX Delft, The Netherlands
- c. Faculty of Applied Economics, Antwerp Research Group on Safety and Security (ARGoSS), Universiteit Antwerpen, 2000 Antwerp, Belgium
- d. CEDON, KULeuven, 1000 Brussels, Belgium
- e. Laboratory of Industrial Safety and Environmental Sustainability - DICAM, University of Bologna, via Terracini n.28, 40131 Bologna, Italy

Abstract: Fire is one of the main accident scenarios occurring in chemical and process plants, and it can lead to domino effects due to thermal radiation. Emergency response is necessary to prevent fire escalation, in addition to safety barriers. In major industrial fire accidents, backup is usually required in emergency response, due to the lack of emergency response capacity of a single emergency response department. A method addressing the optimal allocation of emergency response forces, specifically considering the front-line departments, is developed in the present study. The emergency response of the front-line departments can reduce the thermal radiation received by the equipment adjacent to the primary fire and thus prolong the time to failure of the equipment, such that the backups have more time to get to the fire scene. The allocation analysis of emergency response teams is carried out considering the dynamic t_{ff} of an adjacent equipment item resulting from the change in time of the thermal radiation received. A timed colored hybrid Petri-net (TCHPN) approach is proposed to model the emergency response process. The probability of preventing fire escalation is obtained from the TCHPN model and the optimal allocation of firefighting forces is determined. A case study illustrates the proposed approach, two scenarios are compared and results show that if a request for backup can be issued immediately according to the fire state, fewer emergency forces can be deployed on the front line department, such as

*Corresponding author. E-mail address: jf.zhou@gdut.edu.cn Tel: 8620-39322212

the reduction from 6 emergency response teams to 3 teams to maintain the success probability of 0.91. The influence of other factors such as the position of fire departments and the layout of tanks on the allocation of emergency forces is also discussed.

Keywords: fire escalation; domino effect; emergency response; allocation analysis; Petri-net

1. INTRODUCTION

In the petrochemical industry, large amounts of flammable substances are often handled or stored. Fire is one of the main hazards in these installations. Escalation of fires in chemical and process plants often took place in past accidents, causing domino effects resulting in huge damage of assets and environment, and in multiple fatalities and injuries among the workers and the nearby population (Reniers and Cozzani, 2013; Cozzani and Reniers, 2021).

Fire is among the main categories of primary accidents that may cause domino effect and escalation. Darbra et al. (2010) concluded that fire was the primary event in 52% of the cases after they analyzed 225 domino effect accidents occurred in process/storage plants and in the transportation of hazardous materials. The research also pointed out that storage areas are the most probable locations where a domino effect may be started (35%), followed by process plants (28%). Abdolhamizadeh et al. (2011) found that fire was the initiating event in 43% of the domino accidents analyzed in their study. Hemmatian et al. (2014) report that fire was the primary event in 47% of the 330 domino accidents analyzed in the survey carried out.

In several past accident fires resulted from the escalation of a primary explosion. Still, in such events, further escalation of the secondary fires to affect other installations is often reported. In both the 2005 accident at the Buncefield oil storage depot in UK and the 2009 accident at the Caribbean Petroleum Corporation (CAPECO) in Puerto Rico, explosions were the primary event, but the secondary tank fires started immediately after the explosion led to further tank fires by the action of thermal radiation.

Safety barriers can prevent the escalation of fires, and some technical standards require the use of safety barriers to avoid or reduce the possibility of escalation (CCPS - Center of Chemical Process Safety, 2001). Safety barriers including fire detection systems and water deluge systems are widely used to reduce the probability of domino effect. Water deluge systems can provide cooling water to prevent

structural damage of equipment components caused by a nearby fire.

Even if safety barriers and safety systems may effectively mitigate or prevent escalation, several major accidents have shown that safety barriers may fail or be unable to play an adequate role in the accidents. The performance or effectiveness of the safety barriers in preventing escalation was studied by several researchers (Landucci et al., 2015; Janssens et al., 2015; Landucci et al., 2016; Khakzad and Reniers, 2017; Bucelli et al., 2018; Misuri et al., 2020; Sun et al., 2021). All these studies evidence that, even if the application of safety barriers and safety systems decreases significantly the risk of major accidents and of escalation, still a relevant residual risk may be present in specific types of installations.

Emergency response may be applied to reduce the residual risk of escalation and to obtain an improved prevention of fire escalation. Actually, emergency response can reduce accident losses, and previous studies evidenced its role in preventing domino effects (Zhou and Reniers, 2017; Zhou and Reniers, 2018).

Emergency response is restricted by many factors, and emergency resource (including emergency personnel) is an important factor influencing emergency response efficiency and even whether an emergency response can be carried out. The quantity, scheduling, and allocation of emergency resources may influence emergency response. Emergency resource allocation is to arrange the resources required for emergency response in order to deal with unexpected events, so that the emergency response process can be carried out efficiently. In the literature, there are some studies on emergency resource allocation. Table 1 shows the studies and corresponding methods used.

Table 1 Studies on emergency resource allocation

Reference	Research question	Method used
Su et al., 2016	Parallel allocation of multiple emergency resources to multiple concurrent events in natural disasters	A multiply constrained integer linear programming model and heuristic algorithm
Yeboah and Park, 2018	Allocation of fire engines from one district to another in response to multiple concurrent fire alarms	Survival analysis
Zhou and Erdogan, 2019	Firefighting resource allocation in response to wildfire	An integer two-stage stochastic goal programming

Du et al., 2020	Optimal emergency resources allocation for rescuing victims and preventing domino effects	A mathematical model and heuristic algorithm
Wang et al., 2020	Emergency power resources allocation in a distribution system under extreme natural disasters	A heuristic method
Ramalho et al., 2021	Reservoir allocation for forest fire fighting	Fuzzy logic, Euclidean distance, and network analysis
Zhang et al., 2021	Multi-target resource allocation under terrorist attack	A defender-attacker game

In the process industry, after a major fire accident occurs, the front-line firefighting force (responders as well as resources used) may not be enough to control the accident, and other firefighting forces are needed to support it. There is a problem in the allocation of firefighting forces between the front-line emergency response department and the backup departments. If enough firefighting force is allocated in each front-line department to deal with any accident, maintaining such a firefighting force requires a lot of cost and may cause unnecessary waste. With the support between firefighting departments, a fire department (or front-line fire department) can maintain as few firefighting forces as possible, but corresponding accidents can still be handled.

After the primary fire occurs, it is important to prevent the fire from escalating to other installations. The wall of the adjacent installations may be damaged under the action of thermal radiation. There is a heating process that the thermal radiation acts on the installation, so that the adjacent installations have a time from the occurrence of the fire to the damage, which is usually called time to failure (*t_{tf}*). To prevent the escalation of fire in the process industry, the main measure is to cool adjacent installations using water. Even if the fire force is insufficient to completely cool and protect all adjacent installations, it is possible to prolong the *t_{tf}* of the installations through partial cooling, so that the backups can join the cooling and firefighting before the failure of adjacent installations.

This study analyzes the allocation of front-line emergency force with the goal of preventing fire escalation. Taking into account the dynamic change of equipment *t_{tf}* in emergency response, common

resource allocation methods including those listed in Table 1 are difficult to apply to the emergency team allocation problem in this study. Considering the uncertainty in the emergency response process, this study uses Petri-nets to model the emergency response process to analyze the allocation of emergency response forces.

Petri-net is a powerful modeling tool with abundant system description and system behavior analysis techniques. It is a graphical and mathematical modeling tool which has basic components of places, transitions, and arcs. In addition, tokens are used in Petri-nets to simulate dynamic evolution and concurrent behavior of a system. A Petri-net is suited for modeling of dynamic systems with concurrent or parallel events and activities. **However, to date** this approach was not applied to the specific issue of the optimal allocation of **firefighting forces between frontline and backup departments** aimed at preventing domino effects.

The present study aims at using Petri-net (PN) to model the process of emergency response to major fires and to analyze the allocation of emergency forces taking into account the dynamic behavior of *tff* in the presence of multiple fire and/or as a consequence of changes in heat radiation due to firefighting action. The remainder of the paper is organized in seven sections. Section 2 introduces the related works, including those which will be used in this study. The approach for allocation analysis of emergency teams is presented in Section 3. In Section 4, a case study is introduced. The results of the case-study are reported in Section 5 and discussed in Section 6. Finally, some conclusions are drawn in Section 7.

2. STATE OF THE ART

In the following, an outline of the relevant state of the art and of related studies is provided.

2.1 Fire domino effect analysis

In the literature, fire-related domino effects are studied by some authors. Among others, Chen et al. (2018) apply a Domino Evolution Graph (DEG) and a Minimum Evolution Time (MET) algorithm to model the spatial-temporal evolution of domino accidents. Zhang et al. (2019) analyze the probability of domino accident chains based on statistical data. He and Weng (2020) use the field theory and Monte Carlo simulation to assess the risk of domino accidents. Wu et al. (2020) propose a simplified model for the calculation of the tank *tff* with respect to the thermal radiation intensity, filling level and safety protections. Zeng et al. (2020) apply the dynamic Bayesian network to analyze the propagation patterns and probabilities of domino effects. Huang et al. (2021) use matrix calculation combined with Monte

Carlo simulation to analyze the dynamic evolution of domino effects. Ovidi et al. (2021) uses agent-based model and simulation approach to analyze domino effects with add-on protections. More recently, Cui et al. (2022) apply Bayesian network to analyze the probability of accident chains of a tank farm.

Escalation of primary fires is normally caused by the action of thermal radiation generated by the fire on nearby process or storage equipment. In particular, under the action of thermal radiation, structural elements as the shell or the supports of nearby equipment are heated. As the temperature rises, the performance of the material used for the structural elements may deteriorate, finally causing structural damage and loss of containment from the installation. As an example, the EN1993-1-2 (1993) standard shows that when the temperature increases to more than 400°C, the strength of the steel decreases and may cause the collapse of the structure. A study from Cozzani et al. (2006) identified the radiation thresholds above which process or storage equipment is likely to experience damage leading to domino effect and escalation.

Some researchers have investigated the intensity of thermal radiation that may cause damage to a nearby installation. The escalation threshold of thermal radiation for different categories of steel storage tanks varies from 9.5 to 38 kW/m² (Cozzani et al., 2006), and a few authors suggest to consider an escalation threshold of 15 kW/m² for cylindric vertical atmospheric vessel with a flat bottom and of 50 kW/m² for horizontal cylindrical pressurized vessels supported by saddles (Cozzani et al., 2006; Khakzad, 2015; Chen et al., 2018).

A few studies report vulnerability models for the equipment damage probability due to thermal radiation. After a fire breaks out, the temperature of the surface exposed to fire of the adjacent installations will rise, due to the action of thermal radiation. The increase in temperature combined to internal pressure build-up may lead to the failure of equipment items exposed to fire. However, a time lapse is present between the start of the fire and the structural failure of the equipment. The *t_{tf}* is related to the amount of thermal radiation received. Most equipment damage probability analysis in fire induced domino effects are based on the estimation of *t_{tf}*, and the equipment vulnerability model proposed by Cozzani et al. (2005) is (Cozzani et al., 2005; Antonioni et al., 2009; Kadri and Chatelet, 2013; Cozzani et al., 2014; Khakzad et al., 2014; Necci et al., 2015):

$$\text{Atmospheric vessel: } \ln(t_{tf}) = -1.128 \times \ln(Q) - 2.667 \times 10^{-5} \times V + 9.877 \quad (1)$$

$$\text{Pressurized vessel: } \ln(t_{tf}) = -0.947 \times \ln(Q) - 8.835 \times V^{0.032} \quad (2)$$

where *Q* is the thermal radiation received by the vessel (kW/m²), and *V* is the vessel volume (m³).

In most studies on domino effects, Probit models are used to relate ttf to probabilities.

2.2 Dynamic behavior of ttf with respect to thermal radiations changes in time

During emergency response, the intensity of the thermal radiation may change in time, due to the different forces displayed and to the different firefighting actions. Thus, the equations Eq. (1) and Eq. (2) may no more be used to calculate the ttf . In a previous study by (Zhou et al., 2021), based on Eq.(1) and (2), a critical “thermal dose” CD_{th} was defined, needed to cause the vessel failure. The critical thermal dose, CD_{th} , is defined as follows:

$$CD_{th} = Q^\alpha \cdot ttf \quad (3)$$

where α is a constant. For an atmospheric vessel, based on Eqs. (1) and (2) the critical thermal dose may be calculated as follows:

$$CD_{th} = Q^{1.128} \cdot ttf = e^{-(2.667 \cdot 10^5 \cdot V - 9.887)} \quad (4)$$

For a pressurized vessel the critical thermal may be calculated as follows:

$$CD_{th} = Q^{0.947} \cdot ttf = e^{-(8.835 \cdot V^{0.032})} \quad (5)$$

In case the thermal radiation received by the target vessel varies with time, the “thermal dose” received by the vessel may be calculated and compared to the critical thermal dose to assess vessel failure. The following expression is inferred for determining the thermal dose in case a variable thermal radiation is present:

$$CD_{th} = \int_0^t Q^\alpha dt \quad (6)$$

Eq. (6) may be discretized assuming that the thermal radiation received by the target vessel may be considered constant until a new fire occurs or a new firefighting action, causing the variation of the incident radiation, is applied:

$$CD_{th} = \sum_{i=1}^n Q_{o,i}^\alpha \cdot \Delta t_i \quad (7)$$

where $Q_{o,i}$ is the thermal radiation value received by the target vessel during the time interval i , Δt_i is the duration of the time interval i and n is the number of time intervals considered. The overall radiation received by the target vessel after the n -th change in incident radiation, $Q_{o,n}$, may thus be expressed as:

$$Q_{o,n} = \sum_{j=1}^m Q_j \quad (8)$$

where Q_j is the amount of heat radiation received by the target vessel in the i -th time interval from the j -th fire, and m is the total number of fires active during time interval n .

Since the critical thermal dose CD_{th} can be calculated by Eq. (4) or Eq. (5) and its value is a constant,

the *tff* of the vessel can be calculated using Eq.(7) if all fire occurrence times are known. Thus, the *tff* after the *n*-th fire occurs can be calculated as follows:

$$tff = \sum_{i=1}^{n-1} \Delta t_i + \Delta t \quad (9)$$

where Δt is the *n*-th time interval representing the time period from the occurrence of the *n*-th fire to the failure of the vessel, and $\Delta t_i = t_i - t_{i-1}$ is the time interval from the occurrence of the *i*-th fire to that of the (*i*-1)-th fire. The value of Δt may also be calculated from Eq.(7), assuming that the thermal dose equals the critical thermal dose obtained from Eq. (4) or Eq. (5) for the target vessel:

$$\Delta t = \frac{CD_{th} - \sum_{i=1}^{n-1} Q_{o,i}^{\alpha} \Delta t_i}{Q_{o,n}^{\alpha}} \quad (10)$$

Clearly enough, in the proposed approach the *tff* depends on the variation with time of the incident radiation, due to new fires occurring, to the extinguishing of one or more fire, or to firefighting actions attenuating the incident radiation. Therefore, the *tff* needs to be calculated considering the fire dynamics and the fire response.

2.3 Petri-net based modeling and simulation approach

There are some extensions to Petri nets depending on the problem to be solved. Timed Petri-net (TPN) considers that the execution of transitions or the retention of tokens in places has certain duration, so that the time characteristics can be included in model specifications (Zuberek, 1991). Colored Petri-Net (CPN) takes into account data types which are named colors, and functions and modules to model systems (Jensen and Kristensen, 2015). Hybrid Petri-net (HPN) extends the basic Petri-net to model continuous and discrete behaviors of a system (Ghomri and Alla, 2007). Various types of Petri-nets have been used in process industries (Grunt and Bris, 2015; Kamil et al., 2019; Li et al., 2019; Taleb-Berrouane et al., 2020; Duenas Santana et al., 2021), also in the framework of emergency response planning (Li et al., 2016; Zeng et al., 2016; Zhou and Reniers, 2017; Zhou and Reniers, 2018; Luo et al., 2019; Duan et al., 2020; Zhou and Reniers, 2020).

In previous studies (Zhou and Reniers, 2016; Zhou and Reniers, 2018), the timed colored hybrid Petri-net (TCHPN) is defined as an eleven-tuple:

$$TCHPN = (P, T, A, \Sigma, V, N, C, G, E, IN, \tau) \quad (11)$$

(1) *P*: is a finite set of places, which includes two subsets P_D and P_C , representing the discrete and the continuous places, respectively.

(2) *T*: is a finite set of transitions, which includes a subset of discrete transitions T_D and a subset of

continuous transitions T_C . A continuous transition can impact system state continuously over time, while a discrete transition influences the system state only when it is executed.

- (3) $A \subseteq P \times T \cup T \times P$: is the set of directed arcs which connect places and transitions.
- (4) Σ : represents the set of colors which are non-empty types.
- (5) V : is the set of variable types, satisfying that a variable type belongs to Σ for all $v \in V$ variables.
- (6) $N: A \rightarrow P \times T \cup T \times P$ is a node function.
- (7) $C: P \rightarrow \Sigma$ is the functions which assign a color set to corresponding place.
- (8) G : is a set of guard functions that assign filters or restrictions to transition t .
- (9) E : is a set of arc functions which assign expressions to arcs.
- (10) IN : is an initialization function.
- (11) τ : is a function that assigns time delays to discrete transitions.

Petri-net is a graphical modeling tool, such that the elements in TCHPN are denoted by icons, as shown in Fig. 1.

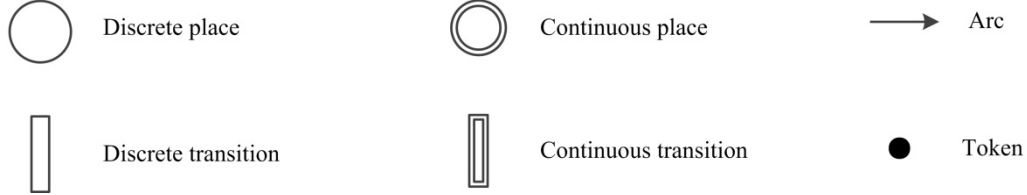

Fig. 1 Elements in a TCHPN model (Zhou and Reniers, 2018)

In a Petri-net model, the marking M represents the state of it. The marking of a Petri-net is defined as a set of the number of tokens with respective colors contained in all places. The initial marking is usually denoted as M_0 which is the marking determined according to the initialization function.

A Petri-net model is executable, based on its enabling and execution/firing rules. For ease of expression, it indicates places connected from a transition t as t^* , and places connected to transition t as *t . Similarly transitions connected from place p are noted as p^* , and transitions connected to place p as *p .

A transition t is enabled when each input place contains at least the number of tokens with correct colors required by the arc connecting from the place to transition t . More than one transition can be enabled concurrently if there are enough tokens with corresponding colors in all input places.

If a transition is enabled, it can be executed according to the execution rules. The execution of a transition t changes the marking of the Petri-net model from M to M' .

(i) Execution rule of a discrete transition

For a discrete transition t with execution duration d , the marking is changed at the beginning of the execution of transition t :

$$M'(p_i) = M(p_i) - E(p_i, t), \text{ for } p_i \in {}^*t \quad (12)$$

At the end of the duration d , the marking is changed according to:

$$M'(p_i) = M(p_i) + E(t, p_i), \text{ for } p_i \in t^* \quad (13)$$

Where, $E(p, t)$ and $E(t, p)$ represent tokens determined by the expression of the input arc and output arc, respectively.

This rule indicates that the execution of a timed discrete transition will remove tokens with appropriate colors from its input places which are determined by the input arcs. The execution of a timed discrete transition lasts for a certain time, and tokens with proper colors are created in its output places after the execution. It should be noted that the removing of tokens from input places occurs at the beginning of the execution, and the creating of tokens in output places occurs at the end of the execution.

(ii) Execution rule of a continuous transition

$$M'(p_i) = M(p_i), \text{ for } p_i \in {}^*t \text{ and } M'(p_i) = M(p_i), \text{ for } p_i \in t^* \quad (14)$$

After a continuous transition t is enabled, it can execute continuously. The execution of a continuous transition does not change the number of tokens in any place it connects, but only the value of the color variable of a token in the input or output place.

3. MODEL

3.1 Allocation problem

When emergency responders, such as firefighting teams, arrive at the scene, they can both fight the fire and take measures to prevent fire escalation. In particular, the use of fire monitors to cool down the nearby installations is a preventive measure widely applied to reduce the probability of escalation.

Previous studies considering the role of emergency response in the prevention of domino effect mostly assumed that when the firefighting teams arrive at the scene, there are sufficient fire-fighting resources to prevent the escalation of the fire. In practice, when responding to a major fire accident, the

firefighting teams arriving at the fire scene first may not be sufficient to control the fire and may need backups. Thus, in major fire accidents, an allocation problem of fire-fighting resources (firefighters and corresponding facilities) arises. Actually, if the front-line firefighting force is too small, the fire may escalate as it cannot be controlled before the backup resources arrive at the scene. On the contrary, in the absence of a specific assessment, there may also be the possibility that the front-line emergency is over equipped by emergency forces. Therefore, optimizing the allocation of emergency response forces is a task of extreme importance to further increase safety standards aimed at the prevention of domino effect leading to escalation and to optimize the display of firefighting resources.

It can be seen from Eq.(1) and Eq.(2) that when the volume of a vessel remains constant, the *t_f* of the vessel is related to the thermal radiation received. If measures are taken to reduce the thermal radiation received by an adjacent vessel after the primary fire, the *t_f* of the vessel can be prolonged. Therefore, the impact of fire emergency response forces on vessel *t_f* should be considered when analyzing the allocation of fire forces between the front-line emergency response department and backup support departments. If the actions of the front-line department prolong the *t_f* of vessels adjacent to a fire, the possibility that backup forces arrive on the scene to participate in the firefighting before the vessels are damaged can be improved. One principle of fire emergency response is that controlling a fire takes a high priority over extinguishing it. When allocating emergency forces to the front-line emergency response department, it can be considered that the most important task of the front-line emergency response department is to prevent the escalation of fire, namely, cooling adjacent vessels. The fire extinguishing can be reserved until the backup force arrives and enough firefighting force is available.

Obviously, the time at which the front-line emergency department starts to cool adjacent vessels and the emergency force amount of the front-line emergency department engaged in fire controlling (cooling adjacent vessels) have an impact on the *t_f* of the vessels. If the force is sufficient and they take part in the cooling before the damage of vessels, all adjacent vessels are fully protected and the vessels can be considered not to be damaged; If the force put into cooling is not enough to fully protect the vessels, then the later the emergency force is put into cooling, the more thermal radiation the vessel receives, and the less time the *t_f* is prolonged. On the contrary, if the front-line emergency force is put into cooling vessels earlier, the vessel *t_f* will be prolonged more time. Therefore, *t_f* is dynamic under the emergency response action. Using the dynamic characteristic of *t_f*, it is possible that only an appropriate amount of emergency force in the front-line emergency department is allocated, so that after a fire occurs, the *t_f* of adjacent

vessels can be prolonged until the backup force arrives at the scene. Thus, a comparable emergency response level can be kept, and the operating costs of the front-line department can be reduced as much as possible. As the backups can support multiple front-line emergency departments, this work focuses on the allocation of emergency forces in front-line emergency departments.

The following main factors can influence the allocation of emergency response teams:

(i) The time from the occurring of a fire to the cooling of nearby vessels after the front-line emergency response teams arrives at the scene. The arrival time of the emergency teams is different, and the adjacent facilities are influenced by heat radiation to different degrees.

(ii) Thermal radiation received by vessels adjacent to the fire. As a main escalation vector, the thermal radiation received by a vessel influences its *t_{tf}*.

(iii) The volume of material stored in the vessels adjacent to the fire. According to Eq. (1) and Eq. (2), the volume also influences the *t_{tf}* of the neighboring vessel.

(iv) Cooling capacity of the front-line emergency response teams. This can be simply considered to be related to the number of the front-line emergency teams.

(v) The time from receiving a support request by the backup teams to cooling vessels after they arrive at the scene.

Factors (i) to (iv) will influence the *t_{tf}* of vessels adjacent to a fire and factor (v) determines whether the backup can arrive in time.

3.2 Allocation analysis of emergency teams

In this study, the allocation of emergency response forces is analyzed to the end of the prevention of fire escalation. The front-line emergency response department can increase the *t_{tf}* of facilities adjacent to a fire according to Eq.(9) and Eq.(10), so that backup forces may have the time to arrive and be displayed, cooling down the facilities before their failure. An emergency response team (e.g. a fire truck and related firemen) is assumed as the unit of an emergency response. Changing the number of emergency response teams of the front-line emergency response department will change the probability (*Pr*) of preventing a fire from escalation. Suppose the relationship between the success probability of emergency response (*Pr*) and the number of emergency response teams (*k*) in the front-line department is expressed as:

$$Pr = f(k) \tag{15}$$

The goal of allocating emergency forces to the front-line emergency departments is to reduce the operating costs of the front-line departments as much as possible, which can be looked as reducing the number of emergency responders/teams in the front-line departments as much as possible; at the same time, it is necessary to improve the success probability of emergency response as much as possible. The goal of the emergency teams allocation can be expressed as:

$$\min k \quad \text{and} \quad \max Pr \quad (16)$$

There is a positive correlation between the number of emergency teams k and the probability of success Pr . When k increases, the tff of facilities near the fire will be extended longer, and the backups are more likely to arrive in time to protect the facilities, thus the success probability will increase. This is a multi-objective optimization problem, but unlike general optimization problems, the relationship between arriving times, cooling capacity and equipment tff is not deterministic, it is difficult to express the allocation of emergency teams with a clear analytical relationship. Therefore, this study adopts the approach of simulation analysis to determine the allocation of emergency response teams, and the TCHPN is used for the allocation analysis due to its advantages of modeling and time analysis. Transitions are used to represent emergency response actions, and places represent states. Tokens with colors are used to transmit information, e.g., number of emergency teams.

The principle of the analysis is to simulate the emergency response process, and compare the time of the emergency process with the tff of the nearest facilities adjacent to the fire. The emergency response teams often arrive at different times, thus after a team arrives, the tff of the adjacent facilities will change dynamically due to the cooling action. Therefore, the time when sufficient emergency response teams arrive at the scene to control the escalation of the fire is compared to the final tff of the adjacent facilities. If the former is less than the facility tff , it is considered that the fire escalation is successfully prevented, and the emergency response is successful, otherwise the emergency response is considered a failure. Monte-Carlo simulation is used to determine the success probability of emergency response. Through a large number of trials, the number of successful emergency responses is counted and it is compared with the total number of simulations to obtain the probability of successful emergency response. The steps for calculating the success probability when the front-line department has k emergency response teams are shown in Fig. 2.

Step 1. Initialization. Set the number of total simulation, the number of emergency response teams in the front-line department, etc.

Step 2. Sampling. Sample the duration of emergency response actions according to certain probability distribution. For emergency response to fires, the duration of actions was discussed in previous studies (Peng, 2010, Zhou and Reniers, 2016). It was shown from statistical analysis that the duration of emergency response actions satisfies a lognormal distribution. Thus, in this study, the duration of all emergency response actions is sampled using corresponding lognormal distribution functions.

Step 3. Simulation. Simulate the emergency response process. Usually the teams of the front-line department arrive at the fire scene first, thus the *t_{ff}* of the facilities adjacent to the fire needs to be recalculated based on the arrival time and the number of teams arriving. The simulation continues until enough backup emergency response teams arrive at the scene.

Step 4. Calculation. After a given number of simulations are completed, the number of successful emergency responses is counted, and it is compared with the total number of simulations. Therefore, the success probability of emergency response can be obtained.

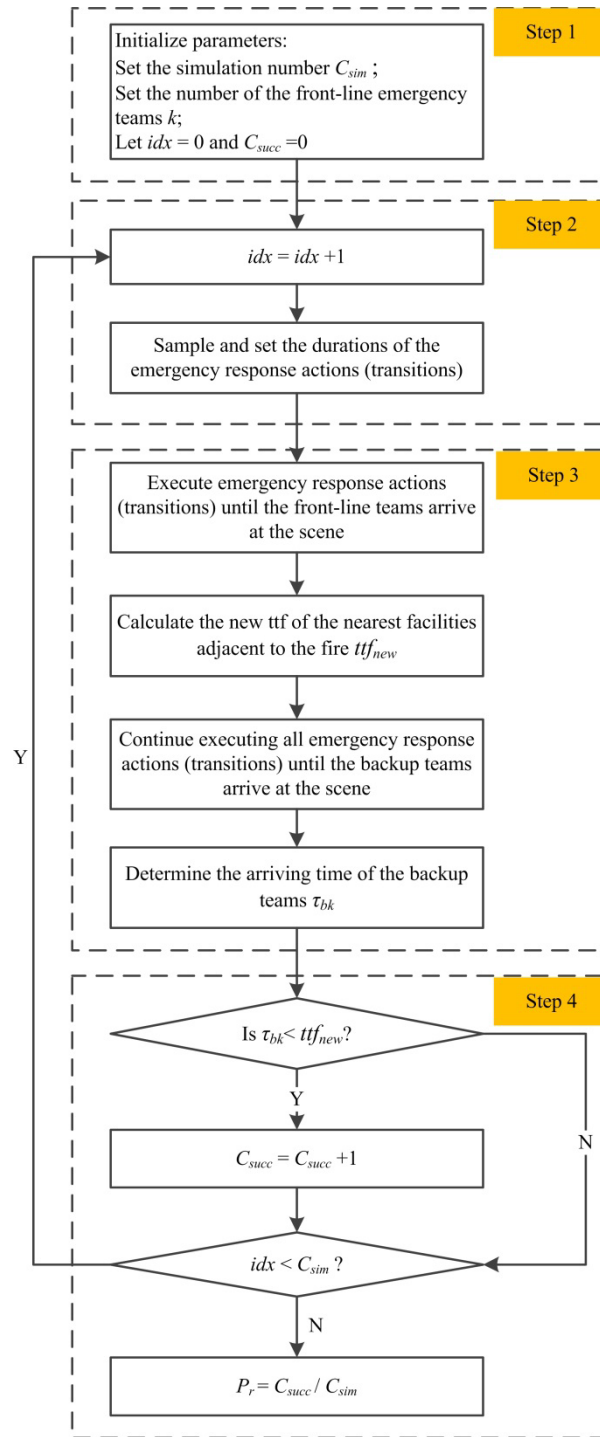

Fig. 2 Steps to calculate the probability of successful emergency response

To make a trade-off between the number of emergency teams and the success probability of emergency response, the marginal effect of the number of emergency teams can be used to make a decision. The marginal effect (Me) of increasing the number of emergency response teams (k) of the front-line emergency response department can be defined as:

$$Me = dPr/dk \quad (17)$$

The value of Me indicates the effect of increasing the number of emergency teams of the front-line department on the probability of success. A small value of Me indicates that it is difficult to increase the probability of success by adding a team. Thus, combining the marginal effect and the success probability of emergency response (e.g. a required probability), an appropriate number of emergency teams may be identified.

The success probability of preventing the escalation of a fire can be obtained through simulation analysis based on the TCHPN model of the emergency response to the fire.

4. CASE-STUDY

4.1 Definition of Case-Study

For illustrative purposes, a fire occurring in a storage tank area is considered. The layout of the tank area is shown in Fig. 3. Diesel oil is stored in atmospheric tanks Tk1~Tk6, and each tank has a radius of 10 meters and a height of 10 meters. The distance from Tk1 to Tk2 is 35 m (center to center), and so is the distance from Tk1 to Tk3. The fires in these tanks are regarded as pool fires. The thermal radiation intensities from to any other tanks are shown in Table 2.

The development of a fire occurring at a tank storing flammable materials and the corresponding emergency response process are very complex. For illustrative purposes, in this study the following assumptions are made to simplify the problem of analysis:

(A) Emergency response is only based on fire trucks from external fire departments and that no water deluges or fire monitors are installed. This is also the worst-case consideration, even if there are water deluge systems, they may fail or be damaged in an accident.

(B) The thermal radiation value received by one storage tank from the other is a constant. In actual fires, thermal radiation may be constantly changing, affected by factors such as wind direction and speed. In this work, the thermal radiation between two tanks is considered to be fixed as in many domino effect studies. Only emergency response (cooling action) can change the thermal radiation received by a tank. Table 2 lists the thermal radiations from one tank to other tanks.

(C) The volume of material stored in the adjacent tanks remains constant during the fire accident. Thus, the tff of a tank is only related to the thermal radiation it receives.

(D) All emergency response teams are the same. A fire department has fire teams which have the same fire truck with the same number of firemen. Thus, the study focuses on the allocation of the number of emergency response teams.

(E) The cooling capacity of each emergency team is the same and each fire truck has one fire hose nozzle for cooling, and its water is continuously supplied through the fire hydrant around. Although a fire truck may have multiple fire hose nozzles, the number of fire hydrants around a fire site usually cannot guarantee continuous water supply for multiple fire hose nozzles of each fire truck. If multiple fire hose nozzles of the fire truck consume water simultaneously and the water cannot be supplied continuously, the fire truck needs to frequently go to nearby fire hydrants or other water replenishment devices to replenish water, thereby influencing the cooling efficiency. Thus, to simplify the problem, a fire truck is considered to have only one fire hose nozzle to determine the number of fire trucks.

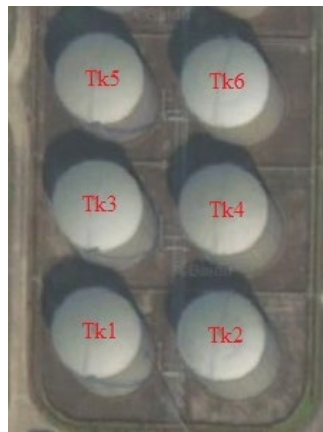

Fig. 3 Layout of tanks

Table 2 Thermal radiation escalation vectors (kW/m²)

	Tk1	Tk2	Tk3	Tk4	Tk5	Tk6
Tk1	-	15.2	15.2	7.2	3.4	2.6
Tk2	15.2	-	7.2	15.2	2.6	3.4
Tk3	15.2	7.2	-	15.2	15.2	7.2
Tk4	7.2	15.2	15.2	-	7.2	15.2
Tk5	3.4	2.6	15.2	7.2	-	15.2
Tk6	2.6	3.4	7.2	15.2	15.2	-

Two different scenarios were considered for the analysis of the case-study:

4.2 Scenario 1

A first scenario considered for the analysis of the case-study assumes that there are two fire departments that may respond to an accident occurring in this tank area. Fire department one (FD1) is the front-line fire department, located 2 km to the tank area. In case of an accident in the storage area, FD1 should dispatch fire teams to deal with it as soon as possible. If the incident is severe, FD1 may not be able to handle it alone, so the support from fire department two (FD2) is needed, and FD2 is 6 km away from the tank area.

Take 15kW/m^2 as the threshold of fire escalation, and consider the emergency response process when Tk3 catches fire. After the fire is discovered, the fire department FD1 first receives the fire alert, and sends fire teams to the scene. When fire teams of FD1 arrive at the scene, they evaluate the fire and, if necessary, issue a request to FD2 for support, and arrange for the fire teams of FD1 to fight (cooling the nearby tanks and trying to extinguish the fire). FD2 sends teams to the scene upon request for support, and after the teams arrive at the scene they take part in the fire-fighting (saving property and wounded, cooling adjacent tanks and trying to extinguish the fire) according to the fire state.

4.3 Scenario 2

In the second scenario considered, it is assumed that the request for support from FD1 is sent before the fire teams of FD1 arrive at the scene and evaluate the fire scenario. Actually, if the request is sent earlier, it can also improve the success rate of emergency response. As soon as the fire is discovered, the emergency response department receives the alarm and decides whether or not to send request to the backups. If the backups are needed, the fire teams of FD2 should be notified at the same time as those of FD1. This can greatly shorten the time for the teams of FD2 to get to the scene and start cooling.

5. RESULTS

5.1 Results obtained from the analysis of Scenario 1

The Petri-net model of the emergency response process is established as shown in Fig. 4. The definitions of the places and the transitions of the model are shown in Table 3 and Table 4, respectively.

In this model, a place can hold at most one token. Some parameters in the emergency response, such

as the number of emergency teams, the state of the fire, etc., are reflected by the color of the token. tn is an integer color variable representing the number of emergency teams, and fs is also an integer color variable representing the fire state. The compound color (tn, fs) represents both the number of emergency teams and the fire state; and the compound color (tr, ttf) is composed of two color tr (thermal radiation) and ttf of the real type.

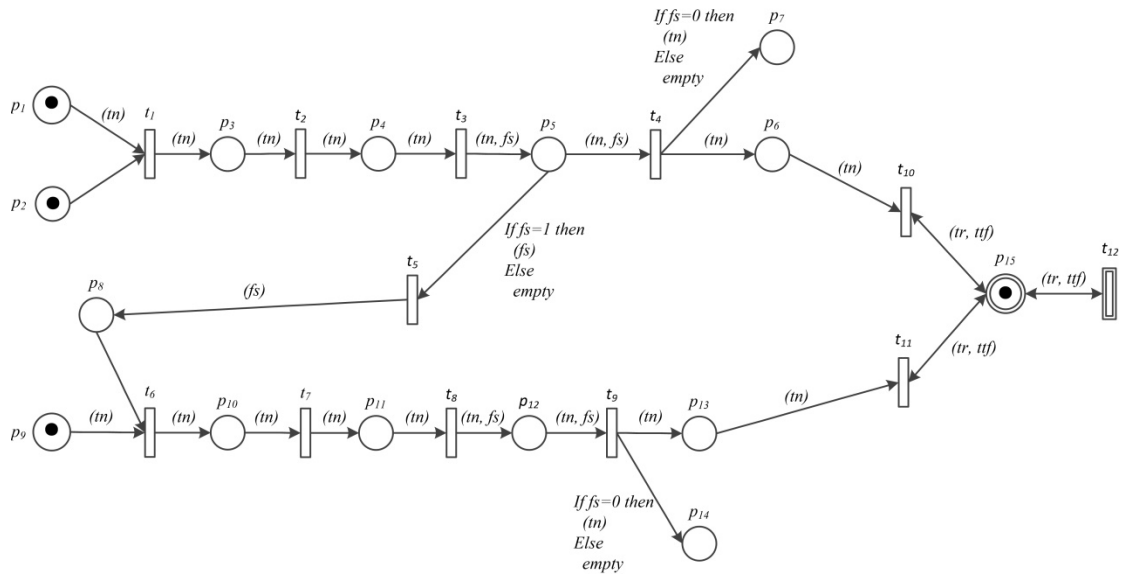

Fig. 4 Petri-net model of the emergency response process

Table 3 Definitions of places of the Petri-net model in Fig. 4

Place	Meanings	Place	Meanings
p_1	FD1 is on duty	p_9	FD2 is on standby
p_2	Occurrence of the fire	p_{10}	Fire teams of FD2 are ready
p_3	Fire alarm is received by FD1	p_{11}	Arriving of fire teams of FD2
p_4	Arriving of fire teams of FD1	p_{12}	Evaluation result with teams of FD2
p_5	Evaluation result is obtained	p_{13}	The task of cooling tanks
p_6	The task of cooling adjacent tanks	p_{14}	The task of extinguishing fire
p_7	The task of extinguishing fire	p_{15}	State of the adjacent tank
p_8	Request of backups		

Table 4 Definitions of transitions of the Petri-net model in Fig. 4

Transition	Meanings	Transition	Meanings
t_1	Detect fire and send alarm to FD1	t_7	Fire teams of FD2 sped to the scene
t_2	Fire teams of FD1 sped to the scene	t_8	Evaluate fire state with fire teams of FD2
t_3	Evaluate fire state with fire teams of FD1	t_9	Assign tasks to fire teams of FD2
t_4	Assign tasks of fire teams of FD1	t_{10}	Change the thermal radiation and ttf of adjacent tank
t_5	Request for backups	t_{11}	Change the thermal radiation and ttf of adjacent tank
t_6	Dispatch backups from FD2	t_{12}	Change ttf of adjacent tank over time

There is a continuous place p15 in the model, where the tokens need to have a compound color (tr, ttf). It always has a token in it, but the color value of the token may change, representing the changing of the state of the adjacent tank. The execution of transitions connecting to it can update the color value of the token, and cannot generate a new token in it. The function of the continuous transition t12 which is connected to p15 is similar to that of a timer, whose execution reduces the value of ttf . Transition t12 executes in unit time intervals in this work to express its continuous execution. Transitions t10 and t11 means that the received thermal radiation and the ttf of adjacent tanks should be updated after emergency teams of FD1 and FD2 take part in the tank cooling, respectively.

In this study, the relationship between the number of fire trucks and corresponding fire fighters and the received thermal radiation of adjacent tanks is investigated. A fire truck and the corresponding firemen (about 6) are considered to be a fire-fighting team.

(i) Simulation of emergency response process

The relationship between emergency teams taking part in tank cooling and the received thermal radiation of the adjacent tank can be roughly determined by cooling water consumption. According to the standard for fire prevention design of petrochemical enterprise (Ministry of Housing and Urban-Rural Development of the People's Republic of China, 2019), when using a mobile fire hose nozzle to cool a vertical storage tank storing flammable liquid near a fire tank, the water supply intensity is 0.7 L/s·m,

and the full length of the tank circumference is required for the calculation of the cooling water demand. In this study, the tank circumference is about 31.3m, such that the amount of water required to cool a tank is 1319 L/min. As the water velocity of a fire hose nozzle of a fire truck is about 500 L/min, thus three fire trucks are needed to cool a storage tank. Therefore, it can be estimated that if Tk3 is on fire, nine fire trucks are required to fully cool the three adjacent tanks to prevent them from being damaged by thermal radiation.

In this scenario, it is assumed that FD1 has four fire teams, and FD2 has enough fire teams for backup. At the beginning of the fire accident, each of places p1, p2, p9 and p15 has a token, and all other places have no token. Thus, the initial marking is $M_0=(1,1,0,0,0,0,0,0,1,0,0,0,0,0,1,0)$. The marking changes with the execution of the transitions, reflecting the change of the system state. It is important to remark that in this model the timed discrete transition removes tokens from their input places at the beginning of its execution, and generates tokens in the output places at the end of the execution.

The simulation process ends when there are no enabled discrete transitions, or the value of tff in place p15 is decreased to 0. After a simulation, the tff value of the token in place p15 is used to assess whether the emergency response is successful. Since all four fire trucks of FD1 are not enough to cool adjacent tanks and to keep them from heating, a support of FD2 teams is needed to control the escalation of the fire. If fire teams of FD2 arrive at the fire scene and joins in the tank cooling before the tff of the adjacent tank becomes zero, the thermal radiation received by the adjacent tank can be considered to become zero and the tff becomes infinite, so the emergency response process is successful. Otherwise, the emergency response process is considered to be a failure.

The discrete transitions can have a duration in a TCHPN model, and lognormal distributions are used to sample the duration of emergency response actions. The average duration of the transitions is: t1: 2.5 min; t2: 3 min; t3: 1 min; t4: 1 min; t5: 1.5 min; t6: 1.5 min; t7: 6 min; t8: 1.5 min; t9: 1.5 min.

Transitions t10 and t11 are considered as immediate transitions whose execution duration is zero. These transitions only change the state of the system and do not represent specific emergency response actions. They determine the need to recalculate the value of the tff of the nearby tanks based on the cooling actions.

According to the distribution function of the execution time of each transition, a sample set of duration values of the transitions is shown in Table 5, and the corresponding emergency response process is shown in Table 6. After Tk3 catches fire, the tff of adjacent storage tanks (Tk1, Tk4 and Tk5) is 14.014

minutes. The value of *t_{tf}* decreases during the process that fire teams of FD1 sped to the fire scene. At the 6th minute, the fire teams of FD1 arrive and begin the cooling of the tanks. The *t_{tf}* becomes 15.88 minutes as the thermal radiation received by adjacent tanks decreases. In the 5th minute, fire teams of FD1 issue a request for backup, and then fire teams of FD2 leave to join the fire scene. In the 18th minute (17.17 min to be exact), transition t11 is executed, meaning that fire teams of FD2 arrive at the scene and start cooling the equipment. At this time about four minutes are left before tank failure. With the complete cooling protection of adjacent tanks, the *t_{tf}* becomes infinity, which indicates that the fire escalation has been prevented and the emergency response is successful.

Table 5 Durations of transitions in the response to the fire accident

Transition	Duration	Transition	Duration	Transition	Duration	Transition	Duration
t1	0.780	t2	2.933	t3	0.516	t4	1.604
t5	0.629	t6	1.723	t7	9.122	t8	0.337
t9	1.133	t10	0	t11	0	t12	1

Table 6 Simulation of the emergency response process

Time	Marking	<i>t_{tf}</i> (min)	Executed transitions
0	(1,1,0,0,0,0,0,0,1,0,0,0,0,0,1,0)	14.014	
1	(0,0,0,0,0,0,0,0,1,0,0,0,0,0,1,0)	13.014	t1, t2, t12
2	(0,0,0,0,0,0,0,0,1,0,0,0,0,0,1,0)	12.014	t2, t12
3	(0,0,0,0,0,0,0,0,1,0,0,0,0,0,1,0)	11.014	t2, t12
4	(0,0,0,0,0,0,0,0,1,0,0,0,0,0,1,0)	10.014	t2, t3, t12
5	(0,0,0,0,0,0,0,0,0,0,0,0,0,0,1,0)	9.014	t3, t4, t5, t6, t12
6	(0,0,0,0,0,0,0,0,0,0,0,0,0,0,1,0)	15.877	t4, t6, t10, t12
7	(0,0,0,0,0,0,0,0,0,0,0,0,0,0,1,0)	14.877	t6, t7, t12
8	(0,0,0,0,0,0,0,0,0,0,0,0,0,0,1,0)	13.877	t7, t12
9	(0,0,0,0,0,0,0,0,0,0,0,0,0,0,1,0)	12.877	t7, t12
10	(0,0,0,0,0,0,0,0,0,0,0,0,0,0,1,0)	11.877	t7, t12
11	(0,0,0,0,0,0,0,0,0,0,0,0,0,0,1,0)	10.877	t7, t12
12	(0,0,0,0,0,0,0,0,0,0,0,0,0,0,1,0)	9.877	t7, t12

13	(0,0,0,0,0,0,0,0,0,0,0,0,0,0,0,1,0)	8.877	t7, t12
14	(0,0,0,0,0,0,0,0,0,0,0,0,0,0,0,1,0)	7.877	t7, t12
15	(0,0,0,0,0,0,0,0,0,0,0,0,0,0,0,1,0)	6.877	t7, t12
16	(0,0,0,0,0,0,0,0,0,0,0,0,0,0,0,1,0)	5.877	t7, t8, t12
17	(0,0,0,0,0,0,0,0,0,0,0,0,0,0,0,1,0)	4.877	t8, t9, t12
18	(0,0,0,0,0,0,0,0,0,0,0,0,0,0,1,1,0)	∞	t9, t11, t12

(ii) Probabilistic analysis

The model can be verified by simulation analysis of a single emergency response process. On this basis, the probability of emergency response can be analyzed by Monte Carlo simulation. Through 10000 trials, the probability of successfully preventing fire escalation when 4 fire FD1 teams are on the scene is 0.72. When FD1 has a different number of fire trucks/fire teams, the probability of successfully preventing the escalation of Tk3 fire is shown in Fig. 5. The results evidence that when FD1 has 6 fire trucks, the probability of success raises to 0.91, which is not much different from that of FD1 with 9 fire trucks (0.97). Since up to 9 fire trucks are needed to cool the neighboring tanks when Tk3 is on fire, FD1 can use up to 9 fire teams for cooling. However, the marginal effect of increasing fire trucks of FD1 to improve the probability of successfully preventing fire escalation becomes small when the number of fire trucks is equal to or greater than 6. The marginal effects are shown in Table 7. Given that the cost of a fire truck could be hundreds of thousands of dollars and that a fire truck would have to be staffed with about six firefighters, relevant cost saving without a significant reduction in emergency response levels would be obtained if FD1 has only six fire trucks available.

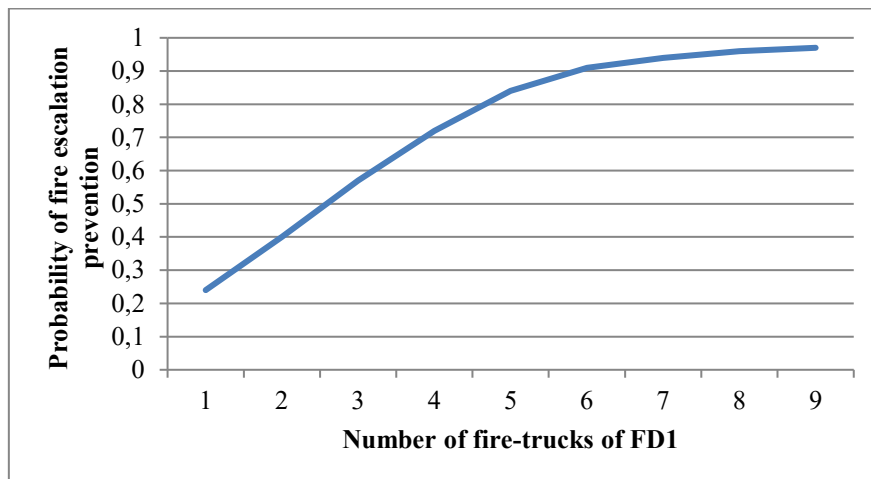

Fig. 5 Probability of fire escalation prevention as a function of the number of fire-trucks of FD1

Table 7 Marginal effect of increasing the number of fire trucks of FD1

Number of fire trucks	Marginal effect	Number of fire trucks	Marginal effect
1	0.16	2	0.17
3	0.15	4	0.12
5	0.07	6	0.03
7	0.02	8	0.01

5.2 Results of Scenario 2

The Petri-net model that adopts the improved emergency response strategy assumed in the second scenario considered is shown in Fig. 6, where t_5 indicates discovering fire and sending fire alarm information to emergency departments, p_{16} indicates the fire alarm information for FD1, and t_1 indicates that FD1 dispatches fire teams and p_3 means fire teams are ready to go. Other transitions and places remain unchanged. In this case, the duration distributions of transitions t_5 and t_1 are adjusted accordingly, and the average execution time of t_1 and t_5 is 1 minute and 2.5 minutes respectively.

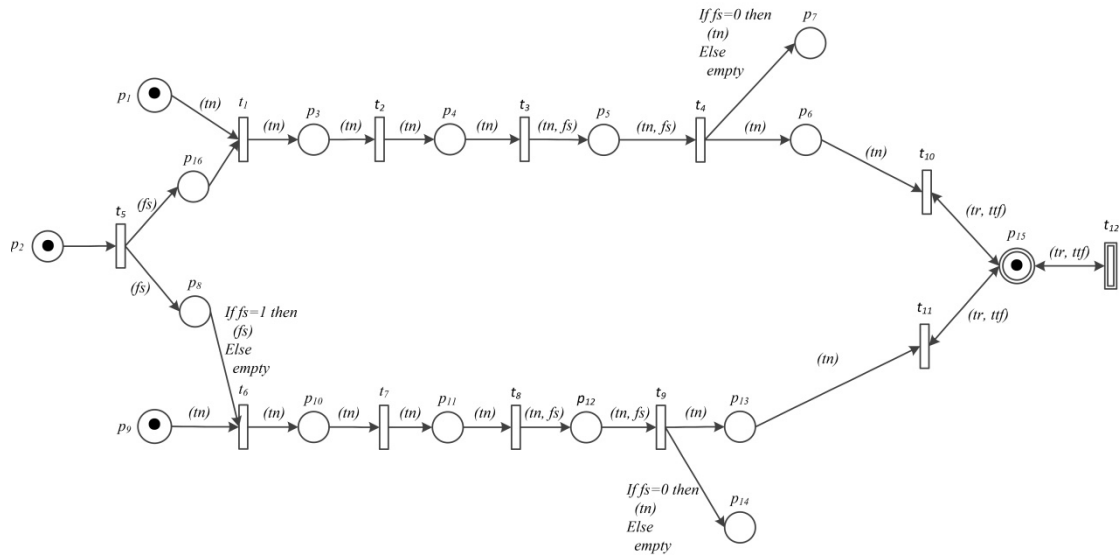

Fig. 6 Petri-net model of the improved emergency response strategy

Under the improved emergency response strategy, when fire teams of FD1 move to the fire site, fire teams of FD2 also move to the scene. Fire teams of FD1 are expected to arrive first and to take cooling protection measures that extend the t_{tf} of adjacent tanks, allowing for fire teams of FD2 to arrive before

failure of tanks. The relationship between the number of fire teams of FD1 used for cooling and the probability of preventing fire escalation with this improved fire response strategy are shown in Fig. 7. The marginal effects are shown in Table 8.

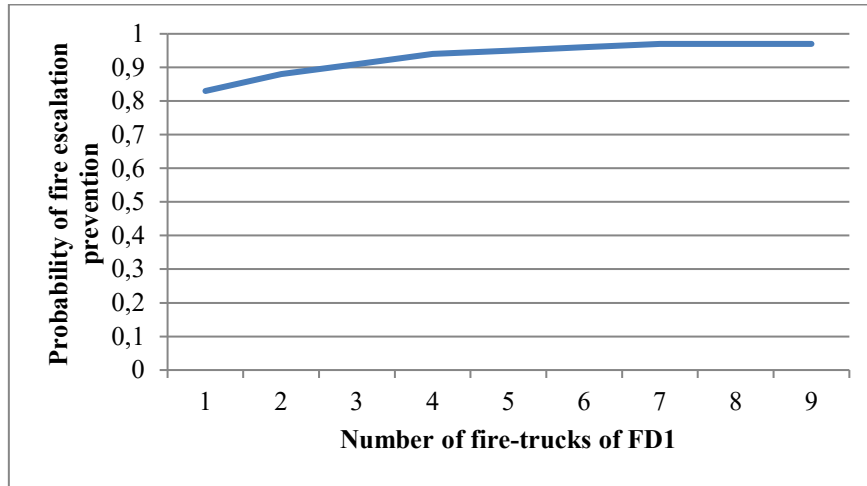

Fig. 7 Probability of fire escalation prevention under different number of fire-trucks of FD1 using the improved emergency response strategy

Table 8 Marginal effect of increasing fire truck of FD1 under the alter strategy

Number of fire trucks	Marginal effect	Number of fire trucks	Marginal effect
1	0.05	2	0.03
3	0.03	4	0.01
5	0.01	6	0.01
7	0.00	8	0.00

The probability of success under the new strategy is significantly higher than that of requesting support after the arrival of the fire teams of FD1. When FD1 has only three fire trucks for cooling, the probability of success is 0.91, and it is 0.94 for 4 cooling fire trucks of FD1. When the number of fire trucks of FD1 is seven, the success probability is 0.97, which is almost the same as that of nine fire trucks. From the marginal effects, when the fire trucks of FD1 is equal to or greater than 4, the increase of fire trucks of FD1 can hardly increase the success probability of the emergency response strategy. Therefore, considering the costs of the response, FD1 can be equipped with 4 cooling fire trucks, while the backup FD2 may be equipped with 5 fire trucks to obtain a sufficient emergency response. Comparing with the

marginal effects of the emergency response process shown in Fig. 4, equipping FD1 with two or three fire trucks would be acceptable when the marginal effect is considered, but four fire trucks have a better probability of success.

6. DISCUSSION

6.1 Factors influencing the optimal allocation of emergency response forces

The above study aims at providing a method for the optimal allocation of emergency response forces or teams when the layout of facilities (tanks and fire departments) has been determined. This is a common scenario for allocating emergency response forces. From the perspective of facilities layout design, the influence of other factors on the allocation of emergency response forces can also be analyzed.

On the basis of Scenario 2, assuming that FD1 is located in a different place, the allocation of emergency teams will be different from **that obtained in as a result of Scenario 2**. If the success probability of 0.9 is taken as the criterion, and the average travel time of the FD1 emergency teams from the time of setting out to the time of arriving at the fire scene is 2 minutes, and other factors in **Scenario 2** remain unchanged, FD1 should be equipped with 3 emergency response teams (the success probability is 0.93). If the average travel time of FD1 teams is 4 minutes, FD1 should have 4 emergency response teams and the success probability is 0.91.

The location of FD2 also influences the allocation of FD1 emergency response teams. Considering that the travel time of emergency teams in FD2 is changed, while other factors remain unchanged, the allocation of the FD1 emergency teams is also analyzed. When FD2 is farther away from the fire scene, FD1 needs to allocate more emergency teams to prolong the *t_{tf}* of the tanks adjacent to the fire as much as possible, so that the emergency teams of FD2 have enough time to arrive at the scene, and vice versa. When the average travel time of FD2's emergency response teams is 7 minutes, FD1 needs to allocate 4 emergency response teams to achieve a success probability of 0.91 in preventing fire escalation. When the average travel time of FD2's emergency response teams is 5 minutes, FD1 can achieve a success probability of 0.9 with only one emergency response team.

The thermal radiation received by an adjacent tank from the primary fire and the volume of the stored material determine the initial *t_{tf}* of the tank, which also impacts the allocation of emergency response teams. For example, if the layout of the tanks can be adjusted, changing the distance between the tanks will change the thermal radiation received by the adjacent tanks during a fire, and thus the *t_{tf}* of the

adjacent tanks will also change. Assuming that the distance between storage tanks (center to center) is 30 meters, when Tk3 catches fire, the thermal radiation received by adjacent tanks Tk1, Tk4 and Tk5 is 20 kW/m². The initial *t_{ff}* of these three tanks is 10.2 minutes. Using other parameters in Scenario 2, we can obtain the relationship between the number of emergency response teams and the success probability of preventing domino effects as shown in Fig. 8. It can be seen that in this case, even if FD1 is equipped with 9 fire-trucks (teams), the probability of success cannot reach 0.9. To improve the probability of success, other factors need to be adjusted, such as shortening the time to discover fire. Assuming that by installing automatic fire detection alarms, the time to discover fire is 0, then on the basis of Scenario 2, FD1 can be arranged with 3 fire-trucks (teams) to achieve a success probability of 0.9.

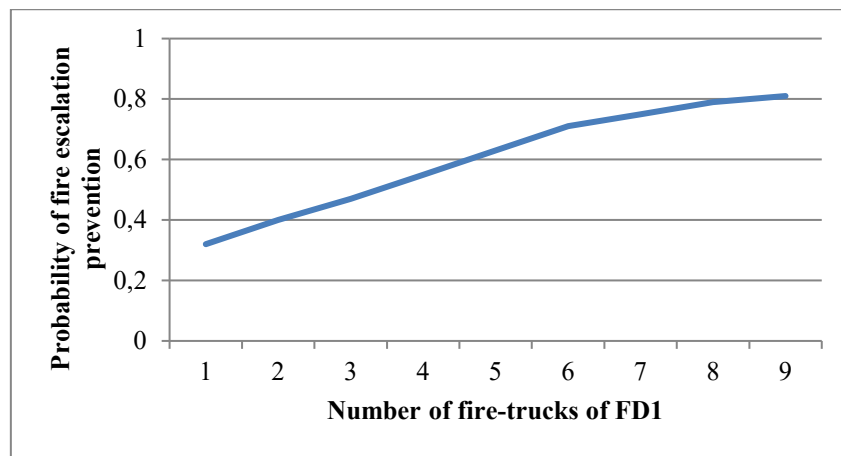

Fig. 8 Probability of fire escalation prevention under different number of fire-trucks of FD1 when thermal radiation received by the tank closest to Tk3 is 20kW/m²

6.2 Advancement of state of the art

Aiming at the prevention of the escalation of tank fires, this study discusses the optimal allocation of emergency response forces between the front-line emergency department and the backup department, taking into account the emergency response effect and the costs of emergency response.

The front-line emergency response teams and the backup emergency response teams usually arrive at the fire scene at different times. When the front-line emergency response teams take part in the tank cooling, the thermal radiation received by adjacent tanks will be reduced and the *t_{ff}* of the tanks will be prolonged accordingly, so that the backup emergency response teams have more time to get to the scene before the damage of adjacent tanks. Taking into account that the cooperation between the front-line emergency department and the backups, it can allocate as little emergency force as possible to keep a required emergency response level and reduce operation costs.

Although there have been many studies on the allocation of emergency resources, and emergency response personnel/teams are a special kind of emergency resources, some characteristics of emergency personnel/teams in emergency response make their allocation different from the allocation of ordinary emergency resources. The emergency response actions of emergency responders may influence the accident state, so the possible changes of the accident state should be considered when allocating emergency personnel/teams. Therefore, the usual static emergency resource allocation methods are not suitable for this situation. In this study, a method based on Petri net simulation analysis is proposed for the allocation of emergency forces between front-line and reserve departments, and can effectively solve this type of emergency personnel/emergency forces allocation problem considering cooperation.

6.3 Limitations of the method

The approach proposed in this work can allocate front-line emergency response teams considering the impact of emergency response on equipment t_{tf} in fire, but there are some areas for further study. In this study, the problem is simplified by assumptions, and to reflect the real fire development and emergency response process, there is still much work need to do, such as considering the safety barriers of facilities and their reliabilities, the allocation of different fire-fighting trucks in a fire department, complications in the use of cooling water for fire trucks, etc.

An emergency response process is composed of a series of emergency response actions. This work studies the success probability of emergency response through time analysis in order to facilitate the integration with changes of equipment t_{tf} , and the duration of each action satisfies a log-normal distribution which is estimated according to the statistics of historical emergency response data. Emergency response actions are carried out by people, thus human reliability has an important impact on the success of each action. Through human reliability analysis, the implementation of emergency response action by different emergency teams can be better reflected. This could be combined into the emergency team allocation model in the future studies.

7. CONCLUSIONS

Fires occurring in the petrochemical industry may escalate to other adjacent process or storage facilities. In order to prevent the escalation of a fire accident, emergency response is necessary in addition to safety barriers, as safety barriers may fail or be damaged during the accident.

This study addresses the allocation of emergency response forces between frontline and backup departments responding to tank fires, considering the emergency response actions of frontline emergency departments can prolong the damage time of adjacent facilities. A Timed colored hybrid Petri-net (TCHPN) based approach is proposed to model the emergency response process due to its advantages on modeling and analysis. Discrete and continuous transitions are used to represent discrete actions and continuous actions during the emergency response, respectively. Through the simulations carried out, whether an emergency response is successful can be reflected, and the success probability of the response can also be calculated considering a different allocation of fire response. The approach thus provides data of utmost importance to properly design emergency response considering the allocation of response teams in different locations.

A case-study based on a simplified description of emergency response is provided to illustrate the proposed approach. In the example, the fire needs at least nine cooling fire trucks to prevent fire escalation. Two alternative emergency response scenarios are discussed, and the appropriate allocations of emergency response teams between the front-line and the backup are analyzed. On this basis, in the case of changing the positions of the front-line fire department and the backup fire department (the average travel time changes), and the distance between the tanks (the thermal radiation received by the tanks changes), the optimal allocation of emergency teams for the front-line fire department is discussed.

From the analysis and the discussion it can be seen that the proposed method is able to not only support decision-making about the allocation of emergency teams, but also help to optimize the layout of emergency response departments. It can also provide guidance for improving emergency response actions, such as the use of automatic alarms to shorten the time to detect fires, and training responders to shorten the response time of other actions, to increase the success probability of emergency response.

Acknowledgment

This work is supported by National Natural Science Foundation of China (No. 71673060).

References

Abdolhamidzadeh B., Abbasi T., Rashtchian D., Abbasi S. A., 2011. Domino effect in process-industry accidents-An inventory of past events and identification of some patterns. *Journal of Loss Prevention*

- in the Process Industries 24, 575-593.
- Antonioni G., Spadoni G., Cozzani V., 2009. Application of domino effect quantitative risk assessment to an extended industrial area. *Journal of Loss Prevention in the Process Industries* 22, 614-624.
- Bucelli M., Landucci G., Haugen S., Paltrinieri N., Cozzani V., 2018. Assessment of safety barriers for the prevention of cascading events in oil and gas offshore installations operating in harsh environment. *Ocean Engineering* 158, 171-185.
- CCPS - Center of Chemical Process Safety, 2001. *Guidelines for Engineering Design for Process Safety*. American Institute of Chemical Engineers - Center of Chemical Process Safety, New York, NY.
- Chen C., Reniers G., Zhang L., 2018. An innovative methodology for quickly modeling the spatial-temporal evolution of domino accidents triggered by fire. *Journal of Loss Prevention in the Process Industries* 54, 312-324.
- Chen F.-Z., Zhang M.-G., Song J., Zheng F., 2018. Risk Analysis on Domino Effect Caused by Pool Fire in Petroliferous Tank Farm. *Procedia Engineering* 211, 46-54.
- Cozzani V., Antonioni G., Landucci G., Tugnoli A., Bonvicini S., Spadoni G., 2014. Quantitative assessment of domino and NaTech scenarios in complex industrial areas. *Journal of Loss Prevention in the Process Industries* 28, 10-22.
- Cozzani V., Gubinelli G., Antonioni G., Spadoni G., Zanelli S., 2005. The assessment of risk caused by domino effect in quantitative area risk analysis. *Journal of Hazardous Materials A127*, 14-30.
- Cozzani V., Gubinelli G., Salzano E., 2006. Escalation thresholds in the assessment of domino accidental events. *Journal of Hazardous Materials* 129, 1-21.
- Cozzani V., Reniers G., 2021. *Dynamic Risk Assessment and Management of Domino Effects and Cascading Events in the Process Industry*. Elsevier, Amsterdam. ISBN: 9780081028384
- Cui X., Zhang M., Pan W., 2022. Dynamic probability analysis on accident chain of atmospheric tank farm based on Bayesian network. *Process Safety and Environmental Protection* 158, 146-158.
- Darbra R. M., Palacios A., Casal J., 2010. Domino effect in chemical accidents: main features and accident sequences. *Journal of Hazardous Materials* 183, 565-573.
- Du Y., Sun J., Duan Q., Qi K., Xiao H., Liew K.M., 2020. Optimal Assignments of Allocating and Scheduling Emergency Resources to Accidents in Chemical Industrial Parks. *Journal of Loss Prevention in the Process Industries* 65, 104148.
- Duan H., Liu C., Zeng Q., Zhou M.C., 2020. Refinement-Based Hierarchical Modeling and Correctness

- Verification of Cross-Organization Collaborative Emergency Response Processes. *IEEE Transactions on Systems Man Cybernetics-Systems* 50, 2845-2859.
- Duenas Santana J.A., Orozco J.L., Lantigua D.F., Furka D., Furka S., Cruz A.G., 2021. Using integrated Bayesian-Petri Net method for individual impact assessment of domino effect accidents. *Journal of Cleaner Production* 294, 126236.
- EN1993-1-2 European Committee for Standardisation (CEN), 1993. Eurocode 3: Design of Steel Structures, Part 1.2: Structural Fire Design. CEN, Brussels.
- Ghomri L., Alla H., 2007. Modeling and analysis using hybrid Petri nets. *Nonlinear Analysis: Hybrid Systems* 1, 141-153.
- Grunt O., Bris R., 2015. SPN as a tool for risk modeling of fires in process industries. *Journal of Loss Prevention in the Process Industries* 34, 72-81.
- He Z., Weng W., 2020. A dynamic and simulation-based method for quantitative risk assessment of the domino accident in chemical industry. *Process Safety and Environmental Protection* 144, 79-92.
- Hemmatian B., Abdolhamidzadeh B., Darbra R. M., Casal J., 2014. The significance of domino effect in chemical accidents. *Journal of Loss Prevention in the Process Industries* 29, 30-38.
- Huang K., Chen G., Khan F., Yang Y., 2021. Dynamic analysis for fire-induced domino effects in chemical process industries. *Process Safety and Environmental Protection* 148, 686-697.
- Janssens J., Talarico L., Reniers G., Sorensen K., 2015. A decision model to allocate protective safety barriers and mitigate domino effects. *Reliability Engineering and System Safety* 143, 44-52.
- Jensen K., Kristensen L. M., 2015. Colored Petri Nets: A Graphical Language for Formal Modeling and Validation of Concurrent Systems. *Communications of the ACM* 58, 61-70.
- Kadri F., Chatelet E., 2013. Domino Effect Analysis and Assessment of Industrial Sites: A Review of Methodologies and Software Tools. *International Journal of Computers and Distributed Systems* 2, 1-10.
- Kamil M.Z., Taleb-Berrouane M., Khan F., Ahmed S., 2019. Dynamic domino effect risk assessment using Petri-nets. *Process Safety and Environmental Protection* 124, 308-316.
- Khakzad N., 2015. Application of dynamic Bayesian network to risk analysis of domino effects in chemical infrastructures. *Reliability Engineering and System Safety* 138, 263-272.
- Khakzad N., Khan F., Amyotte P., Cozzani V., 2014. Risk Management of Domino Effects Considering Dynamic Consequence Analysis. *Risk Analysis* 34, 1128-1138.

- Khakzad N., Reniers G., 2017. Cost-effective allocation of safety measures in chemical plants w.r.t land-use planning. *Safety Science* 97, 2-9.
- Landucci G, Argenti F, Spadoni G, Cozzani V., 2016. Domino effect frequency assessment: The role of safety barriers. *Journal of Loss Prevention in the Process Industries* 44, 706-717.
- Landucci, G., Argenti, F., Tugnoli, A., Cozzani, V., 2015. Quantitative assessment of safety barrier performance in the prevention of domino scenarios triggered by fire. *Reliability Engineering and System Safety* 143, 30-43.
- Li Q., Deng Y., Liu C., Zeng Q., Lu Y., 2016. Modeling and analysis of subway fire emergency response: An empirical study. *Safety Science* 84, 171-180.
- Li W., He M., Sun Y., Cao Q., 2019. A novel layered fuzzy Petri nets modelling and reasoning method for process equipment failure risk assessment. *Journal of Loss Prevention in the Process Industries* 62, 103953.
- Luo X., Zhang Q., Jin Y., 2019. Actantial Narrative Schema in Emergency Response Process Modeling for Aircraft Fires. *Journal of Advanced Transportation* 2019, 6143027.
- Ministry of Housing and Urban-Rural Development of the People's Republic of China, 2019. Standart for fire prevention design of petrochemical enterprise (Edition 2018). China Planning Press, Beijing. ISBN: 9155182047303.
- Misuri A., Landucci G., Cozzani V., 2020. Assessment of safety barrier performance in the mitigation of domino scenarios caused by Natech events. *Reliability Engineering & System Safety* 205, 107278.
- Mudan K.S., 1984. Thermal radiation hazards from hydrocarbon pool fires. *Progress Energy Combustion Science* 10, 59-80.
- Necci A., Cozzani V., Spadoni G., Khan F., 2015. Assessment of domino effect: State of the art and research Needs. *Reliability Engineering and System Safety* 143, 3-18.
- Ovidi F., Zhang L., Landucci G., Reniers G., 2021. Agent-based model and simulation of mitigated domino scenarios in chemical tank farms. *Reliability Engineering and System Safety* 209, 107476.
- Peng C., 2010. The Statistics Law of Fire Response Time and its Correlation with the Scale of Urban Fire (Thesis for Master's Degree). University of Science and Technology of China.
- Ramalho A.H.C., da Silva E.F., Silva J.P.M., Fiedler N.C., Maffioletti F.D., Biazatti L.D., Moreira T.R., Juvanhol R.S., dos Santos A.R., 2021. Allocation of water reservoirs to fight forest fires according to the risk of occurrence. *Journal of Environmental Management* 296, 113122.

- Reniers G., Cozzani V., 2013. *Domino Effects in the Process Industries: Modeling, Prevention and Managing*. Elsevier, Amsterdam. ISBN: 978-0-444-54323-3
- Su Z., Zhang G., Liu Y., Yue F., Jiang J., 2016. Multiple emergency resource allocation for concurrent incidents in natural disasters. *International Journal of Disaster Risk Reduction* 17, 199-212.
- Sun H., Wang H., Yang M. Reniers G., 2021. Resilience-based approach to safety barrier performance assessment in process facilities. *Journal of Loss Prevention in the Process Industries* 73, 104599.
- Taleb-Berrouane M., Khan F., Amyotte P., 2020. Bayesian Stochastic Petri Nets (BSPN) - A new modelling tool for dynamic safety and reliability analysis. *Reliability Engineering & System Safety* 193, 106587.
- Wang H., Liu Y., Fang J., He J., Tian Y., Zhang H., 2020. Emergency sources pre-positioning for resilient restoration of distribution network. 7th International Conference on Power and Energy Systems Engineering (CPSE 2020), 26–29 September 2020, Fukuoka, Japan,
- Wu Z., Hou L., Wu S., Wu X., Liu F., 2020. The time-to-failure assessment of large crude oil storage tank exposed to pool fire. *Fire Safety Journal* 117, 103192.
- Yeboah G., Park P.Y., 2018. Using survival analysis to improve pre-emptive fire engine allocation for emergency response. *Fire Safety Journal* 97, 76-84.
- Zeng Q.T., Liu C., Duan H., 2016. Resource conflict detection and removal strategy for nondeterministic emergency response processes using Petri nets. *Enterprise Information Systems* 10, 729-750.
- Zeng T., Chen G., Yang Y., Chen P., Reniers G., 2020. Developing an advanced dynamic risk analysis method for fire-related domino effects. *Process Safety and Environmental Protection* 134, 149-160.
- Zhang M., Zheng F., Chen F., Pan W., Mo S., 2019. Propagation probability of domino effect based on analysis of accident chain in storage tank area. *Journal of Loss Prevention in the Process Industries* 62, 103962.
- Zhang X., Ding S., Ge B., Xia B., Pedrycz W., 2021. Resource allocation among multiple targets for a defender-attacker game with false targets consideration. *Reliability Engineering and System Safety* 211, 107617.
- Zhou J., Reniers G., 2016. Petri-net based simulation analysis for emergency response to multiple simultaneous large-scale fires. *Journal of Loss Prevention in the Process Industries* 40, 554-562.
- Zhou J., Reniers G., 2017. Analysis of emergency response actions for preventing fire-induced domino effects based on an approach of reversed fuzzy Petri-net. *Journal of Loss Prevention in the Process*

- Industries, Volume 47, 169-173.
- Zhou J., Reniers G., 2018. Petri-net based evaluation of emergency response actions for preventing domino effects triggered by fire. *Journal of Loss Prevention in the Process Industries* 51, 94-101.
- Zhou J., Reniers G., 2020. Probabilistic Petri-net addition enabling decision making depending on situational change: The case of emergency response to fuel tank farm fire. *Reliability Engineering & System Safety* 200, 106880.
- Zhou J., Reniers G., Cozzani V, 2021. Improved probit models to assess equipment failure caused by domino effect accounting for dynamic and synergistic effects of multiple fires. *Process Safety and Environmental Protection* 154, 306-314.
- Zhou S., Erdogan A., 2019. A spatial optimization model for resource allocation for wildfire suppression and resident evacuation. *Computers & Industrial Engineering* 138, 106101.
- Zuberek W.M., 1991. Timed Petri nets-Definitions, properties and applications. *Microelectronics Reliability* 31 (4), 627-644.