



ALMA MATER STUDIORUM  
UNIVERSITÀ DI BOLOGNA

## ARCHIVIO ISTITUZIONALE DELLA RICERCA

### Alma Mater Studiorum Università di Bologna Archivio istituzionale della ricerca

Reverse osmosis and nanofiltration opportunities to concentrate multicomponent mixtures of volatile fatty acids

This is the final peer-reviewed author's accepted manuscript (postprint) of the following publication:

*Published Version:*

Domingos J.M.B., Martinez G.A., Morselli E., Bandini S., Bertin L. (2022). Reverse osmosis and nanofiltration opportunities to concentrate multicomponent mixtures of volatile fatty acids. *SEPARATION AND PURIFICATION TECHNOLOGY*, 290, 1-10 [10.1016/j.seppur.2022.120840].

*Availability:*

This version is available at: <https://hdl.handle.net/11585/895273> since: 2024-07-30

*Published:*

DOI: <http://doi.org/10.1016/j.seppur.2022.120840>

*Terms of use:*

Some rights reserved. The terms and conditions for the reuse of this version of the manuscript are specified in the publishing policy. For all terms of use and more information see the publisher's website.

This item was downloaded from IRIS Università di Bologna (<https://cris.unibo.it/>).  
When citing, please refer to the published version.

(Article begins on next page)

**Reverse osmosis and nanofiltration opportunities to concentrate  
multicomponent mixtures of volatile fatty acids**

Joana M. B. Domingos, Gonzalo A. Martinez\*, Elena Morselli, Serena Bandini\*, Lorenzo Bertin

Department of Civil, Chemical, Environmental and Materials Engineering- DICAM  
Alma Mater Studiorum – University of Bologna – Via U. Terracini, 28, I-40131, Bologna, Italy

Gonzalo A. Martinez (\*corresponding author): [gonzalo.martinez3@unibo.it](mailto:gonzalo.martinez3@unibo.it)

Tel: (+39) 051 20 90314

Serena Bandini (\*corresponding author): [serena.bandini@unibo.it](mailto:serena.bandini@unibo.it)

Tel +39 051 2090231

## **ABSTRACT**

The application of reverse osmosis (RO) and nanofiltration (NF) to concentrate and/or fractionate volatile fatty acids (VFAs, occurring in acidogenic effluents) was systematically assessed for the first time using three commercial spiral wound modules. A bench scale plant was used to test the polyamide membrane cartridges, namely: AG1812-34D, DK1812-34D and NFS-3B-1812F. The effects of main operational parameters (pH, temperature, applied pressure) were firstly studied in total recirculation mode, using different total and relative VFA compositions. Thereafter, batch concentration tests were carried out (at constant applied pressure, ca. 30 bar) to fully characterize the RO and NF modules. AG1812-34D performed as an RO module and it allowed concentrating target solutions almost 3 times without relevant VFA losses (<4%) in the permeate side. All tested parameters were observed to affect concentration performances. However, typical pH levels occurring in acidogenic effluents allowed to achieve fully satisfactory VFA rejections. DK1812-34D and NFS-3B-1812F performed as NF modules and could represent suitable solutions for VFA fractionation. Separation factors significantly increased by pH rise; in particular, high acetic and propionic acid separation factors over butyric acid were achieved at pH 9, with DK1812-34D module.

*Key Words:* membrane separation; carboxylic acids; recovery; concentration; fractionation

## 1. INTRODUCTION

Coupling agro-industrial by-products and urban waste treatment with the manufacture of added value products represents the main driving force of circular economy. In this framework, the production of short and medium chain length carboxylic acids (from acetic to octanoic acids) by mixed culture acidogenic fermentation bioprocesses is of notice. Briefly, this economic and robust technology allows to hydrolyse complex molecules contained in biowaste and by-product matrixes and to produce such molecules, also called volatile fatty acids (VFAs). The industrial interest on VFAs resides on the many applications these molecules have, e.g. as food or antimicrobial additives as well as precursors for the production of alcohols, aldehydes, ketones, esters, olefins and PHAs [1–3].

However, despite its huge potential, the development of such a carboxylate platform has not been massively scaled up yet. The assigned main reason is the unavailability of an economically sustainable downstream process, which on average accounts for 30-40% of the final cost [4]. Specifically, main drawbacks are: final VFA titer is relatively low (ca. 30 g/L) [5], physicochemical features of the fermentation broths are complex [6] and VFA-sodium salts are highly soluble in water (e.g. 1200 g/L for sodium acetate). In this regard, several processes (aimed at VFA concentration, purification and recovery) have been intensively studied during the last years, namely: salting out, adsorption, ion-exchange, reactive distillation, stripping, solvent extraction, and membrane-based processes (among which, electrodialysis, pertraction, reverse osmosis and nanofiltration) [7–9]. The most appropriate operation depends on the final purpose, e.g. obtainment of single highly purified VFAs as fine chemicals or highly concentrated VFA-mixtures

not necessarily purified as substrate feeding solution for the production of polyhydroxyalkanoates [5,10].

Thus, in the general framework of downstream strategies dedicated to the exploitation of VFA-rich aqueous effluents, the present work aims to study the fractionation and concentration (dewatering) of VFAs contained in fermentation broths. Both aims are interesting in the perspective of obtaining VFA-concentrated streams with defined compositions to be used for feeding consecutive (bio)processes addressed to VFA conversion into valuable chemicals and biopolymers. In this concern, previous research based on ion-exchange and conventional electrodialysis processes allowed to conclude that these approaches are feasible option for concentrating target VFA solutions whereas they are not effective for VFA fractionation. In both operations, acid dissociation constants were observed as the parameters that would allow fractionation, and, notably, values related to single VFAs are very similar (pKa between 4.76-4.88) [5,11]. Besides, distillation, stripping, solvent extraction and salting out were not considered as winning industrial strategies since their intensive energy demand and/or by-products generation [8]. Therefore, nanofiltration (NF) and reverse osmosis (RO) were proposed since both processes have *i)* low energy demand, *ii)* combined mechanisms of separation (electrostatic repulsion and molecular size) and *iii)* no significant by-product generation. Indeed, NF and RO have been tested for separating carboxylic acids. However, many works were dedicated to VFA elimination from sugar-rich hydrolysates to render the fermentation substrate free from inhibitors [12,13]. Moreover, NF and RO were assessed for recovering lactic and succinic acids, but few investigations were focused on the recovery of VFAs [14–16]. As a whole, most of the studies reported membrane screening tests at different operating conditions (being salt strength,

pressure and pH target variables). However, dead-end filtration system, flat-sheet membrane arrangement and synthetic solutions with low VFA titer (0.5-5 g/L rather than the typical 20-40 g/L by acidogenic fermentation of agro-industrial by-products) were employed , or even the use of a single VFA synthetic solution[14,17]. Hence, there is still a need to analyse and evaluate the feasibility for VFA fractionation and concentration in NF and/or RO systems by taking into account further key process specifications, and in particular the large complexity of actual acidogenic effluents and configurations of processes carried out at fully industrial scale.

With all this in mind, the purpose of the work is to significantly improve the knowledge and the applicability of NF and RO processes for VFA concentration and fractionation by *i)* testing proper multicomponent solutions, *ii)* using spiral wound NF/RO modules typically exploited for process scale up and *iii)* designing and carrying out experiments under total recirculation and concentration (batch) modes. Different commercial RO and NF spiral wound membranes have been tested for the concentration and/or the fractionation of multicomponent aqueous solutions of VFAs. To this aim, laboratory prepared solutions were used to simulate the actual VFA-rich broths, containing VFA-sodium salts (8-20 g/L, from acetate to heptanoate) and phosphates. The role of pH, temperature and VFA mixture composition on the separation efficiency by commercial membranes was tested and widely documented by a systematic experimentation: apparent rejections as well as separation factors were determined for each acid by using a pilot plant operating in total recirculation and concentration modes in a wide range of final VFA concentration values. Finally, the best operative conditions required to concentrate and/or separate VFAs were discussed.

## 2. MATERIALS AND METHODS

### 2.1. Broth simulating solutions, membranes, and pilot plant

Two solutions, with different composition and total VFA concentrations, were used in the experiments; main features are shown in **Table 1**. Solution A simulated a typical VFA-rich broth like those obtained from the fermentation of grape pomace, fruits and vegetable waste or urban wastes [11]. Instead, solution B simulated the actual broth reported in the framework of the European project NoAW (to which this work belongs also), it was obtained by anaerobically fermenting a zootechnical-stream [18]. Solutions were prepared using distilled water (conductivity < 80  $\mu$ S) and pH was adjusted to 6 (in both solutions, by dropping a 10 M-NaOH) to simulate the conventional operating condition applied in anaerobic fermentation for obtaining high VFA concentrations [19]. For studying the role of the pH-level operating condition, NaOH (10 M) or HCl (12 M) was added to solution A already prepared at pH 6 until target pH-level was reached. All chemicals were purchased from Merk, while distilled and demineralised water were produced using a commercial equipment.

**Table 1:** Main features of the solutions

specie (abbreviation)	solutions	
	A (g/L)	B (g/L)
acetic acid (AA)	4.00	3.80
propionic acid (PA)	4.00	1.30
butyric acid (BA)	4.00	1.80
iso-butyric acid (i-BA)	--	0.08
valeric acid (VA)	4.00	0.58
iso-valeric acid (i-VA)	--	0.09
hexanoic acid (HA)	4.00	0.44
heptanoic acid (EA)	--	0.11
KH <sub>2</sub> PO <sub>4</sub>	1	0.43

Na <sup>+</sup>	3.82	2.35
pH	6	6
Total VFAs (VFAs <sub>Tot</sub> )	20.00	8.20

Three commercial spiral wound modules, with nominal size 1.8x12 inches (diameter x length) and TFC polyamide membranes, were tested: a brackish water RO cartridge (AG1812-34D) and two nanofiltration cartridges (DK1812-34D and NFS-3B-1812F). Geometrical details and nominal rejections are shown in **Table 2**.

**Table 2:** Spiral wound modules geometrical and performance characteristics  
Data from technical sheets [20,21]

Model and Abbreviation	AG1812-34D AG	DK1812-34D DK	NFS-3B-1812F NFS
Manufacturer	GE Power & Water (*)		Synder Filtration
NaCl retention @ conditions	99% @ 2g/L, 15.51 bar, 25 °C	--	50-55% @ 2g/L, 7.6 bar, 25 °C
MgSO <sub>4</sub> retention @ conditions	--	98% @ 2 g/L, 7.6 bar, 25 °C	99.5% @ 2 g/L, 7.6 bar, 25 °C
nominal area (m <sup>2</sup> )	0.38	0.38	0.28
feed spacer (mil)	34	34	46

(\*) at present, manufactured by Suez.

Experiments were carried out in the pilot plant described previously elsewhere [22] and reported in **Fig. 1** for clarity sake. It allowed to conduct experiments using *i*) total recirculation or *ii*) batch modes. The former configuration allowed to maintain constant chemical concentrations in the feed side throughout the experimentations, by constantly recycling the permeate and the retentate to the feed tank (S-1). Differently, the permeate stream was continuously discharged in



the batch mode, this allowing to carry out experiments in which the chemical concentrations of the feed stream increased with time.

All experiments were performed at a feed flow rate ( $Q_F$ ) of 400 L/h (typical for the used module configuration), under controlled temperature and pressure in the feed side. The permeate side was kept at atmospheric pressure. Hence, the applied transmembrane pressures are reported as the average ( $\Delta P_{Av}$ ) between the module inlet (manometer PI-2) and outlet (manometer PI-3), i.e.

$$\Delta P_{Av} = (P_2 + P_3)/2 - P_{atm}. [22]$$

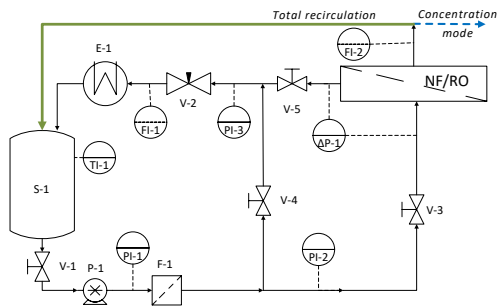

**Fig. 1:** Pilot plant units: feed tank (S-1) with a thermometer (TI-1), positive displacement pump (P-1), guard filter (F-1), regulating valves (V-1, V-3, V-4, V-5), needle valve (V-2), 1812 gasket and cartridge (NF/RO), manometers (PI-1, PI-2, PI-3), differential pressure gauge ( $\Delta P$ -1), flowmeters (FI-1, FI-2) and heat exchanger (E-1). The plant can be run in total recirculation ( $\rightarrow$ ) or concentration modes ( $---\rightarrow$ ).

## 2.2. Experimental approach

The conventional experimental procedure followed in the experiments was already described in details elsewhere [22,23]. The general approach applied during the entire work included the following steps: (1) modules were stored in 1% sodium bisulfite at room temperature; (2) they were conditioned and stabilized, before using, by flowing through demineralised water (14.7-15  $\mu\text{S}/\text{cm}$ ) and a consecutive basic/acid/water washing step; (3) characterised by measuring the hydraulic permeability ( $L_{pw}$ ) with demineralized water; (4) finally, after each set of experiments, modules were rinsed with demineralized water and the  $L_{pw}$  measurements were repeated to detect the presence of fouling; in case of fouling, the basic/acid washing procedure was repeated until satisfactory module regeneration. According to this approach, two types of experiments were performed, as follows.

#### 2.2.1. Operating parameter screening tests under total recirculation mode

Firstly, experiments were conducted in total recirculation mode in order to screen and assess the role of different operating parameters, namely: pH, temperature,  $\Delta P_{Av}$  as well as VFA relative and total concentrations. To this end, the pilot plant (shown in **Fig. 1**) was operated according to the following procedure: *i*) the feed tank S-1 was charged with 20L of solution A or B at defined pH, *ii*) the experimental temperature condition was established by means of the heat exchanger E-1, *iii*)  $\Delta P_{Av}$  was set to the specific experimental value using the needle valve V-2 together with the pump P-1 inverter to set  $Q_F$ , and *iv*) the system was let to stabilize. Permeate flow rates ( $Q_P$ ) were measured after 30, 35 and 40 min to check the achievement of steady state conditions; the recorded  $Q_P$  data are the mean of those values. During the last measurement, 2 ml samples were separately collected from feed and permeate streams for analyses concerning VFA concentrations

and pH. This procedure was repeated for all tested conditions reported in **Table 3** (Total recirculation mode).

### 2.2.2. Concentration tests under batch mode

Secondly, experiments were conducted in batch concentration mode at constant  $\Delta P_{Av}$  and  $Q_F$  (400 L/h). The assessed temperatures and pH conditions (**Table 3, Batch mode**) were selected as to make a comparison with the most interesting results observed in the total recirculation experiments. The start-up procedure was that one described in the previous subsection, but after step *iv* the recycling stream was taken out from the feed tank S-1 to start the batch concentration experiments. In these experiments, after periodical  $Q_P$  measurements, 2 ml samples were separately collected from feed and permeate flows for analyses concerning VFA concentrations and pH levels.

**Table 3:** Operating conditions of experiments conducted with VFA solutions in total recirculation and batch modes

<b>Total recirculation mode</b>				
module	T (°C)	pH	$\Delta P_{Av}$ (bar)	Solution
AG1812	30	4, 5, 6, 6.5, 7, 8	11-30	A
	45	6.5		
DK1812	30	4.8, 5, 6, 7, 8, 9	4-30	A
		6		B
NFS1812	30	5, 6, 6.5, 7, 8, 9	4-30	A
<b>batch mode</b>				
AG1812	30, 45	6.5	29.2	A
DK1812	30	7, 9	29.5, 29.2	

Single VFA concentrations were determined by GC-FID as reported elsewhere [24] while a conventional laboratory probe (XS POLYMER PLAST S7) was used for measuring the pH.

### 2.3. Parameter calculations

The following process parameters were determined and used for process evaluations:

- (a) Total volume flux ( $J_v$ ) and  $L_{pw}$  were calculated according to:

$$J_v = \frac{Q_p}{A_m} = L_{pw} \cdot \Delta P_{eff} \quad (1)$$

where  $A_m$  represents the module membrane area and  $\Delta P_{eff}$  the effective driving force. This last accounts for the contributions of the  $\Delta P_{Av}$  and the osmotic transmembrane pressure ( $\Delta\pi$ ) which should be calculated using the occurring concentrations at the membrane interfaces if concentration polarization occurs [22,25];

- (b) Observed or apparent rejections ( $R_{obs,n}$ ) of single or total VFAs ( $n$ ), which were calculated by considering the concentrations measured in the feed ( $C_{F,n}$ ) and in the permeate ( $C_{P,n}$ ) streams:

$$R_{Obs,n} = 1 - \frac{C_{P,n}}{C_{F,n}} = 1 - \frac{J_n}{(C_{F,n} * J_v)} \quad (2)$$

where  $J_n$  represents the solute flux;

- (c) Separation factor of a single acid ( $n$ ) with respect to butyric acid ( $BA$ ), calculated according to:

$$\alpha_{n/BA} = \frac{C_{P,n}/C_{P,BA}}{C_{F,n}/C_{F,BA}} = \frac{1-R_{Obs,n}}{1-R_{Obs,BA}} \quad (3)$$

where the  $n$  to  $BA$  concentration ratio in the permeate is compared with the corresponding ratio in the feed;

- (d) purity (wt%) of an acid ( $n$ ) in the permeate or retentate streams, which was calculated as its concentration ratio with respect to that of the total VFAs ( $VFAs_{Tot}$ ):

$$Pur_n = \frac{C_n}{VFAs_{Tot}} \quad (4);$$

(e) Cumulative percentage mass loss of total VFAs through the permeate stream at any time  $t$  of the batch experiments, calculated as:

$$VFA \text{ loss in } P (t) = \frac{\int_0^t J_v(t).VFAS_{Tot}(t).A_m.dt}{m_{Tot VFAs}(0)} \quad (5)$$

where  $m_{Tot VFAs}(0)$  represents the initial total mass of VFAs in the feed stream.

### 3. RESULTS AND DISCUSSION

Main obtained results are reported and discussed in three principal sections. The first one shows the module characterisations and evidences that experimental results were not affected by membrane significant fouling. The second and third sections present and discuss the results of the total recirculation and batch concentration experiments, respectively.

#### 3.1. Membrane characterization and fouling detection between tests

The hydraulic permeability measurements at different times allowed to compare the actual  $L_{pw}$  with the nominal values and so to detect potential fouling effects due to the membrane use. The role of pH on  $L_{pw}$  was not investigated since it was demonstrated negligible in previous studies [26]; all measurement were carried out at the deionised water pH of 5.6. Average  $L_{pw}$  values (considering nominals and before/after use measurements) along with related standard deviations are reported in **Table 4**. The irrelevant standard deviations (<10%) indicate that permanent fouling effects were negligible in all the experiments. Thus, results reported in next sections can be considered unaffected by detectable fouling. Moreover, the obtained  $L_{pw}$  in modules AG and DK showed results greatly in agreement with data previously reported [22,23].

No previous reports were found for the membrane NFS, whose measured  $L_{pw}$  values were in-between those of AG and DK; this clearly documents that NFS is a low permeability NF membrane.

**Table 4:** Spiral wound modules hydraulic permeabilities ( $L_{pw}$ , in L/( $\text{hm}^2\text{bar}$ )  $\zeta$

	27 °C	30°C	40°C	45°C	50°C
AG	--	$1.59_{+0.16}^{-0.07}$ (8)	$2.42_{+0.14}^{-0.25}$ (3)	$2.83_{+0.07}^{-0.06}$ (6)	--
DK	7.52 (1)	$8.27_{+0.31}^{-0.37}$ (11)	--	--	12.05 (2)
NFS	--	$4.59_{+0.33}^{-0.26}$ (11)	--	6.76 (1)	

( $\zeta$ ) the number of trials along experimentation is reported in brackets.

All that preliminary evidence stated, the following sections were focused on main results concerning the screening of the target operational parameters and on deepening module characterization by means of batch concentration tests.

### 3.2. Operational parameter screening tests under total recirculation mode

The effect of main operational parameters ( $\Delta P_{Av}$ , pH, temperature and composition) on membranes performances is here reported and discussed in the perspective of developing VFA fractionation and/or concentration processes.

#### 3.2.1 pH and $\Delta P_{Av}$ effects

**Fig. 2** and **Fig. 3** show the obtained  $R_{obs}$  vs  $J_v$  profiles for single acids when the modules AG and DK were operated at different pH-levels, respectively. Complete screening results for NFS are shown in **Fig. S1** in Supplementary material. Since  $J_v$  is directly proportional to  $\Delta P_{Av}$ , the figures

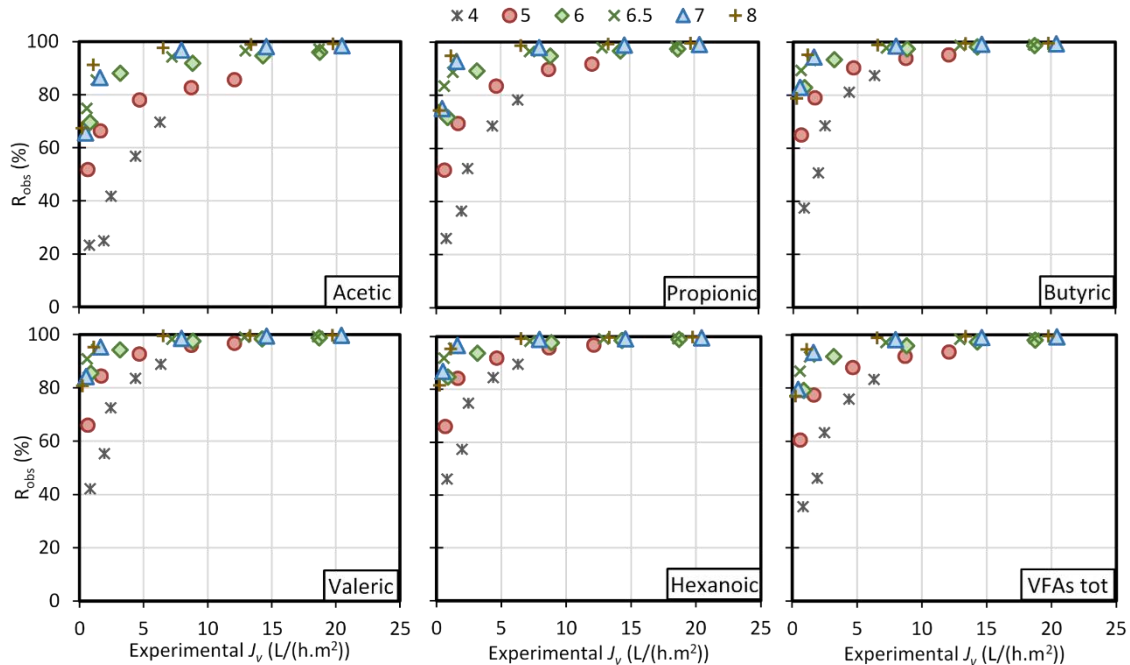

**Fig. 2:** Filtration of solution A at 30 °C with AG module. Experimental observed rejection ( $R_{obs}$ ) for acetic, propionic, butyric, valeric, hexanoic or total acids (VFAs tot) at different pH levels and  $\Delta P_{Av}$  (resulting in different  $J_v$ ).

report the effect of both target parameters ( $J_v$  or  $\Delta P_{Av}$ ) on  $R_{obs}$  of single acids. For all membranes, rejections were observed to increase with  $\Delta P_{Av}$  rise until achieving asymptotes. These typical  $R_{obs}$  vs  $J_v$  trends were already described by many models (e.g. Spiegler-Kedem), and it can be analysed when considering equation 2 (in terms of  $J_v$  and  $J_n$ ), namely: *I*) higher  $\Delta P_{Av}$  increases the convection of solute ( $J_v \cdot C_{F,n}$ ), but membrane selectivity results in minor rise of solute fluxes ( $J_n$ ), making  $R_{obs}$  to increase; *II*) solute concentration on the membrane increase since the contemporary intensified counter-diffusion (from the membrane to the feed bulk) has minor transport significance due to the laminar flow on the membrane boundary layer; *III*) the  $R_{obs}$  achieves an asymptotic maximum when the concentration gradient across the membrane and  $\Delta P_{Av}$  start to be high enough that solute flux ( $J_n$ ) starts to increase almost at the same rate as

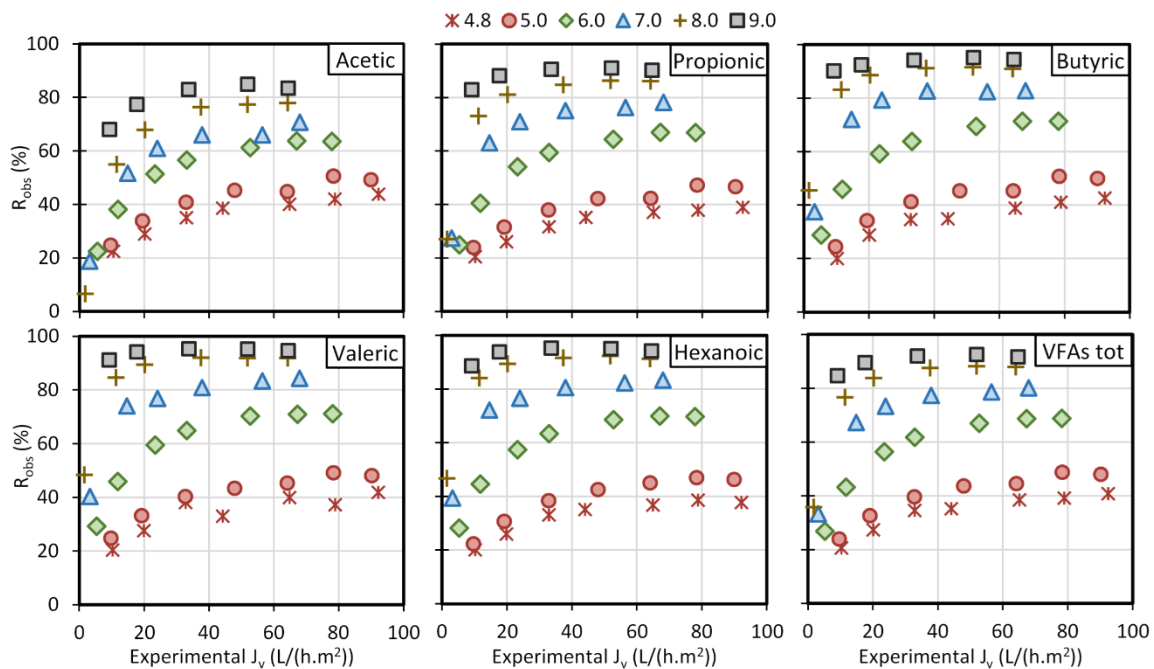

**Fig. 3:** Filtration of solution A at 30 °C with DK module. Experimental observed rejection ( $R_{obs}$ ) for acetic, propionic, butyric, valeric, hexanoic or total acids (VFAs tot) at different pH levels and  $\Delta P_{Av}$  (resulting in different  $J_v$ ).

$J_v \cdot C_{F,n}$ . In fact, the AG module (with higher selectivity -lower  $J_n$  values- due to the smaller pores) approached asymptotic rejections of 100% and vanish the pH effect. Importantly, despite the solute concentration gradient on the feed side, all tested conditions resulted to be done on pressure controlled and not in mass-controlled states (i.e. solute concentration on the membrane surface was not critical) as it can be observed from the linearity of the  $J_v$  vs  $\Delta P_{Av}$  trends (Fig. S2) and from the asymptotic shapes of  $R_{obs}$  curves (otherwise they should present concave shape). In agreement with behaviours previously reported by other authors [17,27,28], pH level and sieve effects were also observed with a systematic reproducibility of the general trend. Indeed, all membranes showed rejection increases when the pH level was raised, i.e.: the higher organic acids dissociation degrees the greater concentration of deprotonated organic acid (negatively



charged) which in turn are more rejected by the membrane owing to electrostatic interactions. In fact, the TFC membranes have a selective layer formed by a polyamide film supported on a polysulfone layer, which typically acquires a negative surface charge at pH levels greater than 4 [29–31]. Regarding the sieving effect, all membranes presented greater rejections for organic acids with higher molecular size despite all VFAs were almost equally dissociated under each tested pH condition ( $pK_a$  range of the single acids is 4.75-4.89). The effect is more significant at very low  $J_v$  and at higher pH levels for the NF membranes, e.g.: *i*) module AG at pH level of 6 and  $J_v$  of 1 L/hm<sup>2</sup> had 54% and 85% rejections for acetic and hexanoic acids while their asymptotic rejections resulted 96% and 100%, both respectively (**Fig. 2**); *ii*) module DK at pH 7 and  $J_v$  of 3 L/hm<sup>2</sup> had 19% and 40% rejections for acetic and hexanoic acids while their asymptotic rejections resulted 71% and 83%, both respectively (**Fig. 3**). Together with rejection increase, higher pH conditions also diminish the fluxes, as it can be observed in **Fig. 3** for the DK. Such effect was also seen for NFS module and reproduced to a minor extent in the case of the AG membrane (**Fig. 2**). This evidence was assigned to the additional osmotic pressure in solution A due to NaOH or HCl added, thus affecting  $\Delta\pi$  and therefore also the  $\Delta P_{eff}$  (equation 1). An overall view of the pH effect on total fluxes can be observed also in **Fig. S2** of the Supplementary Material, which compares the plots of all the experimental  $J_v$  vs  $\Delta P_{Av}$  at all the pH conditions investigated and explains the observed exceptions for AG at pH levels of 4 and 5.

The comparison of RO and NF tested modules is shown in **Fig. 4**, which reports  $R_{Obs}$  vs  $J_v$  trends for acetic acid and total VFAs obtained in the tests carried out at a pH level of 7 (i.e. a typical condition for actual VFA-rich effluents). It is evident that AG behaves as a RO membrane with a very high selectivity at the expense of very low fluxes (<20 L/(h.m<sup>2</sup>)), whereas the NF membranes

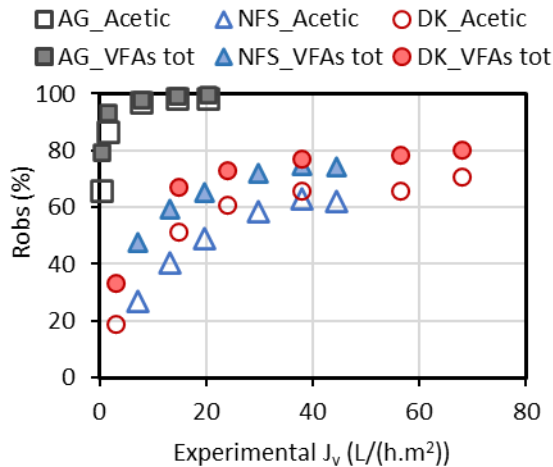

**Fig. 4:** Comparison of acetic ac. and total VFA rejections when filtrating solution A in total recirculation mode with the three membranes (pH 7 and 30 °C).

showed remarkably lower  $R_{Obs}$  but more than three times higher fluxes (up to 70 L/(h.m<sup>2</sup>)). In agreement with the permeabilities reported in **Table 4**, the NFS module had lower fluxes than DK, but contrary to what expected it had also slightly lower rejections. From all this, the RO AG module could be applied for concentration purposes and contemporary water recovery (e.g. to be recycling for agro-industrial matrix dilutions) at relatively low-pressure operating conditions. Conversely, the high fluxes and sieving effects of NF membranes could be exploited in a fractionation step, e.g. to enrich the permeate stream with the lower molecular weight acids such as acetic and propionic.

To support this idea, the separation factors of each acid with respect to butyric acid were calculated according to Eq. 3 for the experimental data obtained with the DK membrane; results are reported in **Fig. 5**. Interestingly, preferential permeation of AA and PA occurred with respect to BA, VA and HA at pH levels greater than 6. Indeed, separation factors higher than 1.5-2 and

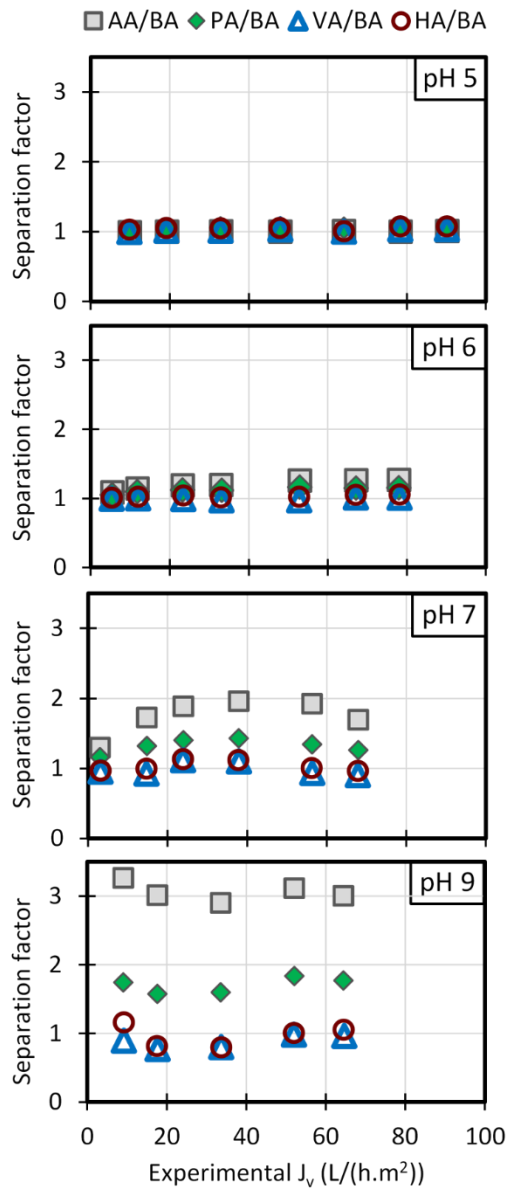

**Fig. 5:** Separation factors obtained during filtration in total recirculation with solution A at 30 °C and the module DK.

close to 3 were obtained for acetic (AA/BA) and propionic (PA/BA) acids at pH levels of 7 and 9, respectively. These values are comparable with those reported by Maiti et al.[28] for the separation of acetic acid over much higher molecular weight molecules, such as glucose (180 Da)

and xylose (150 Da), using the polyamide membrane Permeonics or the polyethylene sulfonate membrane NovaSep. Similar separation factors were obtained with the NFS module at the same pH levels (**Fig. S3** in Supplementary material). Conversely, no preferential permeation occurred at pH level  $\leq 5$  (i.e. separation factor kept close to one) and only a permeate with the original relative composition was obtained. From all this, the fractionation opportunities are further explored and discussed in **Section 3.3**, which focuses on the results obtained in batch concentration mode.

### 3.2.2 Concentration effects

The influences of total and relative VFA amounts were studied by comparing the observed rejections trends ( $R_{obs}$  vs  $J_v$ ) obtained with solutions A and B at the same operating conditions using module DK. The comparison is reported in **Fig. 6** for the acetic acid and total VFA rejection

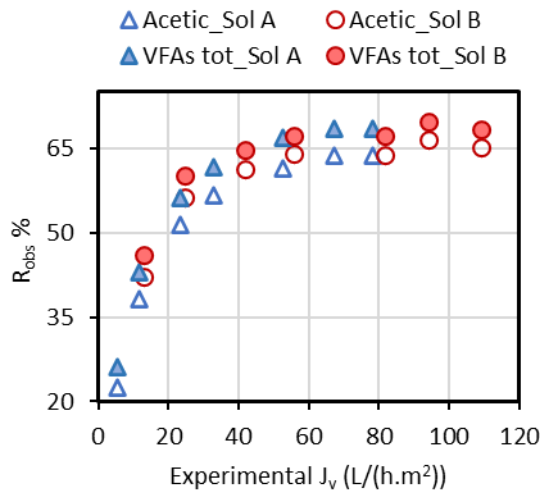
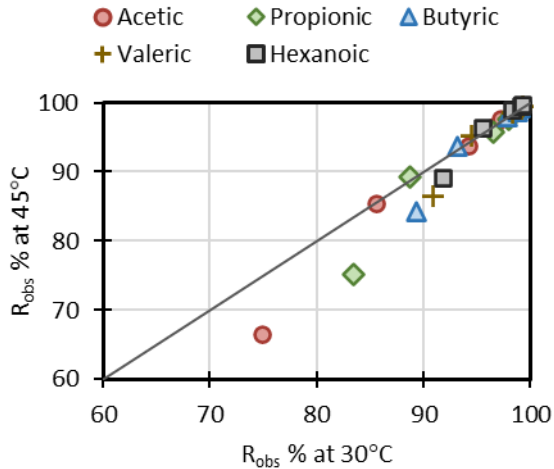

**Fig. 6:** Effects of relative and total VFA composition on the observed rejections ( $R_{obs}$ ) of AA and total VFAs for filtrations carried out with DK using solutions A and B at pH 6 and 30 °C.

trends. Neither the relative composition nor the total VFAs concentration significantly affected the observed rejections, as evidenced by the sharp overlapping of the curves. Identical overlapping trends were obtained for the other acids, as shown in **Fig. S5** of the Supplementary material. Furthermore, **Fig. 6** also points out a typical effect of feeding solution concentration on total flux: under the same  $\Delta P_{Av}$  conditions, the fluxes related to solution A (20 g/L) were 27-34% lower than those obtained when using solution B (8 g/L); also observed when plotting  $J_v$  vs  $\Delta P_{Av}$  data (**Fig. S6**). Finally, despite the mentioned trends do not suggest its occurrence, the role of concentration polarization should be investigated in a future work assessing the intrinsic membrane performances.

### 3.2.3 Temperature effects

Higher temperature conditions could allow  $J_v$  increment at comparable rejections without increasing VFA losses. This feature is of interest in the perspective of working under concentration (batch) mode. This opportunity was assessed with the AG membrane by performing an additional experimental set at 45 °C, under pH and  $\Delta P_{Av}$  conditions already tested at 30 °C (i.e. at pH 6.5 which is the typical acidogenic effluent's condition and 11-30 bar). The obtained results were encouraging since the higher temperature allowed increasing  $J_v$  by 45% (**Fig. S7** Supplementary material) while comparable  $R_{obs}$  were observed at both tested temperature values (**Fig. 7**). Slight deviations from parity (<15%) were detected only at the lowest  $\Delta P_{Av}$  tested condition, at which the relation between  $\Delta P_{Av}$  and  $J_v$  deviated from linearity (**Fig. S7** Supplementary material). Herein, temperature affected rejection performances even less than what reported previously elsewhere for the separation of acetic acid from monosaccharide using RO membranes [32]. This was



**Fig. 7:** Effect of temperature on single acids observed rejections ( $R_{obs}$ ). Comparison between filtrations carried out with AG at pH 6.5 using solution A at 30 and 45 °C. Each point corresponds to a certain operating  $\Delta P_{Av}$ .

ascribed to the fact that molecular size exclusion and electrostatic repulsion effects resulted more significant than the change of polymer structure in the active layer and/or pores expansion due to a higher operating temperature. Even more when considering that: *i*) the AG membrane has a smaller molecular weight cut-off than the RO98pHt (which has higher  $L_{pw}$ ) employed on reference [32] and *ii*) the experiments were carried out at a higher pH level ( $pH = 6.5 \approx pK_a + 2$ ), i.e. much more significative electrostatic repulsion condition.

### 3.3. Concentration tests under batch mode

According to the previously presented results for the tests carried out in total recirculation mode, batch experiments were conducted with AG and DK membranes with the main purpose of

investigating the role of concentration on membrane performances, in order to obtain suitable data for process scale-up.

First tests were carried out using the module AG at two different temperature conditions, i.e. 30 and 45°C, under the same conditions applied previously in total recirculation (30 bar and pH level of 6.5). Notably, AG allowed to concentrate solution A from 20 to 55 g/L at both tested temperatures (**Fig. 8 A**); thus, the concentration factor (of ca. 2.8 in both tests) was not affected by such parameter. As expected, fluxes diminished along the experiments in both conditions since higher VFA concentrations in the feed led to higher osmotic pressure effects ( $\Delta\pi$ ) and, thus, induced lower transmembrane effective pressures ( $\Delta P_{eff}$ ). Therefore, higher concentrations could be obtained with a pilot plant allowing to operate at higher  $\Delta P_{Av}$ . Remarkably, ca. 2 times higher fluxes were obtained for the condition carried out at 45 °C, owing to a higher membrane permeability (**Table 4**), but such advantage vanished when the concentration in the feed stream reached 43 g/L, i.e. when the osmotic pressure effect ( $\Delta\pi$ ) started to be as significant as to make the effective transmembrane pressure ( $\Delta P_{eff}$ ) near to zero. In analogy to what previously explained in Section 3.2.1, a decrease of the  $\Delta P_{eff}$  makes the solute convection ( $C_{F,n} * J_v$ ) to diminish more than the solute flux ( $J_n$ ) since the concentration gradient across the membrane is still high (diffusion to the permeate is significant) and, thus,  $R_{obs}$  decreases (equation 2). Indeed, **Fig. 8 B** shows that total VFA concentrations in the permeate were rather low and increased at a low rate until the concentration in the feed stream was ca. 40 g/L; from thereon, both curves increased from 1-1.4 g/L to 8.1-8.3 g/L at a rate more than 20 times higher than before. At the end of the concentration experiments, VFA mass losses through the permeate resulted lower than 4 and 3% for the batch tests carried out at 45 and 30 °C, respectively (**Fig. S9** in the Supplementary

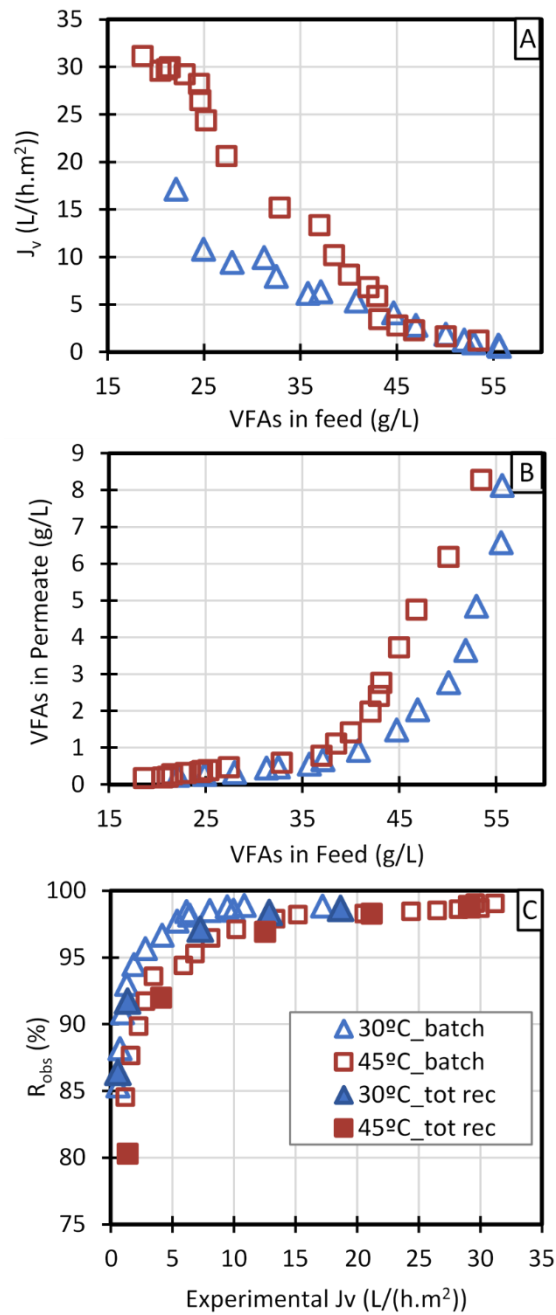

**Fig. 8:** Batch tests (pH 6.5) for concentrating solution A with AG at 30 and 45 °C. Responds of  $J_v$  and VFA mass losses with respect to concentration in the feed (Fig. A and B). Comparison of the  $R_{obs}$  vs  $J_v$  trends obtained in batch filtrations with those obtained in total recirculation mode (Fig. C).

Material). Such minor mass losses confirmed that AG is not useful for fractionation, i.e.: although



the acetic acid relative concentration resulted higher in the permeate stream, few mass permeated and, thus, its relative concentration in the retentate stream resulted constant all along the batch experiment (**Fig. S8** in the Supplementary Material).

Furthermore, as compared in **Fig. 8 C**, the observed rejections for single and total VFAs were highly similar to those obtained in total recirculation mode at same temperatures (**Section 3.2.3**).

The slight deviations at  $J_v < 10 \text{ L/hm}^2$  corresponded to conditions at which the concentration in the feed side were  $> 40 \text{ g/L}$  and where the  $\Delta P_{eff}$  resulted very low. Such deviations were previously observed in the total recirculation test carried out at  $45^\circ\text{C}$  (**Section 3.2.3**) for the experimental lowest pressure condition, in which  $\Delta P_{Av}$  vs  $J_v$  deviated from linearity. Moreover, the overlapped curves also put in evidence that total VFA concentration did not significantly affected  $R_{Obs}$ , neither at  $30^\circ\text{C}$  nor at  $45^\circ\text{C}$ .

Overall, the brackish RO membrane AG can be considered as suitable for concentrating VFAs-rich broths up to  $45 \text{ g/L}$ , with the contemporary recovery of rather pure water at  $J_v$  ranging from 30 to  $5 \text{ L/hm}^2$  (considered acceptable for industrial application). The recovered water could be recycled to the fermentation step, e.g. for limiting the use of fresh water when diluting or suspending the agro-industrial by-products to be fermented. The possibility to operate RO at higher pressures should be also explored since higher rejections and higher concentration factors are reasonably expected by increasing pressure. However, since maximum operating pressures of brackish water membranes are typically close to 40 bar, it is reasonable to expect that the maximum VFAs concentration achievable in a RO process might be close to  $60 \text{ g/L}$  in correspondence with still acceptable fluxes for an industrial process.

Notably, since the AG membrane performances are not affected by the total VFA concentration, concentration mode experiments are not crucial for process development and scale up purposes. Instead, experiments in total recirculation mode (easier and simpler) are recommended as sufficient and useful to characterize the membrane performances, provided that feed concentration is representative of typical acidogenic effluents (e.g. 20 g/L of total VFAs) and that a suitable pressure range is selected to allow determining a complete  $R_{Obs}$  vs.  $J_V$  curve (i.e. ranging from very low fluxes to asymptotic conditions).

On the other hand, DK membrane was tested at pH levels 7 and 9 (30 °C and 30 bar) since interesting separation factors were obtained in the previous experiments. The NF module allowed to concentrate VFAs from 20 to 63-67 g/L at both tested pH levels (**Fig. 9 A**), corresponding to a concentration factor higher than 3. Although the higher concentration achieved with DK at superior  $J_V$  (more performant than AG), greater losses of VFAs through the permeate were detected with the NF membrane as shown in **Fig. 9 B**. At the end of the concentration experiment, such VFA leakages represented ca. 50 and 30% of VFAs mass loss for the pH conditions 7 and 9, respectively (**Fig. S10** of the Supplementary Material).

Regarding the pH level effects, the batch results shown in **Fig. 9C** indicate that the higher the pH condition the lower the  $J_V$  and the greater the  $R_{Obs}$ , this reconfirms the outcomes of the total recirculation experiments (**Fig. 3** in Section 3.2.1). Furthermore, as compared in **Fig. 9C**, the observed asymptotic rejections for total VFAs were highly similar to those obtained in total recirculation mode at same pH levels (Section 3.2.1). However, the  $R_{Obs}$  vs.  $J_V$  resulted significantly lower than those obtained in total recirculation mode when total VFA concentration in the

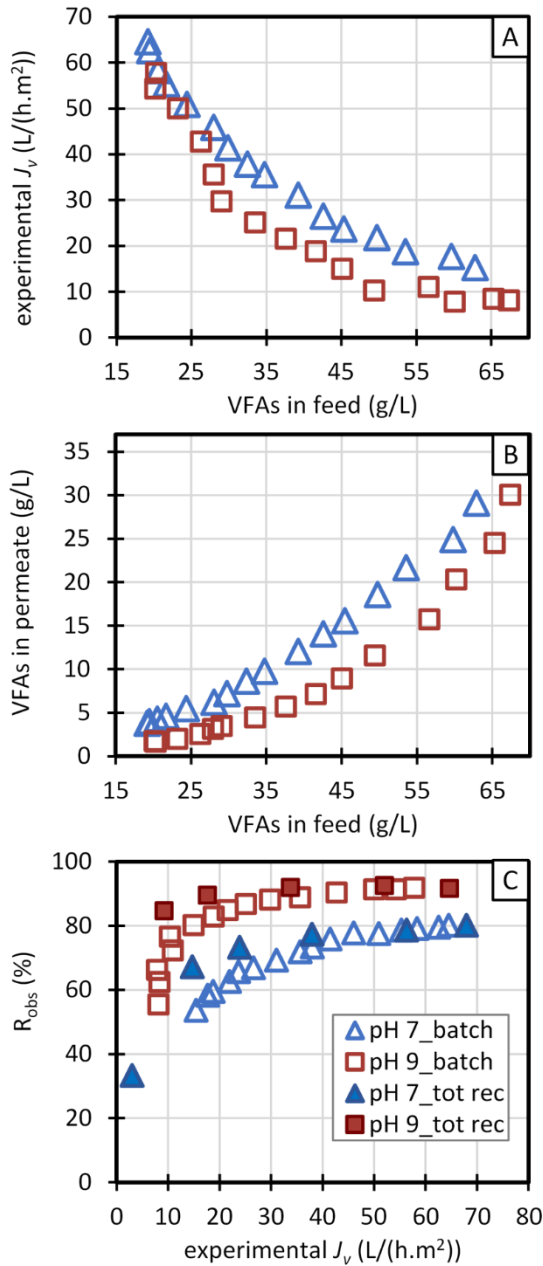
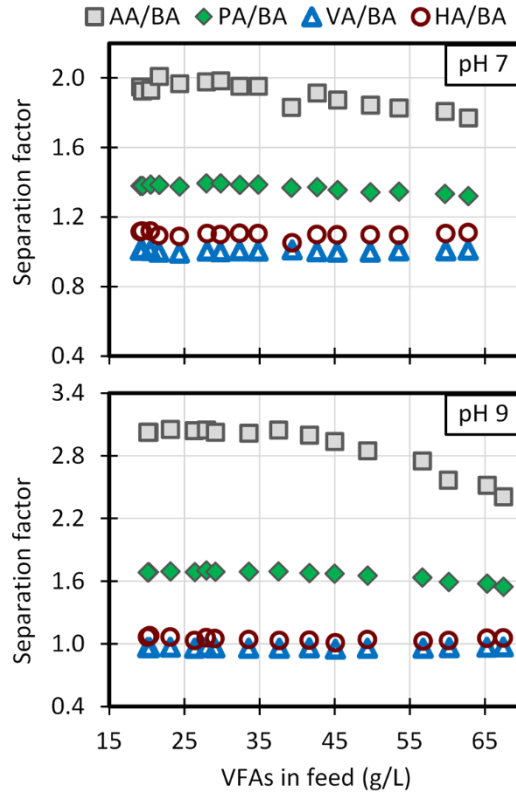

**Fig. 9:** Batch tests (at 30 °C) for concentrating the solution A with DK at pH 7 and 9. Responds of  $J_v$  and total VFA mass lost with respect to VFA concentration in the feed (Fig. A and B). Comparison of the  $R_{obs}$  vs  $J_v$  trends obtained in batch filtrations with those obtained in total recirculation mode (Fig. C).

retentate was  $\geq 30$ -35 g/L. Single or total VFA concentration effects were discarded as hypothesis

since it was not noticed in the experiments carried out in total recirculation (Section 3.2.2). Instead, it was again ascribed to the osmotic pressure which started to be significant: the decrease of  $\Delta P_{eff}$  diminished the  $J_v$  ( $< 20 \text{ L/hm}^2$ ) and, thus, the solute flux to solute convection ratio ( $J_n/C_{F,n} * J_v$ ) became higher which resulted in lower  $R_{obs}$  (equation 2). Indeed, the same abrupt declines were observed in the experiments carried out in total recirculation modes when: *i*) the DK module was operated at a pH level of 8 and  $J_v$  of  $2 \text{ L/hm}^2$  (**Fig. 3**), i.e. the  $R_{Obs}$  for acetic and propionic acids resulted at the equal or even lower to the values obtained at pH 5; *ii*) the AG was operated at  $45 \text{ }^\circ\text{C}$  and  $J_v$  of  $1.43 \text{ L/hm}^2$  (**Fig. 7**); both cases corresponding to experimental pressures condition in which  $\Delta P_{Av}$  vs  $J_v$  deviated from linearity (**Fig. S2 and Fig. S7** in the Supplementary Material). In order to better understand which effect finally determines the  $R_{Obs}$  curves, also the impact of concentration polarization should be evaluated and the intrinsic performances of the membranes should be assessed. Such study, which result beyond the purpose of this work, could be carried out in a future work.

Importantly, the diminish of  $R_{Obs}$  at high total VFA concentration obviously affected the fractionation, as evidenced by the resulting separation factors shown in **Fig. 10**. Notwithstanding this, and differently to what observed in the AG concentration experiments, the permeate high VFA concentrations obtained with DK did allowed fractionation. This is evidenced from the permeate and retentate purity plots shown in **Fig. 11** for the acetic acid, i.e. its purity is always greater in the permeate than in the retentate. Moreover, the initial retentate purity (Eq. 4) was 20% and it reached values lower than 15% at the end of the experiments, this meaning that acetic acid  $R_{Obs}$  diminished along the experiment. However, contrary to what expected from the acetic acid  $R_{Obs}$  decline, its purity in the permeate also diminished contemporaneously; this evidenced



**Fig. 10:** Separation factor of VFAs with respect to butyric acid along the batch concentration of solution A with DK module (30 °C) at the pH levels of 7 and 9.

that also the  $R_{Obs}$  of the other acids diminished. In turn, this reinforces the hypothesis of the low  $\Delta P_{eff}$  as the main cause of  $R_{Obs}$  decrease, i.e.: low  $J_v$  occurred due to  $\Delta\pi$  increase, consequently a small penetrated volume ( $J_v$  of 3.8 L/h) made the instant permeate concentration ( $C_{p,n}$ ) to increase at a higher rate than in the retentate ( $C_{F,n}$ ) which had a bigger volume of liquid (7 L recycling at a fast flow) and as a consequence all  $R_{Obs}$  decrease. Indeed, purity in the permeate decreased at a higher rate than in the retentate as shown in **Fig. 11**.

In the perspective of a process development, the DK membrane could be used for fractionation purposes by operating at pH level 7 (i.e. conventional pH level in acidogenic fermentations) and

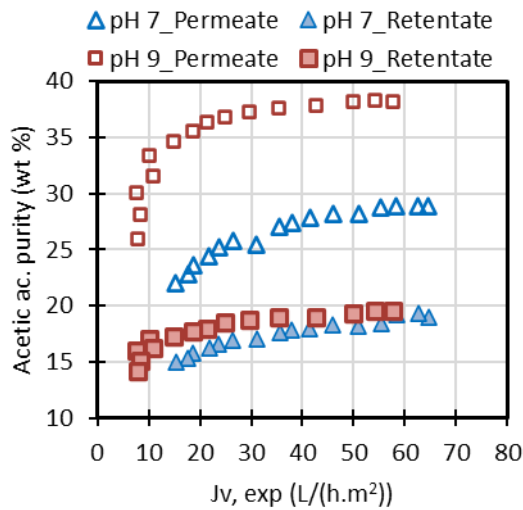

**Fig. 11:** Acetic acid purity evolution trends (in the permeate and retentate) during batch filtrations of solution A (30°C) at pH level of 7 and 9.

low concentrations (<40 g/L of total VFAs). A similar approach was previously reported elsewhere for the separation of butyric acid from glucose by employing the DuraSlick and HL NF membranes from Suez [33]. However, the present work demonstrated the feasibility of fractionating molecules whose chemical structure and features are much more similar to each other, i.e. the separation of acetic and propionic acid from butyric, valeric and hexanoic acids. Furthermore, the implementation of DK in a concentration step should be evaluated from an economical point of view in order to properly contrast the advantageous high  $J_v$  with the undesired mass loss. Indeed, a proper scheme could include the application of multiple modules in cascade; even the combination of NF and RO modules could result effective and with minor mass loss.

#### 4. CONCLUSIONS

The application of NF and RO membranes for concentrating and fractionating VFAs was systematically assessed at different operating conditions by using pilot scale spiral wound modules (more representatives). Results evidenced that RO brackish water membrane AG could be applied for VFA concentration (at least until 45 g/L) in a simple and economic process carried out at the typical pH level occurring in acidogenic effluents (from 6 to 7). Contemporary recovery of water is feasible, with minor VFA mass losses through the permeate. Besides pressure also the temperature was evidenced as an important parameter (i.e. for increasing fluxes during the dewatering step), while pH level showed minor effects (needs just to be  $\geq 5$ ). The results achieved with the NF membranes (NFS and DK) confirmed the feasibility to fractionate VFAs by using for the first time proper pilot membrane modules. Even a concentration step could be carried out with these NF membranes (achieving 65 g/L at 30 bar), but a process scheme must be developed in order to avoid VFA mass losses (ca. 50%) through the permeate. Apart from the pH relevance, total VFA concentration resulted important in NF membranes, probably evidencing concentration polarization effects. Thus, the determination of the membrane intrinsic rejections becomes crucial to obtain a clear characterization of the membrane performances, regardless of the module configuration or treated solution. Simulations using this data would allow to find the technoeconomic optimal scheme, useful for the process scale-up.

#### **CRedit author statement**

**Joana M. B. Domingos:** Investigation, Resources, Data Curation, Validation, Visualization, Writing-Original Draft

**Gonzalo A. Martinez:** Conceptualization, Methodology, Validation, Formal analysis, Visualization, Writing-Original Draft

**Elena Morselli:** Investigation

**Serena Bandini:** Conceptualization, Methodology, Visualization, Writing-Review & Editing.

**Lorenzo Bertin:** Writing-Review & Editing, Supervision, Project administration, Funding acquisition

### **Declaration of Competing Interest**

The authors declare that they have no known competing financial interests or personal relationships that could have appeared to influence the work reported in this paper.

### **ACKNOWLEDGMENTS**

The research received financial support by EU Horizon 2020 research and innovation program, project NoAw (“*No Agricultural Waste*”) under the Grant Agreement No 688338.

### **REFERENCES**

- [1] L.M.J. Sprakel, B. Schuur, Solvent developments for liquid-liquid extraction of carboxylic acids in perspective, *Sep. Purif. Technol.* 211 (2019) 935–957. doi:<https://doi.org/10.1016/j.seppur.2018.10.023>.
- [2] J.M.B. Domingos, G.A. Martinez, A. Scoma, S. Fraraccio, F.-M. Kerckhof, N. Boon, M.A.M. Reis, F. Fava, L. Bertin, Effect of operational parameters in the continuous anaerobic fermentation of cheese whey on titers, yields, productivities and microbial community structure, *ACS Sustain. Chem. Eng.* 5 (2016) 1400–1407. doi:[10.1021/acssuschemeng.6b01901](https://doi.org/10.1021/acssuschemeng.6b01901).
- [3] H.M. Ijmker, M. Gramblička, S.R.A. Kersten, A.G.J. van der Ham, B. Schuur, Acetic acid extraction from aqueous solutions using fatty acids, *Sep. Purif. Technol.* 125 (2014) 256–263. doi:<https://doi.org/10.1016/j.seppur.2014.01.050>.
- [4] A.J.J. Straathof, 2.57 - The Proportion of Downstream Costs in Fermentative Production Processes, in: M.B.T.-C.B. (Second E. Moo-Young (Ed.), Academic Press, Burlington, 2011: pp. 811–814. doi:<https://doi.org/10.1016/B978-0-08-088504-9.00492-X>.
- [5] J.M.B. Domingos, S. Puccio, G.A. Martinez, N. Amaral, M.A.M. Reis, S. Bandini, F. Fava, L.



- Bertin, Cheese whey integrated valorisation: Production, concentration and exploitation of carboxylic acids for the production of polyhydroxyalkanoates by a fed-batch culture, *Chem. Eng. J.* 336 (2018) 47–53. doi:<https://doi.org/10.1016/j.cej.2017.11.024>.
- [6] M.-P. Zacharof, R.W. Lovitt, Recovery of volatile fatty acids (VFA) from complex waste effluents using membranes, *Water Sci. Technol.* 69 (2013) 495–503. doi:10.2166/wst.2013.717.
- [7] A. Gössi, F. Burgener, D. Kohler, A. Urso, B.A. Kolvenbach, W. Riedl, B. Schuur, In-situ recovery of carboxylic acids from fermentation broths through membrane supported reactive extraction using membrane modules with improved stability, *Sep. Purif. Technol.* 241 (2020) 116694. doi:<https://doi.org/10.1016/j.seppur.2020.116694>.
- [8] S. Aghapour Aktij, A. Zirehpour, A. Mollahosseini, M.J. Taherzadeh, A. Tiraferri, A. Rahimpour, Feasibility of membrane processes for the recovery and purification of bio-based volatile fatty acids: A comprehensive review, *J. Ind. Eng. Chem.* 81 (2020) 24–40. doi:<https://doi.org/10.1016/j.jiec.2019.09.009>.
- [9] D.L. Uribe Santos, J.A. Delgado Dobladez, V.I. Águeda Maté, S. Álvarez Torrellas, M. Larriba Martínez, Recovery and purification of acetic acid from aqueous mixtures by simulated moving bed adsorption with methanol and water as desorbents, *Sep. Purif. Technol.* 237 (2020) 116368. doi:<https://doi.org/10.1016/j.seppur.2019.116368>.
- [10] G. Moretto, I. Russo, D. Bolzonella, P. Pavan, M. Majone, F. Valentino, An urban biorefinery for food waste and biological sludge conversion into polyhydroxyalkanoates and biogas, *Water Res.* 170 (2020) 115371. doi:<https://doi.org/10.1016/j.watres.2019.115371>.
- [11] S. Notarfrancesco, E. Morselli, G.A. Martinez, W. Harasimiuk, J.M.B. Domingos, A. Negroni, F. Fava, L. Bertin, Improved recovery of carboxylic acids using sequential cationic-anionic adsorption steps: A highly competitive ion-equilibrium model, *Sep. Purif. Technol.* 261 (2021) 118253. doi:10.1016/j.seppur.2020.118253.
- [12] Y.-H. Weng, H.-J. Wei, T.-Y. Tsai, W.-H. Chen, T.-Y. Wei, W.-S. Hwang, C.-P. Wang, C.-P. Huang, Separation of acetic acid from xylose by nanofiltration, *Sep. Purif. Technol.* 67 (2009) 95–102. doi:<http://dx.doi.org/10.1016/j.seppur.2009.03.030>.
- [13] J. Zdarta, A. Thygesen, M.S. Holm, A.S. Meyer, M. Pinelo, Direct separation of acetate and

- furfural from xylose by nanofiltration of birch pretreated liquor: Effect of process conditions and separation mechanism, *Sep. Purif. Technol.* 239 (2020) 116546. doi:<https://doi.org/10.1016/j.seppur.2020.116546>.
- [14] M.-P. Zacharof, S.J. Mandale, P.M. Williams, R.W. Lovitt, Nanofiltration of treated digested agricultural wastewater for recovery of carboxylic acids, *J. Clean. Prod.* 112 (2016) 4749–4761. doi:[10.1016/J.JCLEPRO.2015.07.004](https://doi.org/10.1016/J.JCLEPRO.2015.07.004).
- [15] T. Jänisch, S. Reinhardt, U. Pohnsner, S. Böringer, R. Bolduan, J. Steinbrenner, H. Oechsner, Separation of volatile fatty acids from biogas plant hydrolysates, *Sep. Purif. Technol.* 223 (2019) 264–273. doi:<https://doi.org/10.1016/j.seppur.2019.04.066>.
- [16] B. Xiong, T.L. Richard, M. Kumar, Integrated acidogenic digestion and carboxylic acid separation by nanofiltration membranes for the lignocellulosic carboxylate platform, *J. Memb. Sci.* 489 (2015) 275–283. doi:[10.1016/j.memsci.2015.04.022](https://doi.org/10.1016/j.memsci.2015.04.022).
- [17] F. Zhou, C. Wang, J. Wei, Separation of acetic acid from monosaccharides by NF and RO membranes: Performance comparison, *J. Memb. Sci.* 429 (2013) 243–251. doi:<http://dx.doi.org/10.1016/j.memsci.2012.11.043>.
- [18] EU project, No Agro-Waste, (2016). <https://noaw2020.eu/> (accessed July 7, 2020).
- [19] C.S. López Garzón, A.J.J. Straathof, Recovery of carboxylic acids produced by fermentation., *Biotechnol. Adv.* 32 (2014) 873–904. doi:[10.1016/j.biotechadv.2014.04.002](https://doi.org/10.1016/j.biotechadv.2014.04.002).
- [20] Spiral Wound Membranes | RO Membranes | SUEZ, (n.d.). <https://www.suezwatertechnologies.com/products/spiral-wound-membranes> (accessed August 3, 2021).
- [21] Spiral-Wound Nanofiltration Elements, (n.d.). <https://synderfiltration.com/nanofiltration/spiral-wound-elements/> (accessed August 3, 2021).
- [22] S. Bandini, V. Morelli, Effect of temperature, pH and composition on nanofiltration of mono/disaccharides: Experiments and modeling assessment, *J. Memb. Sci.* 533 (2017) 57–74. doi:<https://doi.org/10.1016/j.memsci.2017.03.021>.
- [23] S. Bandini, V. Morelli, Mass transfer in 1812 spiral wound modules: Experimental study in dextrose-water nanofiltration, *Sep. Purif. Technol.* 199 (2018) 84–96.

- doi:<https://doi.org/10.1016/j.seppur.2018.01.044>.
- [24] G.A. Martinez, S. Rebecchi, D. Decorti, J.M.B. Domingos, A. Natolino, D. Del Rio, L. Bertin, C. Da Porto, F. Fava, Towards multi-purpose biorefinery platforms for the valorisation of red grape pomace: production of polyphenols, volatile fatty acids, polyhydroxyalkanoates and biogas, *Green Chem.* 18 (2016) 261–270. doi:10.1039/C5GC01558H.
- [25] R. Wang, S. Lin, Pore model for nanofiltration: History, theoretical framework, key predictions, limitations, and prospects, *J. Memb. Sci.* (2020) 118809. doi:<https://doi.org/10.1016/j.memsci.2020.118809>.
- [26] S. Bandini, J. Drei, D. Vezzani, The role of pH and concentration on the ion rejection in polyamide nanofiltration membranes, *J. Memb. Sci.* 264 (2005) 65–74. doi:<https://doi.org/10.1016/j.memsci.2005.03.054>.
- [27] J.-H. Choi, K. Fukushi, K. Yamamoto, A study on the removal of organic acids from wastewaters using nanofiltration membranes, *Sep. Purif. Technol.* 59 (2008) 17–25. doi:<http://dx.doi.org/10.1016/j.seppur.2007.05.021>.
- [28] S.K. Maiti, Y. Lukka Thuyavan, S. Singh, H.S. Oberoi, G.P. Agarwal, Modeling of the separation of inhibitory components from pretreated rice straw hydrolysate by nanofiltration membranes, *Bioresour. Technol.* 114 (2012) 419–427. doi:<https://doi.org/10.1016/j.biortech.2012.03.029>.
- [29] G. Hagemeyer, R. Gimbel, Modelling the salt rejection of nanofiltration membranes for ternary ion mixtures and for single salts at different pH values, *Desalination.* 117 (1998) 247–256. doi:[https://doi.org/10.1016/S0011-9164\(98\)00109-X](https://doi.org/10.1016/S0011-9164(98)00109-X).
- [30] L. Bruni, S. Bandini, The role of the electrolyte on the mechanism of charge formation in polyamide nanofiltration membranes, *J. Memb. Sci.* 308 (2008) 136–151. doi:<https://doi.org/10.1016/j.memsci.2007.09.061>.
- [31] D.L. Oatley-Radcliffe, S.R. Williams, M.S. Barrow, P.M. Williams, Critical appraisal of current nanofiltration modelling strategies for seawater desalination and further insights on dielectric exclusion, *Desalination.* 343 (2014) 154–161. doi:<https://doi.org/10.1016/j.desal.2013.10.001>.
- [32] F. Zhou, C. Wang, J. Wei, Simultaneous acetic acid separation and monosaccharide

concentration by reverse osmosis, *Bioresour. Technol.* 131 (2013) 349–356.  
doi:<https://doi.org/10.1016/j.biortech.2012.12.145>.

- [33] Y.H. Cho, H.D. Lee, H.B. Park, Integrated Membrane Processes for Separation and Purification of Organic Acid from a Biomass Fermentation Process, *Ind. Eng. Chem. Res.* 51 (2012) 10207–10219. doi:[10.1021/ie301023r](https://doi.org/10.1021/ie301023r).