

Article

GD (Generative Design) Applied to a Plastics Recovery Drone (PRD) Using IDeS (Industrial Design Structure)

Leonardo Frizziero ^{*}, Alfredo Liverani , Giampiero Donnici , Enrico Conti, Beatrice Dello Preite, Umberto Lamanna, Christian Leon-Cardenas ^{*} and Matteo Garulli

Department of Industrial Engineering Viale Risorgimento, Alma Mater Studiorum University of Bologna, I-40136 Bologna, Italy; alfredo.liverani@unibo.it (A.L.); giampiero.donnici@unibo.it (G.D.); enrico.conti16@studio.unibo.it (E.C.); beatrice.dellopreite@studio.unibo.it (B.D.P.); umberto.lamanna@studio.unibo.it (U.L.); matteo.garulli@studio.unibo.it (M.G.)

^{*} Correspondence: leonardo.frizziero@unibo.it (L.F.); christian.leon2@unibo.it (C.L.-C.)

Abstract: The evolution of innovative and systematic design methodologies over time has widened the design concept involvement from the product development phase, which also includes the production and start-up phases. Literature findings have presented to accomplish a Generative Design (GD) approach through the application of an innovative method called Industrial Structure Design (IDeS), a systematic design method able to discover the customer's needs and the fundamental technical solutions to obtain a good innovative product, involving the whole organization for this achievement. Nevertheless, there is a social demand for solutions to the dramatic and growing problem of marine pollution from plastic materials, encouraging the designers to conceive a new innovative drone for waste collection at sea. Therefore, this study aims to merge all the most advanced design technologies with IDeS in an integrated way, by generating a structure that can also be adopted to plan the organization of a production company. The approach is validated with the design of the Recovery Plastic Drone (RPD) obtained with the IDeS methodology, combining Design and Product development phases, leading to a better and innovative solution for the market.

Keywords: industrial design structure (IDeS); quality function deployment (QFD); stylistic design engineering (SDE); Generative Design (GD); Design Sea; Plastics Recovery Drone (PRD)



Citation: Frizziero, L.; Liverani, A.; Donnici, G.; Conti, E.; Dello Preite, B.; Lamanna, U.; Leon-Cardenas, C.; Garulli, M. GD (Generative Design) Applied to a Plastics Recovery Drone (PRD) Using IDeS (Industrial Design Structure). *Inventions* **2021**, *6*, 82. <https://doi.org/10.3390/inventions6040082>

Academic Editors: Chun-Liang Lin and Kambiz Vafai

Received: 13 September 2021
Accepted: 2 November 2021
Published: 5 November 2021

Publisher's Note: MDPI stays neutral with regard to jurisdictional claims in published maps and institutional affiliations.



Copyright: © 2021 by the authors. Licensee MDPI, Basel, Switzerland. This article is an open access article distributed under the terms and conditions of the Creative Commons Attribution (CC BY) license (<https://creativecommons.org/licenses/by/4.0/>).

1. Introduction

This work illustrates a new and innovative methodology for the development of an industrial project through the use of advanced design techniques. Generative Design (GD) is a methodology that uses tools such as Quality Functions Deployment (QFD) or Stylistic Design Engineering (SDE) to help engineers and designers to develop a new product. Over time, the GD methodology has evolved into the more modern Design for Six Sigma (DFSS) methodology, deployed in with the product development phases through the use of other tools such as Benchmarking (BM), Top-flop Analysis (TFA) and Product Architecture [1,2]. Furthermore, as GD methodology proved to be a valid choice to design for applications, it does not involve other key company areas to seamlessly integrate the design criteria across all production and manufacturing departments. The evolution of GD approach is called Industrial Design Structure (IDeS).

Moreover, this document aims to explain the application of the IDeS methodology for product development. IDeS is a design-based method to gather the appropriate organization structure needed to seamlessly develop a product designed accurately for a specific market segment, and that needs to be put into production in a short time. Therefore, IDeS methodology would organize the design steps of industrial projects, allowing to generate a link between the design structure and the company organization. With this process, IDeS methodology proves to deliver a customer-centered product by taking into account the industrialization part, which is of great importance in order to throw a high quality

product that would be economically feasible to the organization. Figure 1 summarizes the IDeS methodology as a procedure which involves both product development and start-up phases, leading to adopt a different company organization. This method is an evolution from past, well-known design methodologies like QFD and SDE, which englobe the GD approach, and DFSS that has been accepted by industries worldwide for reaching high quality levels, by using tools like the Top–Flop Analysis (TFA), Benchmarking (BM) and Product Architecture deployment. Different research findings about the application of this methodologies demonstrated the objective to gather a full project concept approach to provide the designer with a scheme that could guide them through the work for best results across all departments [3–6]. However, it can be used across many industries such as automotive, electronics, information technology, marketing, waste management and medical plants.

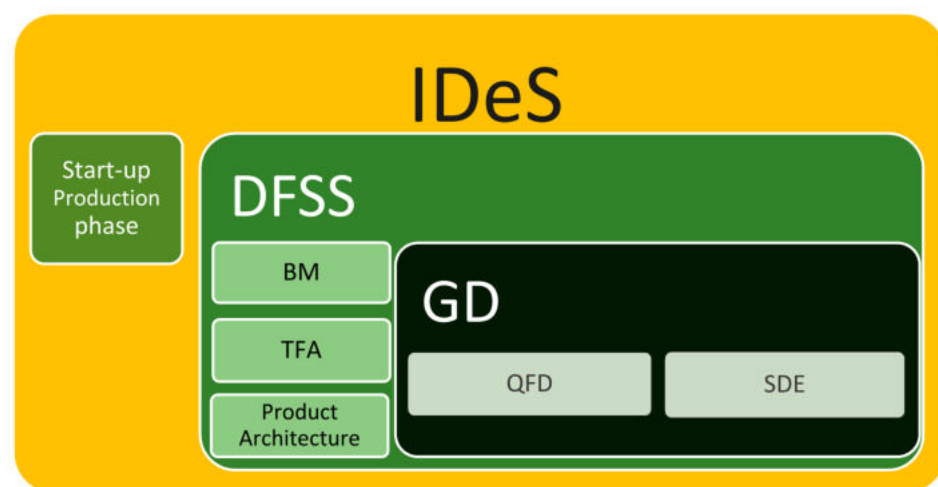

Figure 1. IDeS methodology embraces other product design methods and includes initial production phase.

The development and diffusion of the methodology are demonstrated by the increasing presence of scientific articles dealing with this topic. Research conducted by Javid Butt [7] deals with the implementation of enabling technologies of industry 4.0 through Lean Six Sigma approaches. To this end, he considered the best practices existing in the field of marketing and management of production technology. The methodologies examined include the Quality Function Deployment (QFD) and Design for Six Sigma (DFSS) approach.

Similarly, O.M. Ikumapayi et al. and E.V. Gijo et al. [8,9] compared the results produced in the field of Six Sigma by the most recent methodologies that help organizations to reduce defects whilst reducing overall cycle time.

Likewise, the work conducted by Siddra Qayyum [10] compares the DMADV methodology [11,12] with the DFSS methodology. The first considers the development of products that do not yet satisfy the customer's aspiration. Conversely, the DFSS methodology aims to optimize production processes based on customer needs. An example of application of the methodology is given by the work of I.A. Daniyan et al. [13] that uses the interactive approach of acquisition, data processing and exchange of ideas between users and the system, typical of the DFSS methodology to create internal and external accessories for railway wagons. A second application example is provided by Ana Luisa Oliveira da Nóbrega Costa et al. [14], who designed an assistive device that allows people with quadriplegia to play Paralympic tennis.

Subsequently, previous research has been performed with the intention of expanding previously known design methodologies, like SDE [3] and QFD, towards IDeS methodology by means of including additional production-wise approaches. Trials have been made about conceiving a futuristic family car [5], a city car [15] and a futuristic mobility solution [16], solutions of which started to build up the design approach together with the feedback

of other project development areas including production. The proposed product set-up phases can be seen in Figure 2. Later, a description of GD was made by Briard, Segonds and Zamariola [17] as a set of know-hows which would indicate the main design parameters, or to optimize an existing design, in order to take on previous defined criteria by the end user. This approach to a design decision rules out that a complete analysis must be taken prior to beginning to analyze the different design options of the part. The research of Marinov et al. [18] states that the GD approach is keen to synthesize design choices by analyzing the whole part in order to reach objectives. This approach could also be useful to gather every relevant input of the part, like simulation parameters, comparison criteria and final market scope decisions.

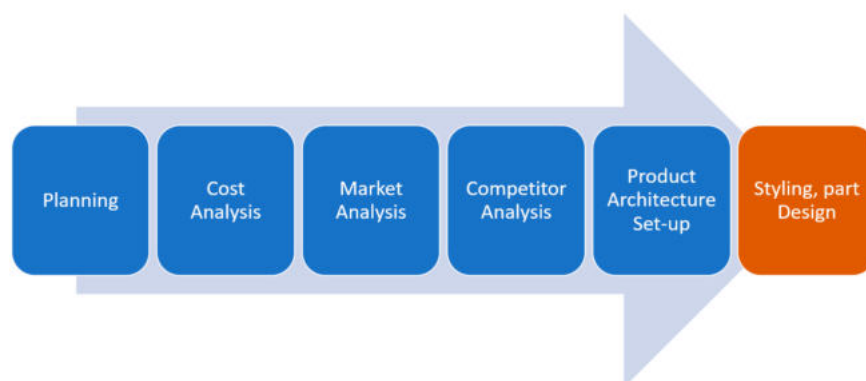

Figure 2. IDeS product set-up phase.

Meanwhile, recent discoveries about the application of numerical methods would allow to improve the development of compact communication devices with the Beam Propagation Method (BPM) by means of a new compact wavelength demultiplexer by Malka [19], which allows to implement a communication device that uses a slot-waveguide that also overcomes path-loss, allowing to obtain a high bit rate, supporting to transmit light without restriction losses. Another method, this time applying the Finite-difference time-domain (FDTD), could also aim to combine multiple coherent sources on integrated circuits [20].

Nevertheless, in recent years, due to the increase in global plastic production and poor waste collection, marine pollution has increased significantly. To date, however, few reports have focused on the development and mobilization of technologies that harvest marine plastic pollution [21,22]. This case study was considered for an application of the IDeS methodology. Consequently, the design of a drone for plastic recovery at sea can be revealed as an answer to fill this gap. This study explains how the IDeS methodology was applied to the design of a Plastic Recovery Drone (PRD) on the basis of a careful environmental and market analysis that represents an innovative solution to the problem of marine pollution.

2. Materials and Methods

In order to apply the IDeS methodology (Figure 3), an understanding of the three main phases in which it is structured is needed:

1. Design Setting.
2. Product Development.
3. Production setup.

The first two phases mainly involve the figures of designers and mechanical engineers, while the third belongs to manufacturing and production technicians. Furthermore, GD methodology establishes that an accurate styling design engineering must be obtained to generate feasible design solutions, by including diverse tools to evaluate the feasibility of these potential solutions. Therefore, GD would use all the tools included in the Design setting of the IDeS methodology outlined in Figure 3.

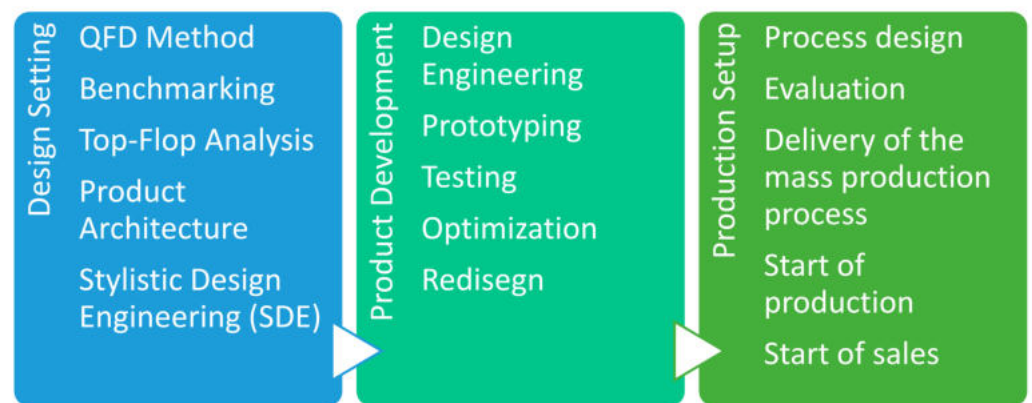

Figure 3. Industrial Design Structure Methodology.

This report concerned the first two phases of the methodology, aiming to deliver a production-ready element, just for its final acceptance before the production processes design step. Therefore, the described procedure can be summarized in the following design phases:

1. Define: includes an environmental analysis, a market analysis and the declaration of objectives.
2. Measure: includes the development of the Quality Function Deployment.
3. Analyze: includes Benchmarking, Top–Flop Analysis and the WHAT/HOW Relationship Matrix.
4. Design: includes Product Architecture and Stylistic Design Engineering (SDE).
5. Validate: consists in the production of the prototype. It is essential that it is in line with the required characteristic.

2.1. Design Setting

2.1.1. QFD Method

QFD is a methodology that starts from a careful market and competition analysis and provides mechanical designers a better understanding of the customer's needs and requirements. This is essential in order to define what the project objectives are. Consequently, it is possible to develop solutions that respond positively to customer requests [23,24].

The tools of the QFD methodology are:

1. The Six Questions.
2. The Matrix of the Relations of Dependence/Independence.
3. The Matrix of Relationships of Relative Importance.

Six questions identify the characteristics that the product must possess. They are the following:

- (a) Who: Who is the product for?
- (b) What: What is the function of the product?
- (c) How: How is the product used?
- (d) Where: Where is the product used?
- (e) When: When is the product used?
- (f) Why: What is its purpose?

The Matrix of the Relations of Dependence/Independence is a table that shows on the rows and columns the main characteristics that the product must have according to the analysis carried out with the six questions.

It is worth considering how much the requirements on the rows are dependent on the requirements placed on the columns, determining cause-and-effect relationships between the product requirements. Depending on the type of relationship, each cell is assigned a numeric value which can be 0, 1, 3 or 9.

In particular, the value is assigned:

- 0 = the relationship between the characteristic of the row and the column is null.
- 1 = the relationship between the characteristic of the row and the column is weak.
- 3 = the relationship between the characteristic of the row and the column is average.
- 9 = the relationship between the row and column characteristic is strong.

Moreover, in the case of the Matrix of Relationships of Relative Importance, it is proceeded by placing on the rows and columns the main characteristics that the product must have and which emerged from the analysis carried out with the six questions.

One concern may be to what extent the requirements on the rows are more or are less important than the requirements on the columns. Depending on the type of relationship, each cell is assigned a numerical value from 0 to 2. In particular, the value is assigned:

- 0 = the characteristic of the row is more important than the column.
- 1 = the characteristic of the row and the column have the same importance.
- 2 = the characteristic of the column is more important than the row.

2.1.2. Benchmarking and Top–Flop Analysis

Benchmarking is a methodology that, through a careful comparison with the competition or with the products previously made, allows designers to understand the limits to be overcome in order to innovate.

Therefore, competitive or previously manufactured products are considered, and the most relevant technical characteristics are illustrated for each of them. In this way, the benchmarking matrix is built.

The next step concerns a Top–Flop Analysis, which consists of a quantitative study of the best (top) and worst (flop) characteristics of each product examined. The differences between tops and flops for each element are then considered. The highest Δ score among the differences obtained indicates the minimum number of innovative product features in the design phase.

Once the number of characteristics to be innovated has been established, it is necessary to find out which ones they are. To this end, the What–How Matrix is considered, which reconciles the results obtained for the relationship matrices with those found through Top–Flop Analysis. The matrix has as rows the fundamental requirements of the product obtained through the relationship matrices and as columns the technical characteristics considered by the analysis of competitive products. Each box is assigned a number that can be 0, 1, 3 or 9 according to the degree of influence that the characteristics considered have on the requirements of the product to be manufactured. By adding the values obtained for each column, the characteristics of the product to be innovated are obtained.

2.1.3. Product Architecture

This underlies the scheme by which the individual functions of the product are attributed to its physical components. It is a system design that allows the designer to have an overall view of both the aesthetics and the functional part of the project [25,26].

2.1.4. Stylistic Design Engineering (SDE)

Stylistic Design Engineering (SDE) is an engineering approach that enables the development of industrial design projects. It involves the following stages:

1. Analysis of stylistic trends.
2. Freehand sketches, essential for outlining the first drafts of the prototype.
3. Two-dimensional (2D) drawing done with modeling software such as *AutoCAD* (Autodesk Inc., San Rafael, CA, USA). This phase allows you to estimate the right measurements and proportions.
4. Three-dimensional (3D) model obtained with 3D modeling software such as *PTC Creo* (PTC Inc., Boston, MA, USA).

5. Rendering performed with rendering software such as *Keyshot (Luxion Inc., Aarhus, Denmark)* and *Vred (Autodesk Inc., San Rafael, CA, USA)*.

2.2. Product Development

2.2.1. Design Engineering

In the design engineering phase, the dimensions, materials and technologies to be used for the model are determined. Two- and three-dimensional (2D and 3D) modeling software is used for this purpose.

2.2.2. Prototyping and Rendering of Product

Prototypes can be digitally made, to gather aesthetics performance—functional and virtual. The digital prototyping phase takes place through parametric CAD software that allows to easily make changes to the parameters. The product rendering phase allows to obtain an aesthetic prototype with the help of rendering software such as Keyshot and Vred. Functional prototyping allows to obtain prototypes in 1:1 scale. Finally, the virtual prototype is obtained through augmented reality.

2.3. Case Study

2.3.1. GD Definition—QFD Method

The first tool to be used in the QFD methodology concerns the Six Questions. The idea is to design a marine drone capable of solving the problem of plastic at sea. The drone should therefore be used daily and operate in marine areas where the greatest accumulation of waste occurs.

2.3.2. GD Measure

The Matrix of the Relations of Dependence/Independence

From a careful analysis of the customer’s needs and requests, the following list of requirements for the product has been reached: 1. Simplicity, 2. Reliability, 3. Aesthetics, 4. No degradability, 5. Resistance, 6. Modularity, and 7. Traceability.

These characteristics are used in the relationship matrices exhibited in Table 1, representing the Matrix of dependence/independence interactions which identifies the main requirements that the product must have in terms of the cause-effect relationship. Subsequently, the main requirements to be included are 3. Aesthetics (54), 1. Simplicity (34), 4. No degradability (33), and 7. Traceability (27).

Table 1. Dependence/Independence Matrix.

	1.	2.	3.	4.	5.	6.	7.
1. Simplicity	-	9	9	3	3	1	9
2. Reliability	9	-	9	3	0	1	0
3. Aesthetics	9	9	-	9	9	0	9
4. No degradability	1	0	9	-	0	9	0
5. Resistance	9	0	9	0	-	0	0
6. Modularity	3	3	9	9	1	-	9
7. Traceability	3	3	9	9	9	9	-
Total	34	24	54	33	22	20	27

The Matrix of Relationships of Relative Importance

Meanwhile, the Relative Importance Matrix helps designers to identify the most important requirements for customers to implement in the new product. Table 2 shows the scoring of this requirements, resulting in 2. Reliability (11), 5. Resistance (11), 4. No Degradability (9), and 7. Traceability (9).

Table 2. Relative Importance Relationship Matrix.

	1.	2.	3.	4.	5.	6.	7.
1. Simplicity	1	2	0	2	2	0	2
2. Reliability	0	1	0	1	1	0	0
3. Aesthetics	2	2	1	2	2	2	2
4. No degradability	0	1	0	1	1	0	2
5. Resistance	0	1	0	1	1	0	0
6. Modularity	2	2	0	2	2	1	2
7. Traceability	0	2	0	0	2	0	1
Total	5	11	1	9	11	3	9

By adding together the particular characteristics that emerged from the two matrices, it is possible to obtain the following list of requirements: 1. Simplicity, 2. Reliability, 3. Aesthetics, 4. No Degradability, 5. Resistance, and 7. Traceability.

2.3.3. GD Analyze—Benchmarking and Top–Flop Analysis

The main solutions for collecting marine plastic pollution on the market are illustrated in Figure 4. The first solution analyzed is called “Waste Shark”. It is a remote-controlled drone manufactured by the Dutch company *Rainmarine*. Its special characteristics include a great agility that allows it to collect plastic fragments even in small spaces. It also represents an eco-friendly solution. Among the disadvantages, it has a limited autonomy [27]. The second possibility is called “Seabin”. It is a basket immersed in water and connected to an electric suction pump that attracts floating waste. The garbage ends up in a bag made of natural fibers and a separator cleans the water that will be returned to the sea. The special characteristics represented by this solution are the economy and the small size of the basket which collects waste even in limited spaces. Disadvantages include a reduced capacity to contain waste, difficulty in disposing of waste in the shortest possible time and the consumption of electricity [28]. The third option is represented by “Le Manta”, a latest generation catamaran designed by French sailor Yvan Bourgnon which has a very efficient waste collection capacity but requires constant management by dedicated equipment and a high cost [29]. The last solution analyzed is given by *Boyan Slat’s* “Ocean Clean Up”. It consists of a barrier that exploits the flow of sea currents, allowing the plastic to be conveyed inside. The special feature concerns the autonomy of the project which does not require constant supervision [30].

Benchmarking was performed by means of the matrix shown in Table 3. It lists the unique characteristics of each possible approach, with the most important for this project acceptance being to have rather compact dimensions, eco-friendliness (i.e., to cause lower impact on the sea water and its wildlife), enough storage capacity and no emissions. Furthermore, the innovative and valuable characteristics (Top Characteristics) are highlighted in green, and the worst characteristics (Flop characteristics) are highlighted in red. The Benchmarking Matrix created allowed to easily perform the Top–Flop Analysis shown in Table 4. In it, the top and flop characteristics of each solution are counted, and their difference delta (Δ) is calculated. The highest score among the differences found is 3. This means that, to innovate, it is necessary that the drone to be built must have at least three innovative features.

Finally, through the What–How Matrix represented in Table 5, it is possible to trace which are the technical characteristics to be considered as the target of the new project in order to have an innovative product. These characteristics are Autonomy, Capacity, Recovery and Control.

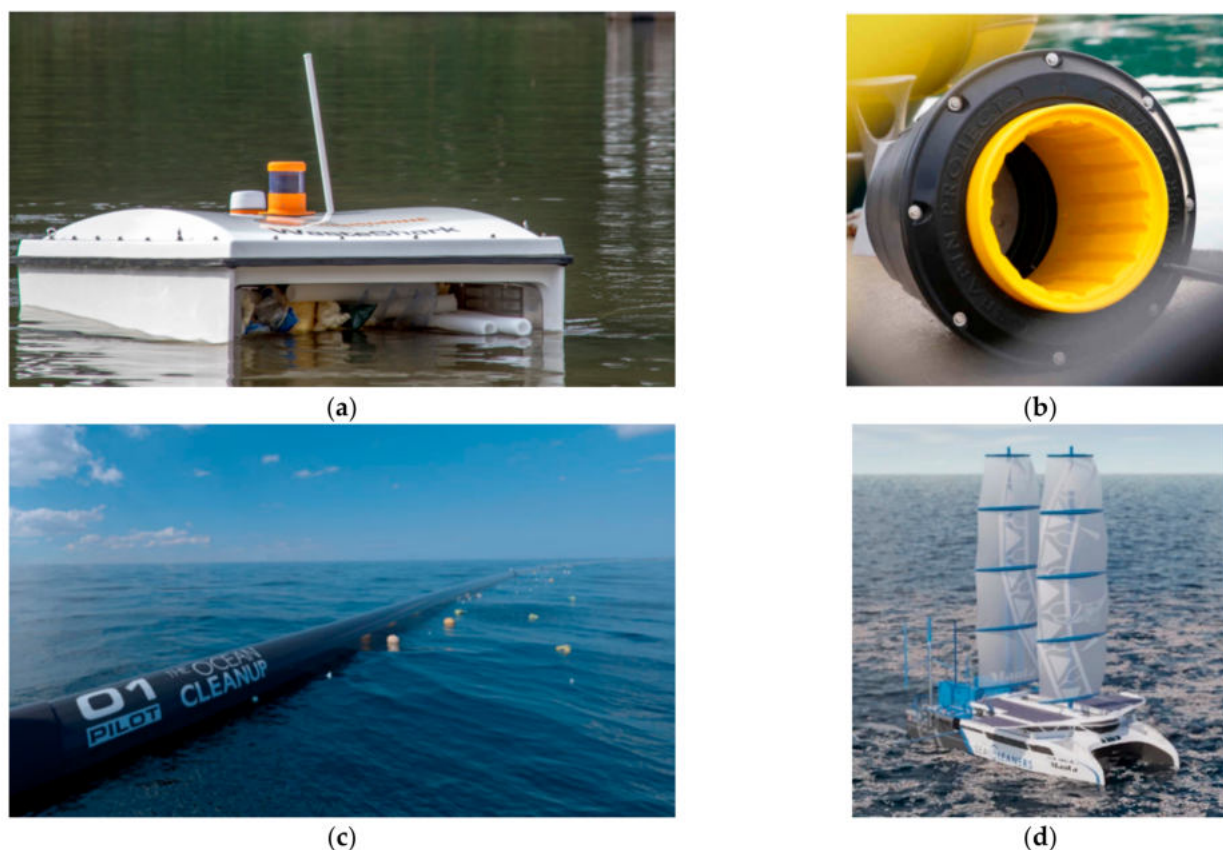

Figure 4. Main solutions for collecting marine plastic pollution on the market: (a) *WasteShark*; (b) *Seabin*; (c) *OceanCleanUp*; (d) *Le Manta*.

Table 3. Benchmarking Matrix.

	Le Manta	Waste Shark	Ocean Clean Up	Seabin	Innovation
Dimensions (m)	70 × 49 × 61	1.55 × 1 × 0.45	600	0.9 × 0.5 × 1.8	0.9 × 0.5 × 1.8
Eco-Friendly	DiD	Symbiosis	ND	ND	Symbiosis
Capacity	300,000 L	200 L	ND	20 Kg	300,000 L
Cost (EUR)	150,000	15,000	1860.531	200	200
Autonomy	Fully	24 h	Fully	1 Month	Fully
Recovery	Immediate stock	Collection & Monitoring	Accumulation	Accumulation	Immediate
Control	Ship's Company	Remote or Track	Automatic	Manual	Automatic
Consumption	Renewable energy	Renewable energy	No emission	Electricity	Renewable energy
Application	Ocean	Canal river	Ocean	Piers or Ports	Ocean

Table 4. Top–Flop Analysis Matrix.

	Le Manta	Waste Shark	Ocean Clean Up	Seabin	Innovation
Top	5	2	3	2	
Flop	2	1	3	5	
Δ	3	1	0	−3	≥3

Table 5. What–How Matrix.

	Dimensions	Eco Friendly	Capacity	Cost	Autonomy	Recovery	Control	Consumption	Application
Reliability	1	9	9	3	9	9	9	0	0
Resistance	0	0	0	3	3	0	0	0	3
No Degradability	0	0	0	3	0	0	0	0	0
Traceability	3	0	0	0	3	9	9	0	3
Simplicity	9	1	9	1	9	9	9	3	3
Aesthetics	0	3	3	9	0	0	0	3	1
	13	13	21	19	24	27	21	6	10

2.3.4. GD Design—Product Architecture

The first aspect analyzed concerns the waste collection method. After some investigation, the choice fell on the use of a compactor. Compaction consists in the pressing of the material to be recycled into shapes of different geometric dimensions depending on the necessary treatment.

The practicality of this solution is conducted for logistical and storage advantage. The reduction of the volume of waste, in fact, allows to increase the load capacity. This aspect allows to reduce the number of mission cycles and therefore to increase the product-service. It was decided to discard other similar solutions such as the use of a shredder because it would not ensure adequate recycling of the waste which, once shredded, could return to the sea.

Another reason why the method of waste compaction and not of shredding was chosen relates to the origin of the materials found in the sea, namely, plastic and cans. To be shredded, these materials use high efficiency components with a high energy consumption not suitable for a device that works for the environment. The idea is in fact to design a drone that operates with a low-consumption energy system. A solution in this regard is represented by the use of solar panels and therefore of clean energy.

After determining the practical method of collection, the research focused on how the drone should move. From the Benchmarking analysis, it emerged that the “OceanCleanUp” has the highest degree of autonomy among the solutions analyzed. In fact, the system navigates autonomously by exploiting the motion of the tides.

It was decided to opt for a “controlled derivative” system, which, by exploiting the motion of the currents, allows the drone to reach the desired point autonomously. However, the management of drone motion in environments subject to strong currents made it necessary to include a propulsion system in the project. Therefore, initial research phase initially concentrated on the use of “Idrojet” engines. They are pumping systems or nautical propulsion consisting of a dynamic intake that allows to intercept a fluid. It is forced into the supply line, is accelerated by the pump and is then expelled through the nozzle.

However, this idea was rejected due to the high maintenance costs caused by the unavoidable ingestion of debris. It was decided to opt for the use of two outboard motors. The advantages deriving from the use of the electric outboard are: high silence, which allows the drone to move without disturbing the marine fauna; high economy; and high performance guaranteed by a light and compact design. The disadvantage of using an electric-powered outboard is its low range. However, being an auxiliary propulsion system used only for short distances, it was still decided to opt for this choice. The architecture of the selected drone is shown in Figure 5.

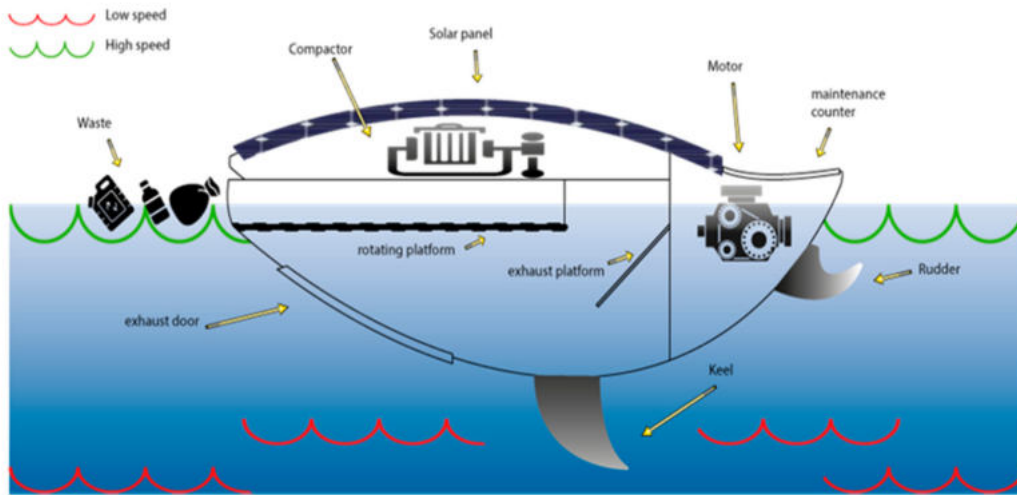

Figure 5. Product Architecture.

Stylistic Design Engineering (SDE)—Nature-Inspired Approach

In order to select the Design approach adapted to the project’s needs, four different styles were analyzed, and drawings were made for each of them.

- A. Stone style. It is characterized by the constant use of rigid lines, often square (Figures 6 and 7).

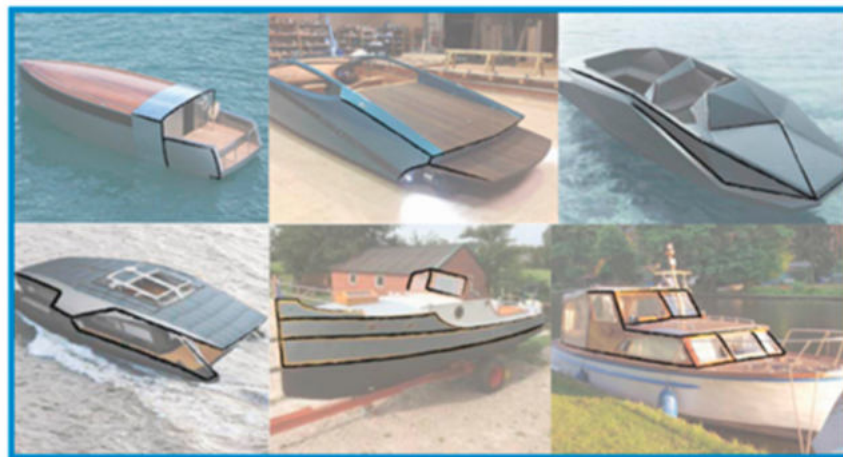

Figure 6. Stone Style Examples.

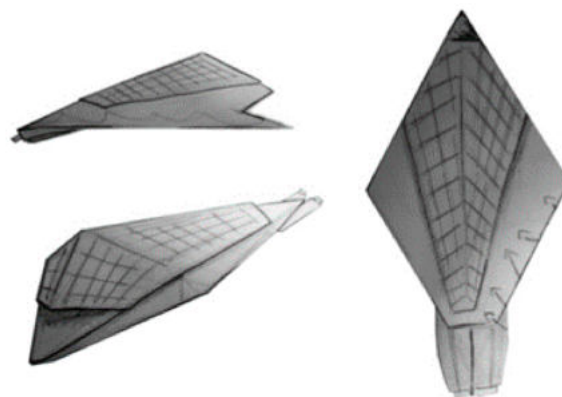

Figure 7. Stone Style Sketches.

B. Retro style. It is characterized by softer and more pleasant lines (Figures 8 and 9).



Figure 8. Retro Style Examples.

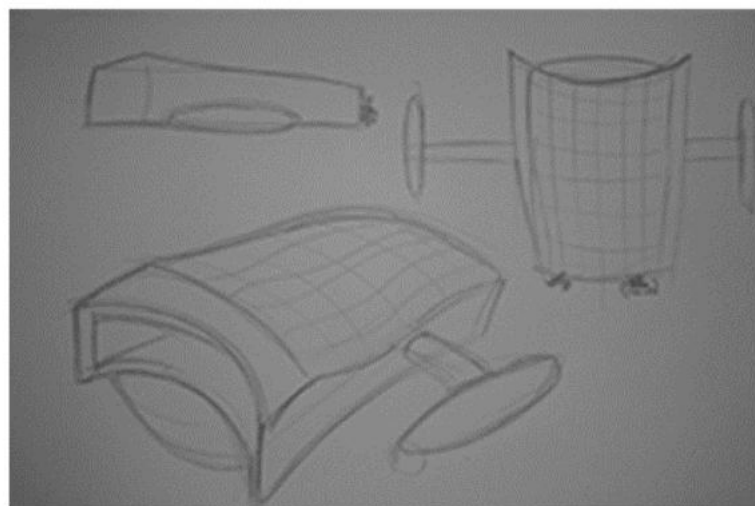

Figure 9. Retro Style Sketch.

C. Futuristic style. It features soft, aerodynamic curves and new futuristic shapes (Figures 10 and 11).



Figure 10. Futuristic Style Examples.

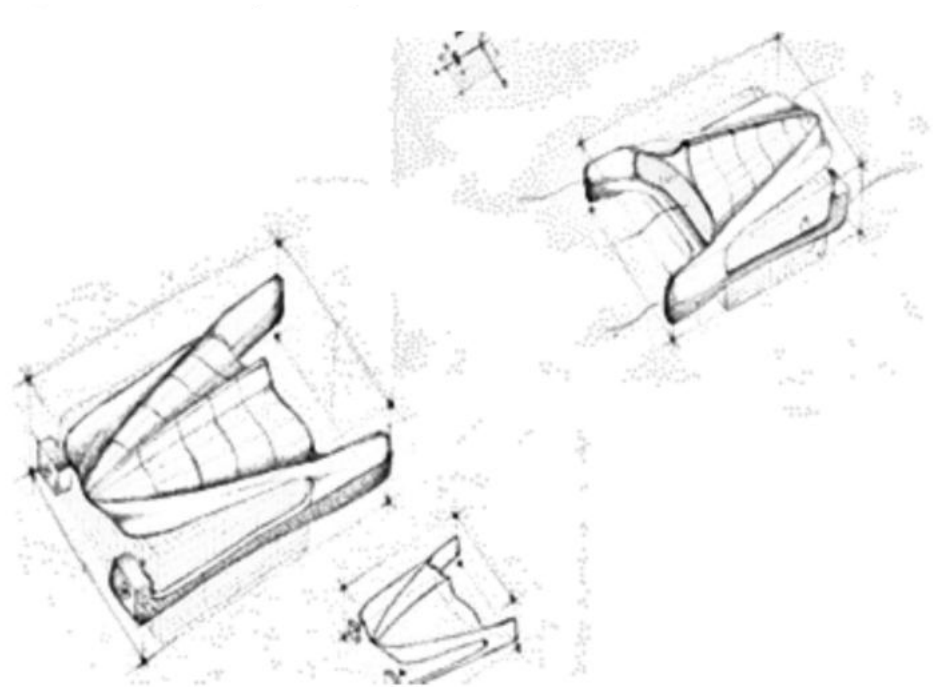

Figure 11. Futuristic Style Sketch.

- D. Natural style. It is characterized by smooth and, above all, zoomorphic lines. The prototype seems to want to integrate into the marine world by assuming its shapes and appearance (Figures 12 and 13).



Figure 12. Natural Style Examples.

In light of the sketches, the natural style was chosen as the reference model. In fact, it was considered necessary to integrate the project with the marine world as much as possible, not only through eco-sustainable design choices, but also through appropriate aesthetic and stylistic choices.

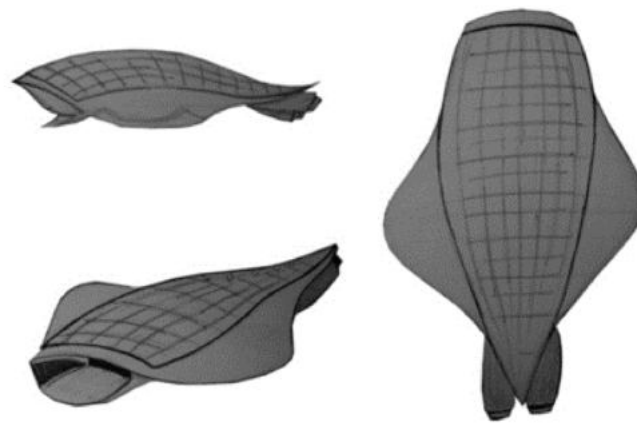

Figure 13. Natural Style Sketch.

Product Architecture Development Design Engineering

One of the first design constraints to emerge through the project was the material choice for the construction of the prototype, as technical characteristics such as adaptability to the sector of use, resistance, unsinkability, and economic and environmental sustainability were considered. Figure 14 represents the orthogonal projections of the drone to be made. In particular, all the dimensions chosen for its prototyping are highlighted.

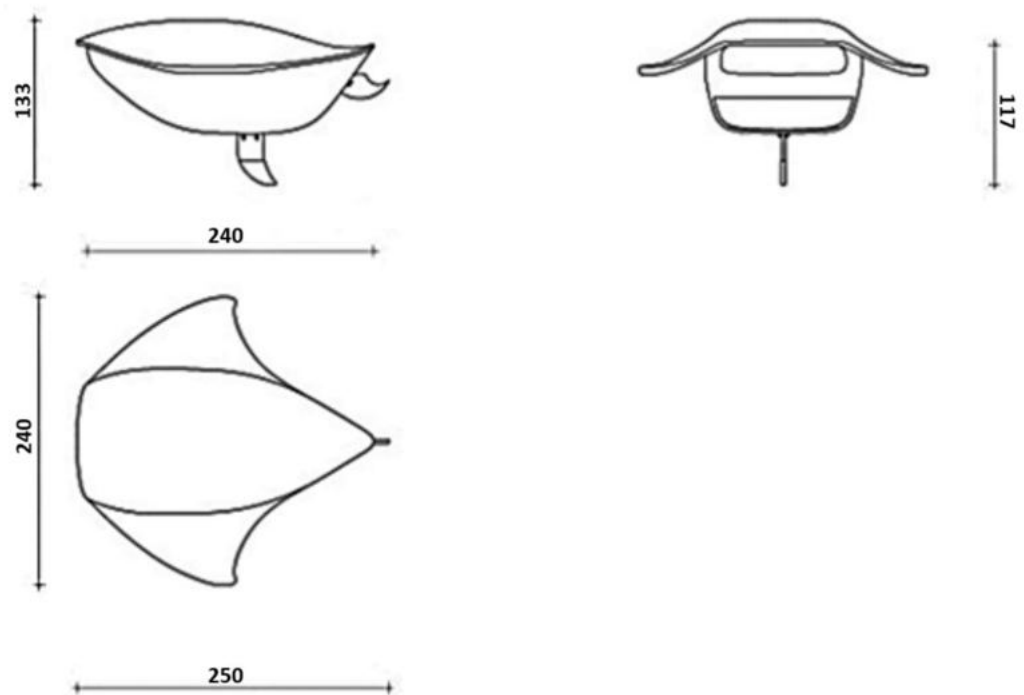

Figure 14. Design engineering: orthogonal projections, measures in (cm).

For this reason, it was decided to use aluminum instead of fiberglass for the construction of the hull. In fact, aluminum allows for the construction of a hull that weighs about half of the corresponding fiberglass units. Therefore, a careful design of the hull has to be developed so that it is possible to guarantee complete unsinkability. The hull drawing after being completed by the software is sent to a plasma cutting machine. It divides the sheet into pieces that are joined by special welding machines. The result is that of a performing hull with a fluid and pleasant design. Another strong point of aluminum choice is its high

impact resistance and its simplicity of processing. This material, in fact, has an impact resistance up to three times higher than that of fiberglass. Additionally, the maintenance costs of aluminum are contained. Finally, the eco-sustainable aspect of the material was considered throughout its life cycle. Aluminum is a totally recyclable material; in fact, at the time of disposal, it is always possible to cut it and bring it back to the raw material level without wasting it. In order to be compliant with current regulations, it was decided to furnish the drone with LED strips to make it visible to nearby ships during the night.

Additionally, as a safety system, it was decided to include an ultrasound deterrent system on the drone, to prevent some marine species from ending up inside it. This solution was designed using technologies such as DDD (Dolphin Dissuasive Device) or DiD (Dolphin Interactive Deterrent).

An efficient monitoring system was in the initial analysis of the project. In this regard, it was necessary to develop dedicated software that can be installed on digital devices such as laptops or tablets and smartphones. This allows to monitor the exact position of the drone at any time in case of a completed mission or for maintenance interventions. Through the involvement of fishing boats, merchant ships, tourism ships or small private boats, it is possible in this way to recover the drone and allow input from citizens to help the project (Figure 15).

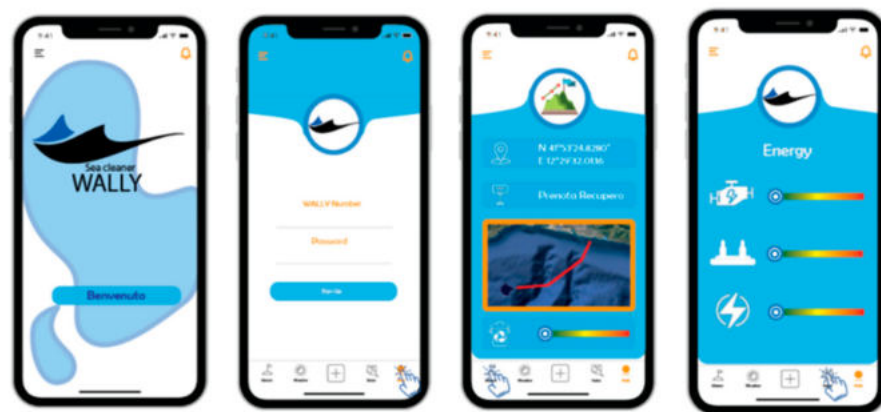

Figure 15. Drone tracking app.

2.3.5. Validation: Prototyping and Rendering of Product

A digital prototyping was carried out for the drone using CAD software (Figure 16). The aesthetic prototype was also created by performing some renderings starting from the 3D digital model (Figure 17). The functional and virtual prototypes are ought to be made after final changes and official design acceptance of the project.

Moreover, a technical element validation process was performed as well, in order to quantify the actual maximum capacity for plastic recovery of the unit. To do so, a parametric CAD model of the element was done (Figure 18) by considering the measures of the functional elements included in the device. Available volume validation accounted for 0.8 m³ of space, in which, translated in waste quantity, values of a maximum number of plastic bottles (0.5 L) was obtained as shown in Table 6 with compacted waste data gathered from the study of Poroschianu et al. [31] and Islam [32]. Designed object volume area was calculated via CAD analysis, as shown in Figure 19.

Subsequently, CFD multiphase (two-fluid) simulations (Figure 20) were performed on the obtained structure in order to check for possible flow turbulences that would compromise the stability at the sea, and to check that water would theoretically not enter into the waste storage area. This resulted in a maximum turbulence of about 25% in such. Fluid flow simulations show a mostly laminar behavior that would guarantee a sleek displacement of the unit in the water.

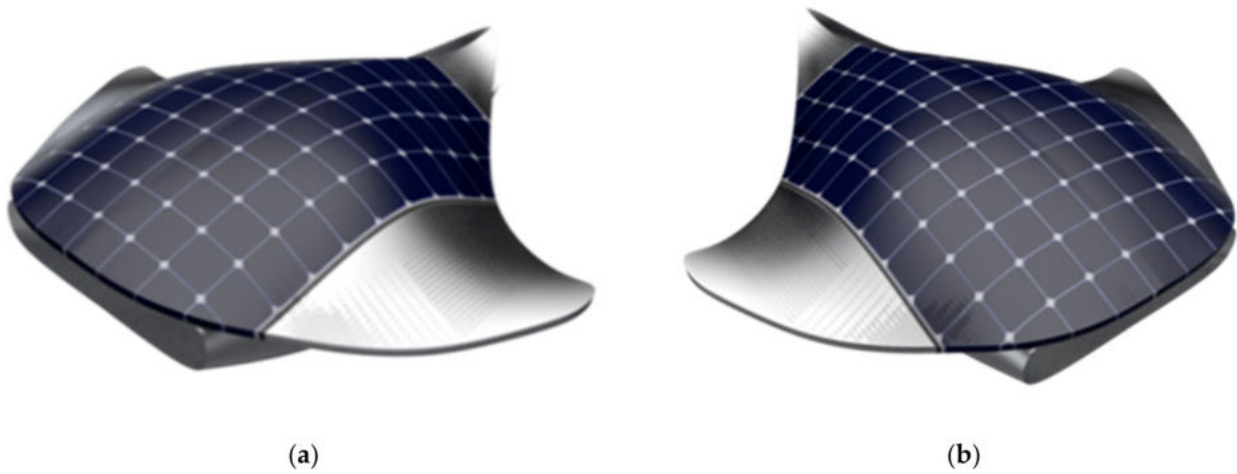

Figure 16. Digital prototype of the marine drone: (a) left side; (b) right side.

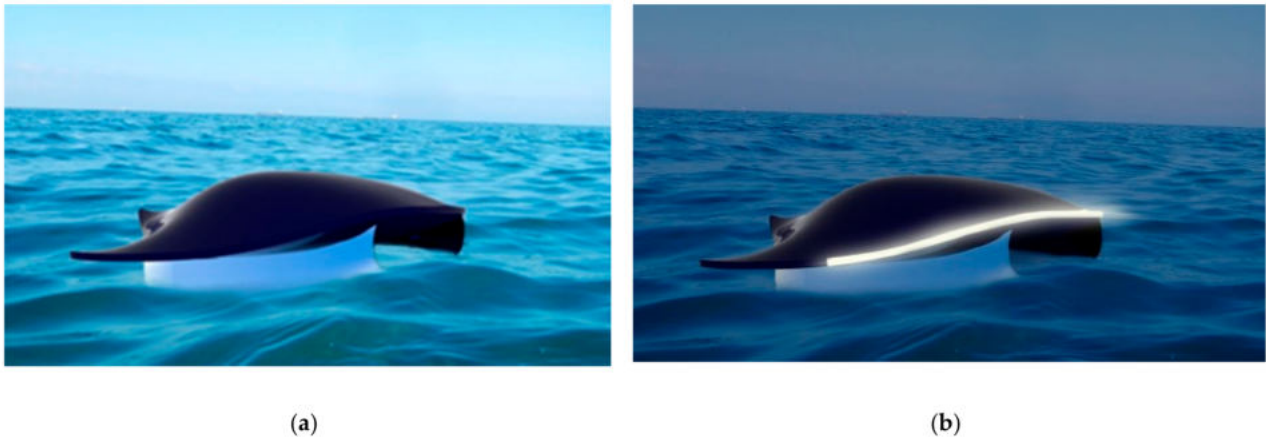

Figure 17. Aesthetic prototype of the marine drone: (a) during the day, (b) during the night.

Table 6. Cargo Volume Capacity Analysis.

Property	Value
Total interior volume (m ³)	1.35
Equipment Volume (m ³): A + C	0.51
Available Waste Volume (m ³)	0.60
Compacted Bottle 0.5 L (20%)	0.1 L
Obtained Capacity (0.5 L bottle, est.)	50,000
Plastic Bottle Weight 0.5 L (est.)	20 gr
Estimated Max Cargo Weight Capacity (Kg)	1000

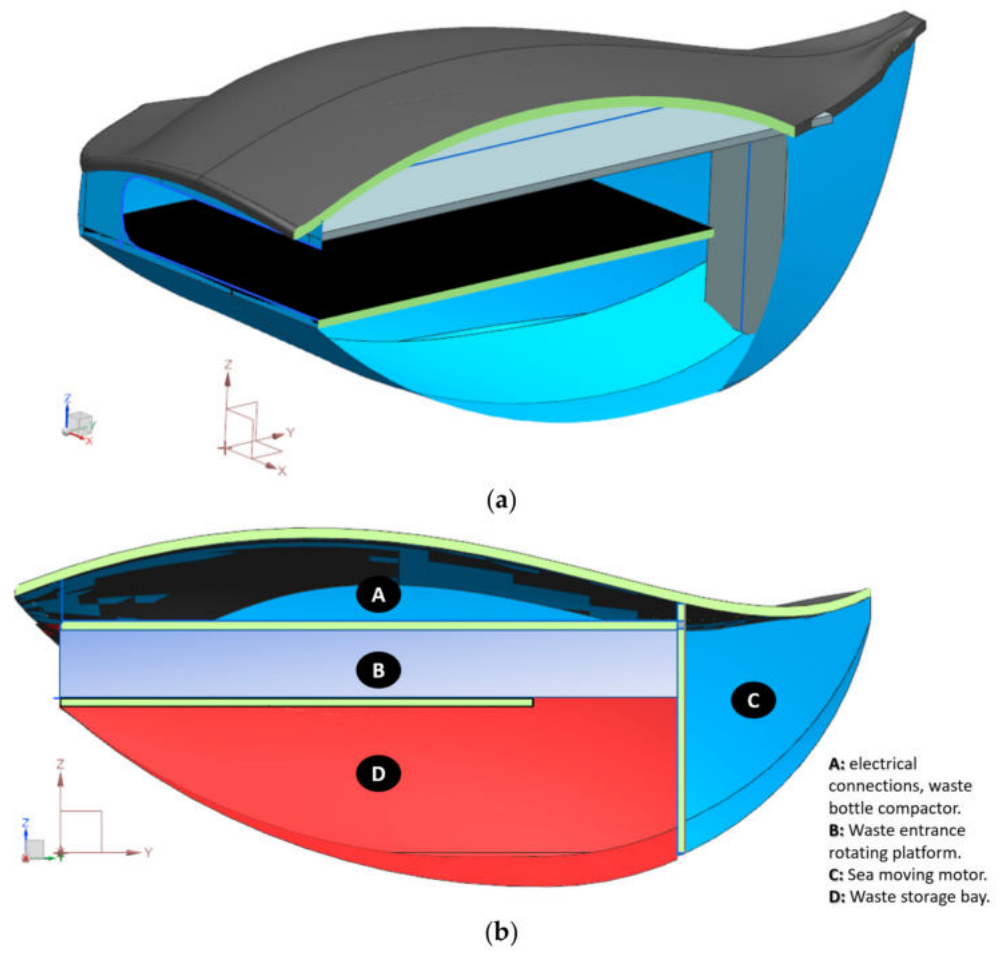

Figure 18. Geometry Validation: (a) $\frac{3}{4}$ internal section view, (b) section view and designated areas.



Figure 19. Volume quantification solids.

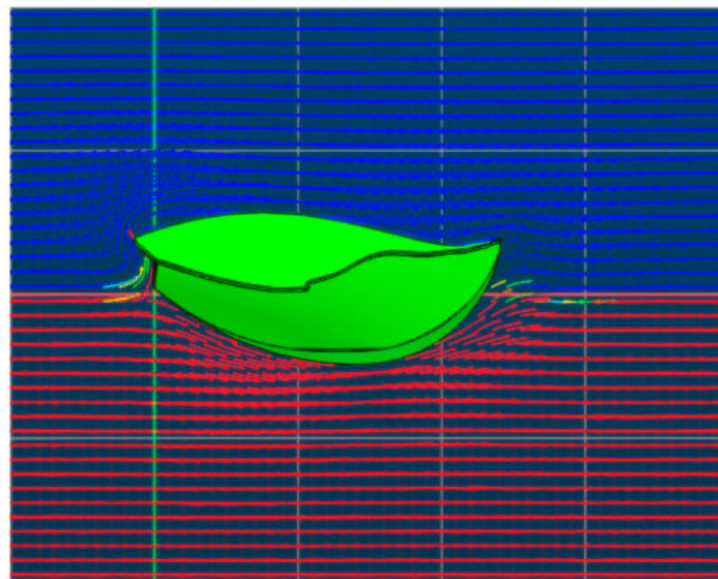

Figure 20. CFD Multiphase Flow Simulation.

2.3.6. Validation: Electrical Devices

Moreover, this study considered that electrical moving parts should be gathered from external sources, according to the final client’s autonomy and budget requirements, as batteries could be installed on section A of Figure 17b. Electricity flow should be measured accurately, and information displayed be in the Drone Tracking Application. Nevertheless, a base element choosing from available suppliers that would fit the established requirements are presented in Table 7; motor energy consumption could undergo an optimization procedure based on the Particle Swarm Optimization algorithm as described by Bacciaglia et al. [33] in order to guarantee longer autonomy if future tests on real prototypes are performed.

Table 7. Electrical Equipment.

Batteries						
Property	Capacity (mAh)	Max Charge Rate (C)	Discharge (c)	Weight (Kg)	Number of Units	Total Payload (Kg)
Value	20,000	2	12	1.775	12	21.3
Motors-Jet 300						
Property	Max Power (W)	Max Current (A)	Working Voltage (V)	Weight in water(g)	Number of units	Total Payload (g)
Value	350	22	6–20V	396	4	1584
Solar Panels-SPP-041751200						
Property	Max Power (W)	Cell Type	Number of cells	Max Voltage (V)	Surface Maximum Load Capacity (Kg/m ²)	Allowable Hail Load
Value	175	Polycrystalline	36	1000	200	23 m/s, 7.53 g

Means for communications can be governed by a Visible Light Communications (VLC) device, which was found to provide no health risk for humans, and can be applied as a communication and illumination device with low energy usage [34]. The VLC could be governed by the compact wavelength demultiplexer developed by Malka [19]. However, further research is needed to implement such communication device.

3. Results

The technical characteristics necessary for the design of the drone emerged from the What–How matrix: autonomy, capacity, recovery and control. Table 8 shows a Top–Flop analysis performed in the last design phase. An innovative product has been obtained through the IdeS method as the total (Δ) resulting from the Top–Flop analysis of the prototype is equal to 4 (>3). In addition, the main features of the new product include autonomy, recovery and control. Satisfactory results were obtained.

Additionally, environment friendliness was achieved, as the created product is a completely green device capable of collecting marine litter and self-managing it during the entire crop flow. An electric motor powered by both battery and some photovoltaic panels placed in the upper part of the drone was installed. Furthermore, by exploiting the motion of the tides, the drone can reach the waste accumulation areas autonomously and without using the engine. The dimensions of the drone have been selected according to the regulations of the coast guard, remaining within the limits allowed to ensure that it does not need people on board and that its use is controlled. As for the drone’s capacity, it is estimated that it can hold around 6000 L of compacted plastic waste. Even if this data is not among the innovative ones, it can be considered an excellent result given the small size of the drone designed.

Finally, the effectiveness of the IdeS methodology was demonstrated, which provides all the necessary tools for the development of an innovative product.

Table 8. Top–Flop Analysis of the New Product.

	Prototype	Innovation Column
Dimensions (m)	2.4 × 1.2 × 2.0	0.9 × 0.5 × 1.8
Eco-Friendly	Symbiosis	Symbiosis
Capacity (est.)	6000 L	300,000 L
Cost	-	200
Autonomy	Fully	Fully
Recovery	Immediate	Immediate
Control	Automatic	Automatic
Consumption	Renewable energy	Renewable energy
Application	Mediterranean Sea	Ocean
Top	5	
Flop	1	
Δ	4	≥ 3

4. Conclusions

The design of a plastic recovery drone (PRD) was possible with the application of the IdeS methodology. This gave the possibility of integrating tools belonging to the best-known methodologies, such as Generative Design that demonstrated the main advantage of IDES methodology, to deliver integrated feedback across all departments included in the project development phases of a new product, from the feasibility phase until production setup. Therefore, a complete and effective approach has been obtained that can help the designer to solve rather complex design problems in base of the main product requirements. The effectiveness of the method was demonstrated through the prototyping of the drone, which represented an innovative product on the market in terms of autonomy, recovery and control. The elements of this drone were validated technically by means of CAD, CFD software.

The designed drone has, in fact, a “controlled drift” system that allows it to reach any destination independently by exploiting the motion of the tides. However, it was not

possible to obtain a drone that was autonomous in cases of strong currents. The drone was in fact equipped with two outboard motors that have significant advantages such as high silence, high economy and high performance, but which undermine the autonomy of the product. However, it is an auxiliary propulsion system to be used only in short distances.

Additionally, a compactor was chosen for waste recovery, which represents a solution with significant logistical and storage advantages and is energy-efficient thanks to the use of solar panels and, therefore, clean energy.

Furthermore, an efficient monitoring system has been devised for the control of the drone, which consists of software that can be installed on all digital devices. This software allows you to know the exact position of the drone at any time, facilitating its recovery in the event of a completed mission or for maintenance.

Author Contributions: Conceptualization, L.F., E.C. and C.L.-C.; methodology, A.L. and G.D.; software, A.L.; validation, C.L.-C.; formal analysis, L.F.; investigation, E.C., B.D.P. and U.L.; resources, L.F.; data curation; writing—original draft preparation, U.L. and C.L.-C.; writing—review and editing, C.L.-C.; visualization, C.L.-C. and M.G.; supervision, G.D.; project administration, A.L. All authors have read and agreed to the published version of the manuscript.

Funding: This research received no external funding.

Conflicts of Interest: The authors declare no conflict of interest.

References

1. Frizziero, L.; Liverani, A.; Nannini, L. Design for Six Sigma (DFSS) Applied to a New Eco-Motorbike. *Machines* **2019**, *7*, 52. [CrossRef]
2. Liverani, A.; Caligiana, G.; Frizziero, L.; Francia, D.; Donnici, G.; Dhaimini, K. Design for Six Sigma (DFSS) for additive manufacturing applied to an innovative multifunctional fan. *Int. J. Interact. Des. Manuf. (IJIDeM)* **2019**, *13*, 309–330. [CrossRef]
3. Donnici, G.; Frizziero, L.; Liverani, A.; Buscaroli, G.; Raimondo, L.; Saponaro, E.; Venditti, G. A New Car Concept Developed with Stylistic Design Engineering (SDE). *Inventions* **2020**, *5*, 30. [CrossRef]
4. Frizziero, L.; Donnici, G.; Liverani, A.; Alessandri, G.; Menozzi, G.C.; Varotti, E. Developing Innovative Crutch Using IDeS (Industrial Design Structure) Methodology. *Appl. Sci.* **2019**, *9*, 5032. [CrossRef]
5. Frizziero, L.; Liverani, A.; Coniglio, R.; Rella, A.D.; Montuschi, M.; Donnici, G. Innovative Methods like IDeS and SDE to Design a Future Family Car. In Proceedings of the 5th NA International Conference on Industrial Engineering and Operations Management, Detroit, MI, USA, 10–14 August 2020.
6. Frizziero, L.; Liverani, A.; Donnici, G.; Giuliano, I.; Picciariello, M.; Tucci, M.; Reimer, D.; Ali, A. Application of IDeS (Industrial Design Structure) to Sustainable Mobility: Case Study of an Innovative Bicycle. *Inventions* **2021**, *6*, 22. [CrossRef]
7. Butt, J. A Strategic Roadmap for the Manufacturing Industry to Implement Industry 4.0. *Designs* **2020**, *4*, 11. [CrossRef]
8. Ikumapayi, O.; Akinlabi, E.; Mwema, F.; Ogbonna, O. Six sigma versus lean manufacturing—An overview. *Mater. Today Proc.* **2020**, *26*, 3275–3281. [CrossRef]
9. Gijo, E.; Bhat, S.; Antony, J.; Park, S.H. Ten commandments for successful implementation of Design for Six Sigma. *TQM J.* **2021**. [CrossRef]
10. Qayyum, S.; Ullah, F.; Al-Turjman, F.; Mojtahedi, M. Managing smart cities through six sigma DMADICV method: A review-based conceptual framework. *Sustain. Cities Soc.* **2021**, *72*, 103022. [CrossRef]
11. Koziółek, S.; Derlukiewicz, D. Method of assessing the quality of the design process of construction equipment with the use of DFSS (design for Six Sigma). *Autom. Constr.* **2012**, *22*, 223–232. [CrossRef]
12. Sokovic, M.; Pavletic, D.; Pipan, K.K. Quality Improvement Methodologies—PDCA Cycle, RADAR Matrix, DMAIC and DFSS. *J. Achiev. Mater. Manuf. Eng.* **2010**, *43*, 476–483.
13. Daniyan, I.A.; Balogun, V.; Mpofu, K.; Omigbodun, F.T. An interactive approach towards the development of an additive manufacturing technology for railcar manufacturing. *Int. J. Interact. Des. Manuf. (IJIDeM)* **2020**, *14*, 651–666. [CrossRef]
14. da Nóbrega Costa, A.L.O.; Alves, T.C.; Frota, H.F.; Silva, A.P.D.; Júnior, M.A.P.; Dantas, R.D.F.; Martins, E.F.; Dos Santos, A.C. Development of a device for the reintegration of people with incomplete quadriplegia. *Prod. Manag. Dev.* **2020**, *18*, 145–156. [CrossRef]
15. Donnici, G.; Frizziero, L.; Liverani, A.; Aiello, S.; Marinelli, L.; Salzano, A. *Stylistic Design Engineering (Sde) Framed inside Ides (Industrial Design Structure) to Conceive a New Future Citycar*; IEOM Society: Bologna, Italy, 2021; pp. 2088–2114.
16. Donnici, G.; Frizziero, L.; Liverani, A.; Cacaci, L.; Costantini, N.; Pedrielli, G. *Ides (Industrial Design Structure) and Stylistic Design Engineering (sde) Applied to the Mobility of the Future*; IEOM Society: Bologna, Italy, 2020.
17. Briard, T.; Segonds, F.; Zamariola, N. G-DfAM: A methodological proposal of generative design for additive manufacturing in the automotive industry. *Int. J. Interact. Des. Manuf.* **2020**, *14*, 875–886. [CrossRef]

18. Marinov, M.; Amagliani, M.; Barback, T.; Flower, J.; Barley, S.; Furuta, S.; Charrot, P.; Henley, I.; Santhanam, N.; Finnigan, G.T.; et al. Generative Design Conversion to Editable and Watertight Boundary Representation. *Comput. Des.* **2019**, *115*, 194–205. [[CrossRef](#)]
19. Malka, D. A Four Green TM/Red TE Demultiplexer Based on Multi Slot-Waveguide Structures. *Materials* **2020**, *13*, 3219. [[CrossRef](#)] [[PubMed](#)]
20. Samoi, E.; Benezra, Y.; Malka, D. An ultracompact 3×1 MMI power-combiner based on Si slot-waveguide structures. *Photon Nanostruct. Fundam. Appl.* **2020**, *39*, 100780. [[CrossRef](#)]
21. Schmaltz, E.; Melvin, E.C.; Diana, Z.; Gunady, E.F.; Rittschof, D.; Somarelli, J.A.; Virdin, J.; Dunphy-Daly, M.M. Plastic pollution solutions: Emerging technologies to prevent and collect marine plastic pollution. *Environ. Int.* **2020**, *144*, 106067. [[CrossRef](#)] [[PubMed](#)]
22. Winterstetter, A.; Grodent, M.; Kini, V.; Ragaert, K.; Vrancken, K. A Review of Technological Solutions to Prevent or Reduce Marine Plastic Litter in Developing Countries. *Sustainability* **2021**, *13*, 4894. [[CrossRef](#)]
23. Caligiana, G.; Liverani, A.; Francia, D.; Frizziero, L.; Donnici, G. Integrating QFD and TRIZ for innovative design. *J. Adv. Mech. Des. Syst. Manuf.* **2017**, *11*, JAMDMS0015. [[CrossRef](#)]
24. Francia, D.; Caligiana, G.; Liverani, A.; Frizziero, L.; Donnici, G. PrinterCAD: A QFD and TRIZ integrated design solution for large size open moulding manufacturing. *Int. J. Interact. Des. Manuf.* **2018**, *12*, 81–94. [[CrossRef](#)]
25. Donnici, G.; Frizziero, L.; Liverani, A.; Galiè, G.; Lelli, F. A new SUV conceived by Stylistic Design Engineering (SDE). In Proceedings of the International Conference on Industrial Engineering and Operations Management, Bangkok, Thailand, 5–7 March 2019.
26. Frizziero, L. Tjprc Stylistic Design Engineering (SDE) for an Innovative Green Vehicle Following QFD and TRIZ Applications. *Int. J. Mech. Prod. Eng. Res. Dev.* **2019**, *9*, 805–826. [[CrossRef](#)]
27. RanMarine (s.d.). Clear Plastic and Waste with Our WasteShark ASV. *RanMarine Technology*. Available online: <https://www.ranmarine.io/products/wasteshark/> (accessed on 8 February 2021).
28. SEABIN (s.d.). Available online: http://www.oceansplasticcleanup.com/Cleaning_Up_Operations/SeaBin.htm (accessed on 8 February 2021).
29. Zaltzman, J. Boat of the Week: This 185-Foot Sea-Cleaning Sailboat Collects up to 3 Tons of Ocean Garbage per Hour. Robb Report. Available online: <https://robbreport.com/motors/marine/manta-super-sailing-vessel-eats-ocean-garbage-1234609050/> (accessed on 16 February 2021).
30. MaterialDistrict. The Ocean Cleanup: The Next Phase in Capturing Plastic (s.d.). Available online: <https://materialdistrict.com/article/ocean-cleanup-next-phase/> (accessed on 16 February 2021).
31. Poroschianu, G.C.; Haraga, G. Design of mechanical compactor for pet bottles (Analele Universităţii “Dunărea de Jos” din Galaţi. Fascicula XIV, Inginerie mecanică = Annals of “Dunarea de Jos” University of Galati). *Fascicle XIV Mech. Eng.* **2017**, *24*, 17–20. [[CrossRef](#)]
32. Islam, M.S.; Uddin, J.; AlShehri, K. Plastic Waste and Carbon Footprint Generation Due to the Consumption of Bottled Waters in Saudi Arabia. *Res. Dev. Mater. Sci.* **2018**, *5*, 1–3. [[CrossRef](#)]
33. Bacciaglia, A.; Ceruti, A.; Liverani, A. Controllable pitch propeller optimization through meta-heuristic algorithm. *Eng. Comput.* **2020**, *37*, 1–15. [[CrossRef](#)]
34. Yang, S.-H.; Kwon, D.-H.; Han, S.-K. Implementation of differentiated services in indoor visible-light communication using interchannel interference. *Opt. Commun.* **2016**, *385*, 113–117. [[CrossRef](#)]