

Alma Mater Studiorum Università di Bologna
Archivio istituzionale della ricerca

The problem of conservation of XX century architectural heritage: The fibreglass dome of the Woodpecker dance club in Milano Marittima (Italy)

This is the final peer-reviewed author's accepted manuscript (postprint) of the following publication:

Published Version:

Pizzigatti C., Franzoni E. (2021). The problem of conservation of XX century architectural heritage: The fibreglass dome of the Woodpecker dance club in Milano Marittima (Italy). JOURNAL OF BUILDING ENGINEERING, 42, 1-16 [10.1016/j.job.2021.102476].

Availability:

This version is available at: <https://hdl.handle.net/11585/835364> since: 2022-02-28

Published:

DOI: <http://doi.org/10.1016/j.job.2021.102476>

Terms of use:

Some rights reserved. The terms and conditions for the reuse of this version of the manuscript are specified in the publishing policy. For all terms of use and more information see the publisher's website.

This item was downloaded from IRIS Università di Bologna (<https://cris.unibo.it/>).
When citing, please refer to the published version.

(Article begins on next page)

The problem of conservation of XX Century architectural heritage: the fibreglass dome of the Woodpecker dance club in Milano Marittima (Italy)

Cesare Pizzigatti¹, Elisa Franzoni^{1*}

¹ Department of Civil, Chemical, Environmental and Materials Engineering (DICAM), University of Bologna, Via Terracini 28, 40131 Bologna, Italy

* Corresponding author: elisa.franzoni@unibo.it

Abstract

The present study deals with the deterioration of materials in the dome of the “Woodpecker” dance club designed by the architect Filippo Monti (1928-2015) and built in Milano Marittima (near Ravenna, Italy) in 1968. This place, considered extremely valuable due to its landscape and architectural features, has been in a state of abandonment for around 40 years, but recently the local Municipality has started a process for its restoration. The dome is made of 23 fibreglass precast rib vaults hiding a steel structure, and in early 2000s a large part of its internal surface was painted with a graffito by Blu, an internationally renowned Italian street artist.

Nowadays, both the dome and the graffito are safeguarded for their historic-architectural-artistic value by putting restrictions to their demolition and modification. However, both the dome and the graffito are affected by harsh kinds of degradation, very different from those affecting historical building materials, which endanger their state of preservation.

This study investigates whether the methodological approach of the conservative restoration can be applied to this structure, which is an example of contemporary architecture. Because of the lack of project drawings, a visual investigation was carried out to define geometric features and the most important technical details, and to deduce plausible hypotheses about building techniques that were adopted. The degradation affecting the dome and the graffito was then investigated, and samples of fibreglass, steel and paint were collected. Laboratory analyses on these samples, in addition to environmental studies concerning wind, ground water and relative humidity, were conducted to characterize the materials and identify their main deterioration processes.

A possible restoration solution in accordance with conservative restoration principles was finally proposed, showing that the application of the same methodological approach used for ancient buildings arises many challenges, due to some key peculiarities of XX century architectural heritage materials.

Keywords: FRP, polymer-composites, materials conservation, ageing, environment, steel corrosion, chloride, lichens, graffito conservation, contemporary architecture, plastic heritage.

1. Introduction

The restoration of XX century architectural heritage involves many critical aspects [1-14], including:

- the difficulty in recognizing this architecture as cultural asset worth of safeguard, because of the close historical perspective and the lack of suitable laws and regulations;
- the presence of new materials and new construction techniques inspired by an ambitious experimental approach;
- the functional, serial and temporary nature of many of these buildings (except those characterized by a declared monumental intent);
- the disagreement arising between the commonly accepted conservation principles and the need to adapt these buildings to new uses and adequate standard performances.

This issue, neglected for a long time, has raised an increasing interest in recent years, resulting presently in an intense international debate, which is generally referred to modern architecture, but can be extended also to contemporary one [1-14]. Indeed, many recent cultural initiatives have focused on the challenges of XX century heritage conservation. Primarily, the Madrid - New Delhi Document (“Approaches to the conservation of Twentieth-Century cultural heritage”) developed by the ICOMOS International Scientific Committee for Twentieth Century Heritage (ISC 20C) in 2017 [15] updating a previous version, provided a series of criteria and guidelines for the conservation and valorisation of this heritage, which is considered to be threatened by “a lack of appreciation and care”. Moreover, this Document highlighted that the XX century architecture is characterized by “new or experimental materials and construction methods”, which implies that long-term performances and durability are absolutely uncertain, thus specialists are required, especially in modern conservation technology and materials science.

Furthermore, the following initiatives are worth of note:

- the Conserving Modern Architecture Initiative (CMAI), a program promoted by the Getty Conservation Institute with the aim of investigating practical solutions for the conservation and restoration of modern architecture;
- DOCOMOMO (DOcumentation and COnservation of buildings, sites and neighbourhoods of the MODern MOvement), an international committee founded in 1988 for the promotion of modern architectural heritage, through the documentation of its most remarkable examples;
- ATRIUM (Architecture of Totalitarian Regimes of the XX Century in Europe’s Urban Memory), a European cultural route, promoted by the Council of Europe, aimed at spreading the knowledge of modern architecture of European totalitarian regimes of the XX century.

Due to the peculiarities of modern and contemporary architecture, each heritage building is often a unique case, hence a standard methodology can hardly be applied for its conservation and restoration:

a tailored and pragmatic, not general, approach is needed [3,15]. However, it is possible to identify a series of common good practices, which include:

- conducting a historical and critical investigation of the building, concerning not only the original projects, but also the construction phase [3];
- performing a geometric survey of the building, including its construction details, in order to enlighten its specific features [3];
- conducting a careful analysis about experimental materials and construction techniques which were employed, in order to provide the most appropriate conservation solutions. Indeed, this analysis allows to detect the specific deterioration processes and to suggest which skills and types of workers are necessary for the intervention [3, 15-16].

In Italy the issue of the protection and conservation of the XX century architectural heritage is particularly critical nowadays, since national laws put protective constraints upon cultural heritage only if it is more than 70 years old (50 years for outstanding buildings) and the author died [17], so the largest part of the XX century heritage is not safeguarded at all, unless a specific regulation is issued case by case.

In this context, the present paper deals with the conservation issues of a keynote contemporary structure, i.e., the Woodpecker dance club, designed by the architect Filippo Monti (1928-2015) and built in 1968 in Milano Marittima, a popular seaside town near Ravenna, Italy (Fig. 1, right). This dance club, located among the fields about 1.8 km far from the Adriatic Sea, was closed in 1975 despite its fame [18-19] and it is abandoned since then, mainly due to legal controversies between the owner of the land (i.e., the local Municipality) and the owner of the dance club (loaner for use).

The construction was conceived as a work of art at a landscape scale. In the flat plane of the surrounding fields a circular area of about 62 m diameter was dug, from which water emerged, being the level of the water table just about 50 cm below the ground level. Along the circumference, a 3 m high embankment was created, using the soil from the digging operation [19-20]. Inside this sort of crater, Monti designed an interconnected system of boardwalks suspended just above the level of the water and connected with the perimeter in few points only, giving the effect of a spider's web (Fig. 1, left) [19] and creating a series of pools. In one of these pools, a dance floor covered by an umbrella dome was built. The dome was constructed assembling on site 23 fibreglass precast rib vaults having a hidden steel structure, whose joints were externally covered with anodized aluminium profiles [19-20]. This structure, whose concrete basis was used as a dance floor, exhibits a circular hole on the top and an arched opening at the base of each vault (Fig. 2). Originally, two of these arches were the entrances to the dome, being connected to boardwalks through small metallic bridges, while the other ones were closed by glass.



Fig. 1 On the left: bird's eye view of the Woodpecker dance club, soon after its construction (courtesy of Archivio Monti [Monti's personal archive]). On the right: location of the Woodpecker dance club (red dot) with respect to Ravenna, Cervia and the Adriatic sea coast (source of the map: www.tuttocitta.it).

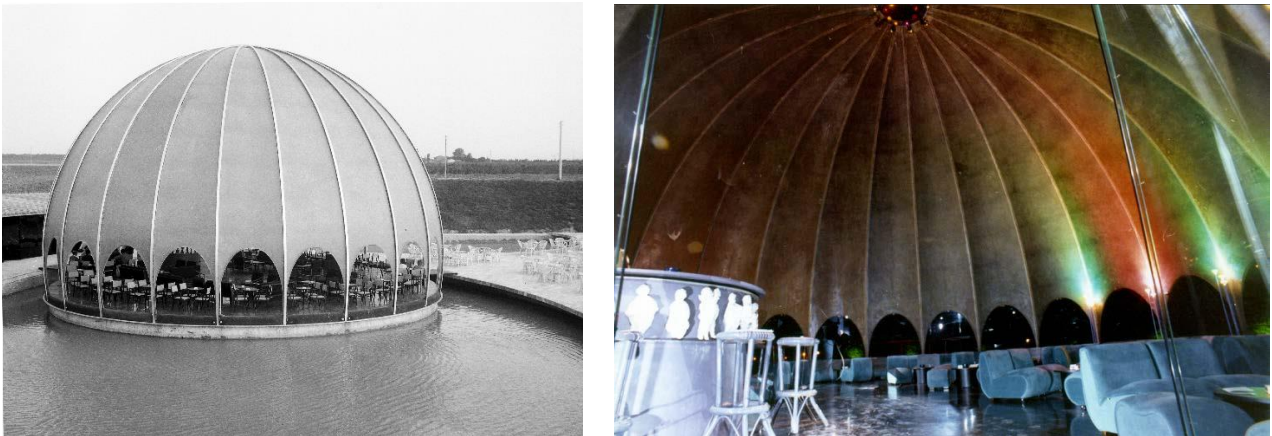

Fig. 2 Umbrella dome of the Woodpecker, when in use: outside (*left*) and inside (*right*) (left image: courtesy of Archivio Zangheri, Cesena; right image: courtesy of Archivio Monti [Monti's personal archive]).

This dome was the outcome of a highly experimental and avantgarde approach, made possible by Monti's vision and by the crafts of the firms involved in the manufacturing of the dome [19-22]. In fact, the vaults were manufactured by a local shipyard (SIPLA, specialized in racing boats), which was the only kind of factory able to build such a complex structure [20-22]. Notably, the years in which the structure was built were characterized by the introduction of fiberglass in the shipyards, a widespread industry in the Ravenna area due to the naval district related to its important port [23], and this certainly influenced the selection of fiberglass as a material for the dome construction.

The joint use of fiberglass and steel in a dome was particularly innovative. Monti, who had adopted this solution also in a previous project [19, 24-25], was probably influenced also by the plastic architecture conceived in the USA since the 1950s and/or by the previous use of this material for temporary architecture, such as exhibition pavilions, since the 1960s [26-27]. The latter hypothesis is corroborated by the fact that transience was a recurring theme in Monti's projects [19-20, 28] and

also the Woodpecker dance club seems conceived as an evanescent architecture, left to mutate and degrade in the outdoor environment, until its disappearance [19, 21-22]. This construction also exhibits all the other features of Monti's architectural vision, including minimalism (the use of essential shapes and materials) and mimetic approach (intense relationship with the landscape, influenced by *Genius loci*) [19-22, 24, 28]. An echo from Land Art, an international artistic movement arisen in that period, is also evident (e.g., see the similarities between the Woodpecker and the Observatory designed by Robert Morris a few years later) [19-20].

Several decades of abandonment compromised this place, but also provided it with a distinctive fascination, as the dome looks presently like an aerospace wreck among vegetation, covered on the whole external surface by variously coloured lichens that create an unusual illumination inside (Fig. 3).

Furthermore, in the early 2000s a huge graffito was painted on the internal surface of the dome, representing a surrealist subject. It was made with two colours only, namely black lines (probably brushed) and white backgrounds (probably made by rolls). Although no one has ever claimed its authorship, this graffito was attributed to Blu, an Italian street artist famous all over the world [21-22], as the subjects represented and the techniques adopted leave no doubts about his being the author (Fig. 4) [29-33].

In 2018, the local Municipality (Cervia), being the owner of the place since early 1980s, decided to promote its repair, by subcontracting its restoration and management. Notably, the Municipality imposed a safeguard constraint upon the Woodpecker in the city plan, due to its "historic-architectural significance" [34]. The significance and artistic value of the dance club is widely recognized also by contemporary architecture critics [19-21, 25, 35], who acknowledged the value of Monti's projects and the significance of the Woodpecker dance club in the framework of coeval artistic movements, and by citizens, associations and civil society, which periodically organize visits and public events in this suggestive place and support its conservation.

According to the constraint imposed by the Municipality, the dome and the surrounding area must be repaired and conserved and the original use must be kept, possibly also adding new cultural and entertainment activities. In particular, a scientific conservation is requested for the dome. It should be noted that the council urban planning tools were the most effective way to safeguard this place, since this construction is less than 70 years old and hence it is not covered by ordinary protection regulations according to Italian laws. Moreover, the Municipality imposed a protective restriction also upon the graffito, requiring its conservation.



Fig. 3 Current state of the Woodpecker dance club, invaded by vegetation (the photo was taken through the drone described in § 3.1).



Fig. 4 Graffiti by Blu inside the dome.

2. Research aim

In this paper, the issues of deterioration and conservation of the materials of the Woodpecker dome (fiberglass, steel and graffiti paints) were investigated, while the calculation and verification of the structure according to current regulations was not carried out, as it was considered beyond the scope of the present paper. It is noteworthy that a multi-material approach is very often necessary for the restoration of modern and contemporary buildings, which were frequently conceived like machines made of different components, each of them constituted by a specific material designed for a very distinctive function, and where even the colour plays a key role [36, 37].

While the durability of fiberglass composite materials used for seismic reinforcements of buildings has been discussed in many literature papers (e.g., [38-40]), the long-term behaviour and deterioration of outdoor-exposed fiberglass structures, such as sculptures [41] and other types of artworks [42-43] or domes in contemporary churches [44], is scarcely addressed in the literature, hence it deserves investigation.

Conversely, many literature studies concern the problem of conservation and restoration of steel frameworks in XX century architectural heritage. In fact, this material was extensively used not only in structures and buildings (bridges, glass and steel roofs of arcades, industrial buildings, etc.), but also for reinforced concrete [45]. The preservation of original material is to be pursued, when possible, carrying out local repairs and cleaning of the elements and then protecting them by coatings or cathodic protection [46-48]. However, replacement is allowed for the elements affected by an irreversible state of deterioration, paying attention to the compatibility between new and original materials [46,48-49]. Modelling may also be a useful tool in predicting the corrosion process and identifying the structural behaviour, which could help in adopting the right solutions for the conservation and the future maintenance [46, 49].

In this study, the methodological approach currently used for ancient heritage building conservation was followed. In particular, a holistic approach was adopted [50]:

- a preliminary analysis of the dome was carried out, including its geometrical survey and the investigation of the construction technologies (as no project drawings are available), as well as the mapping of the deterioration patterns;
- an analysis of the environmental surroundings was carried out, by collecting the climatic data and performing some chemical analyses of the water in the ‘crater’;
- materials characterization was carried out, by collecting samples of unweathered and deteriorated materials and applying different analytic techniques;
- some guidelines for the conservations of the dome were proposed and discussed.

The results showed that the application of the approach currently adopted for heritage buildings conservation is possible, but the conservation itself arises serious problems. First of all, there is a marked disagreement between the concept of safeguard and the transient nature of both the dome and the graffiti: indeed, evanescence was a main characteristic of this work of art by Monti and temporariness is a typical feature of street art [33, 51-54]. Moreover, the experimental and innovative nature of the materials used in the dome, namely fibreglass vaults with a steel frame, arises several problems of durability in the outdoor environment. Finally, it is noteworthy that current literature is lacking about the long-term performance of fibreglass for constructions exposed to aggressive environments and about the deterioration and conservation of this material in architecture.

3. Materials and methods

3.1 Geometric and visual survey, analysis of the construction technology

No project drawings are presently available, as they were not stored in the Municipality of Cervia's archive and they were not found in Monti's office, given the lack of a historic archive accessible for consultation. Moreover, the shipyard that manufactured the fibreglass vaults was acquired by a different enterprise (Comar Yachts, Rome) in 1998 and the original documents of the project are no more available.

Hence, a geometric survey of the dome was carried out in this study. A careful visual observation was performed, also by means of a drone (DJI Phantom 3.12 Mpix, controlled from close distance, not equipped with tools for geometric 3D reconstructions, hence employed only for acquiring photos and videos), in order to investigate the construction technology of the dome, also exploiting zones with defects and ruptures that allowed to see the hidden details. Moreover, a mapping of the deterioration pattern and the conservation state of the materials was carried out.

3.2 Analysis of the environment

Environmental data in this location, including temperature, relative humidity, speed of the wind and its direction were collected from ARPAE ER (Agenzia Regionale per la Prevenzione, l'Ambiente e l'Energia dell'Emilia-Romagna). These data refer to a 5×5 km² mesh that covers the entire regional territory. The Woodpecker is inside the cell labelled with code number 02065 and named "Lido di Classe" (Longitude: 12.349075; Latitude: 44.3175). Each cell is characterized by the following data:

- as far as temperature is concerned, the maximum and minimum daily temperature were collected for the period 1961-2015, interpolating values measured by permanent weather stations. Starting from these data, average monthly values were calculated for the cell No. 02065;
- as far as relative humidity is concerned, the maximum, minimum and average daily relative humidity values were collected for the period 2001-2016, provided by the ERG5 dataset and calculated using real-time data measured by stations. Starting from these data, average monthly values were obtained for the cell No. 02065;
- as far as wind is concerned, the average daily speed of the wind and its prevalent daily direction were collected for the period 2001-2016, provided by the ERG5 dataset and calculated using real-time data measured by stations. Starting from these data, the overall and seasonal wind roses were determined and drawn for the cell No. 02065, also separately considering the winds that occurred in presence of rain.

Since the groundwater floods the floor during the rainiest periods (spanning from late autumn to early spring), the immersed portion of the dome is subject to a particularly aggressive environment. Thus, with the aim of characterizing this water, three samples were collected from three different locations

of the basins during two surveys conducted in the spring season: A1, collected in March 2018; B1 and B2, collected in April 2018. The type and the amount of salts in the water were determined by ion chromatography analysis in a Dionex ICS-1000.

3.3 Samples

Samples of fibreglass, steel, white paint and black paint were collected from different locations in the dome and they are reported in Table 1.

| Sample | Description | Sampling location |
|--------|---|---|
| S1 | Completely rusty steel flakes, characterized by a porous aspect and low strength. They were manually detached | Steel arch of the dome, zone immersed in water during rainy periods |
| S2 | Completely rusty steel flake, characterized by a solid aspect and high strength. It was manually detached | Steel arch of the dome, approximately 1 m above the floor, thus most likely never reached by ground water |
| S3 | Small resin fragment without fibres, apparently not affected by degradation. It was collected by means of a hacksaw | Intrados of a fibreglass vault, 1.30 m above the floor |
| S4 | Deteriorated fibreglass sample, with the external surface affected by erosion of the matrix, with emerging fibres and presence of lichens. It was manually detached | Fibreglass layer coating the steel framework on the extrados, approximately 0.70 m above the floor |
| S5 | Deteriorated fibreglass sample, with the external surface affected by erosion of the matrix, with emerging fibres and presence of lichens. It was manually detached | Fibreglass layer coating the steel framework on the extrados, approximately 0.30 m above the floor |
| S6 | Deteriorated fibreglass fragments, almost completely lacking in resin, hence characterized by exposed fibres covered by lichens in many points. They were manually detached | Fibreglass layer coating the steel framework on the extrados, approximately 0.70 m above the floor |
| S7 | Fibreglass fragments affected by swelling in some points and characterized by a solid aspect and fibres partially emerged. They were detached by means of a hacksaw | Intrados of a fibreglass vault, at the edge of a hole, 2.30 m above the floor |
| S8 | Flakes of white paint in a good state seemingly. They were collected by means of a cutter | White paint of the graffito, approximately 1.40 m above the floor |
| S9 | Flakes of black paint in a good state seemingly, with a white substrate. They were collected by means of a cutter | Black paint of the graffito, approximately 1.60 m above the floor |
| S10 | Flakes of white paint, affected by a marked deterioration characterized by a green patina and a dramatic weakness. They were collected by means of a cutter | White paint of the graffito, approximately 0.80 m above the floor |
| S11 | Flakes of white paint, covered by a green patina. They were collected by means of a cutter | White paint of the graffito, approximately 2.80 m above the floor |
| S12 | Dark soiling covering the white paint of the graffito. It was collected by scraping | White paint of the graffito, approximately 2 m above the floor |
| S13 | Dark soiling covering the white paint of the graffito. It was collected by scraping | White paint of the graffito, approximately 2.20 m above the floor |

Table 1 Samples collected from the dome.

3.4 Materials characterization techniques

The nature of the resin matrix of the fibreglass was investigated by Fourier-Transform Infrared Spectroscopy (FT-IR), in a PerkinElmer Spectrum Two spectrometer equipped with a diamond crystal in attenuated total reflectance (ATR) mode. The test was performed on sample S3, considered representative of the composite matrix, due to its good state of conservation and the lack of fibres. The resin fragment was put directly in contact with the crystal. The measurement was conducted in the range of 4000 to 400 cm^{-1} at room temperature, the spectral resolution was 4 cm^{-1} and the number of scans was 32. Spectral data were processed with Spectrum 10 software (PerkinElmer).

An Olympus SZX10 stereo-optical microscope (SOM) was used for the following analyses:

- observation of the external surface of the fibreglass sample S4, to investigate the deterioration of the matrix and its biological decay (due to lichens);
- examination of the cross section of the fibreglass sample S7, to investigate the nature of the decay;
- observation of the external surface of the white and black paint samples, S8 and S9 respectively, to investigate their morphology;
- observation of the green patina on the surface of the white paint sample S10 and observation of the powder samples S12 and S13, to investigate their nature.

A Philips XL20 SEM scanning electron microscope (SEM) equipped with EDS microanalysis was used for the following analyses:

- the external surfaces of the fibreglass samples S4 and S5 were observed in order to investigate the deterioration of the matrix, the arrangement of the fibres, as well as the heterogeneity of fibreglass phases and the fibreglass production process;
- the surface of the steel samples S1 and S2 was studied by an EDS analysis to identify its nature (carbon steel or stainless steel);
- some fibres removed from the fibreglass sample S6 were observed in order to investigate the presence of micro-cracks; moreover, an EDS analysis was conducted on these fibres;
- the external surfaces of the white and black paint samples, S8 and S9 respectively, were observed in order to compare their morphology; EDS analysis was conducted on both;
- the green patina that covers the surface of the white paint samples S10 and S11 was observed in order to study its nature and EDS analysis was conducted too.

Each sample examined via SEM had been previously made conductive by applying an aluminium coating.

4. Results and discussion

4.1 Geometric and visual survey, analysis of the construction technology

The geometric survey of the dome allowed to highlight the following main aspects:

- it is a sphere of 8.20 m radius, sectioned 1.40 m below the horizontal diametral plane (Fig. 5);
- each vault has a sort of impluvium in the middle, which gradually increases from the top, where it is absent, to the bottom (Fig. 5).

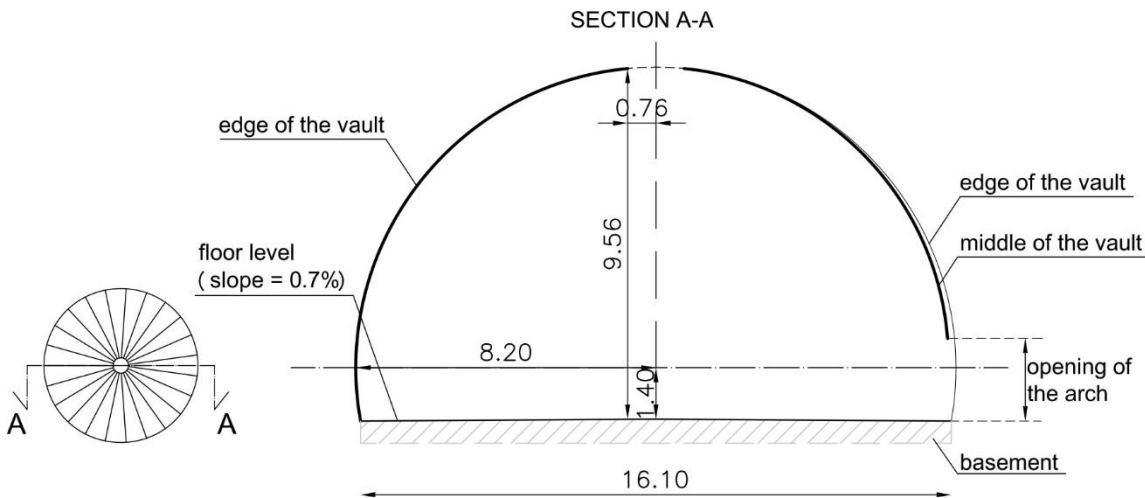

Fig. 5 Schematic representation of the cross section of the dome, drawn after a geometric investigation on site (sizes in m).

The visual investigation allowed to disclose the most important technical details, which are reported in Figures 6-7. In particular, it was possible to make the following observations:

- the basement is a circular reinforced concrete slab, with a cantilever edge covered by a steel ring having a L-shaped cross section. This element, now completely rusted, was originally hidden under a mortar layer (Fig. 6), now mostly detached;
- the vaults' ribs are tubular steel arches with a rectangular-shaped cross section ($9 \times 3 \text{ cm}^2$). It was not possible to measure the exact thickness of the steel, as the low part of the dome, where the fiberglass is no more present due to deterioration, exhibits a marked corrosion, and it was not possible to carry out destructive survey on the upper part. However, the thickness was estimated to be about 5 mm, by observing the corroded parts. The steel arches lie on the extrados of the fiberglass dome, along the borders of each vault (extreme meridians of the cut sphere), and they are coated by a fiberglass layer. Therefore, every arch of the framework is constituted by the combination of two tubular elements put side by side and their joint is covered on the outer surface of the dome by a U-shaped anodized aluminium profile;
- at the bottom, each tubular steel arch is fixed to an attachment plate, having the same width

of the tubular section and a thickness of ~1 cm. This plate is yielded to the steel ring described above. At the top, each tubular steel arch is fixed to a central steel ring, consisting in a double-T beam about 15 cm high, which constitutes the edge of the circular hole of the dome. In both cases, bolted connections were used (Fig. 7);

- the thickness of the fibreglass vaults is about 1 cm.

Considering all these features, the whole dome seems to be characterized by a very light weight, which can be estimated approximately 13 tons. The presence of the lichens could significantly affect this estimate, especially when they are moist due to the surrounding environment (see Section 4.2), but it is very difficult to calculate their specific contribution in terms of overall weight increase.

Based on the information collected, it was possible to put together the building techniques that were adopted.

- The vaults were manufactured by a handmade lay-up process and the fibres are in the form of mat (short fibres randomly arranged), representing the most common solution employed at the age of construction for the fabrication of such elements [27, 55-57]. A mould was used at the internal surface, which is in fact smooth.
- The steel arches were embedded into the fibreglass through a manufacturing process named overlamination (Fig. 8) [26].
- Each single vault with two steel arches embedded along the main borders was manufactured at the shipyard, then transported to the construction site and assembled (see also the following issue).
- Each couple of flanked tubular steel arches was cross bolted, the bolts being hidden inside the tubes. As the joining of the arches was made on site, bolts, whose diameter seems approximately 10-15 mm (it was not possible to determine the exact value, for the reasons explained above), were supposedly inserted by drilling through the fibreglass coating and the steel elements, finally the holes were covered with fibreglass patches. This assembling system can now be observed in few points, where the deterioration of fibreglass makes the holes visible. The distance between adjacent bolts can be deduced from local dips or swellings in the fibreglass along the ribs (Fig. 9) and resulted equal to about 1 m.

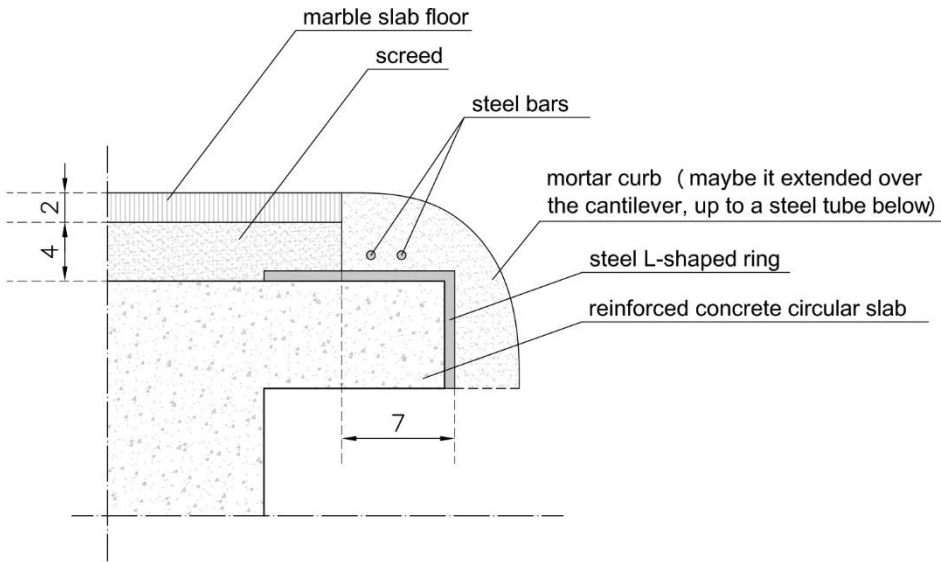
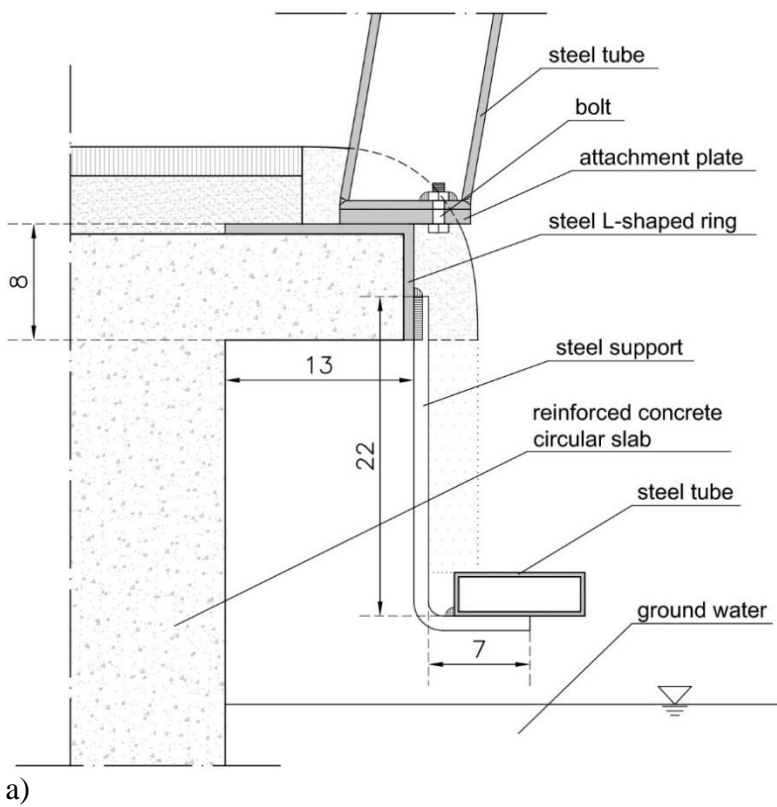

Fig. 6 Edge of the basement: the cross section in correspondence of an opening of the dome, as inferred by the investigation on site (sizes in cm).



b)



c)

Fig. 7 Attachment of the steel framework to the concrete base (*a*, *c*) and to the steel ring on the top (*b*). The detail of the cross section in correspondence of a tubular steel arch in *a*) (sizes in cm) was inferred by the investigation on site. The role of the hollow rectangular steel tube below is not clear: it was likely designed to support the mortar curb, which probably extended below the cantilever originally.

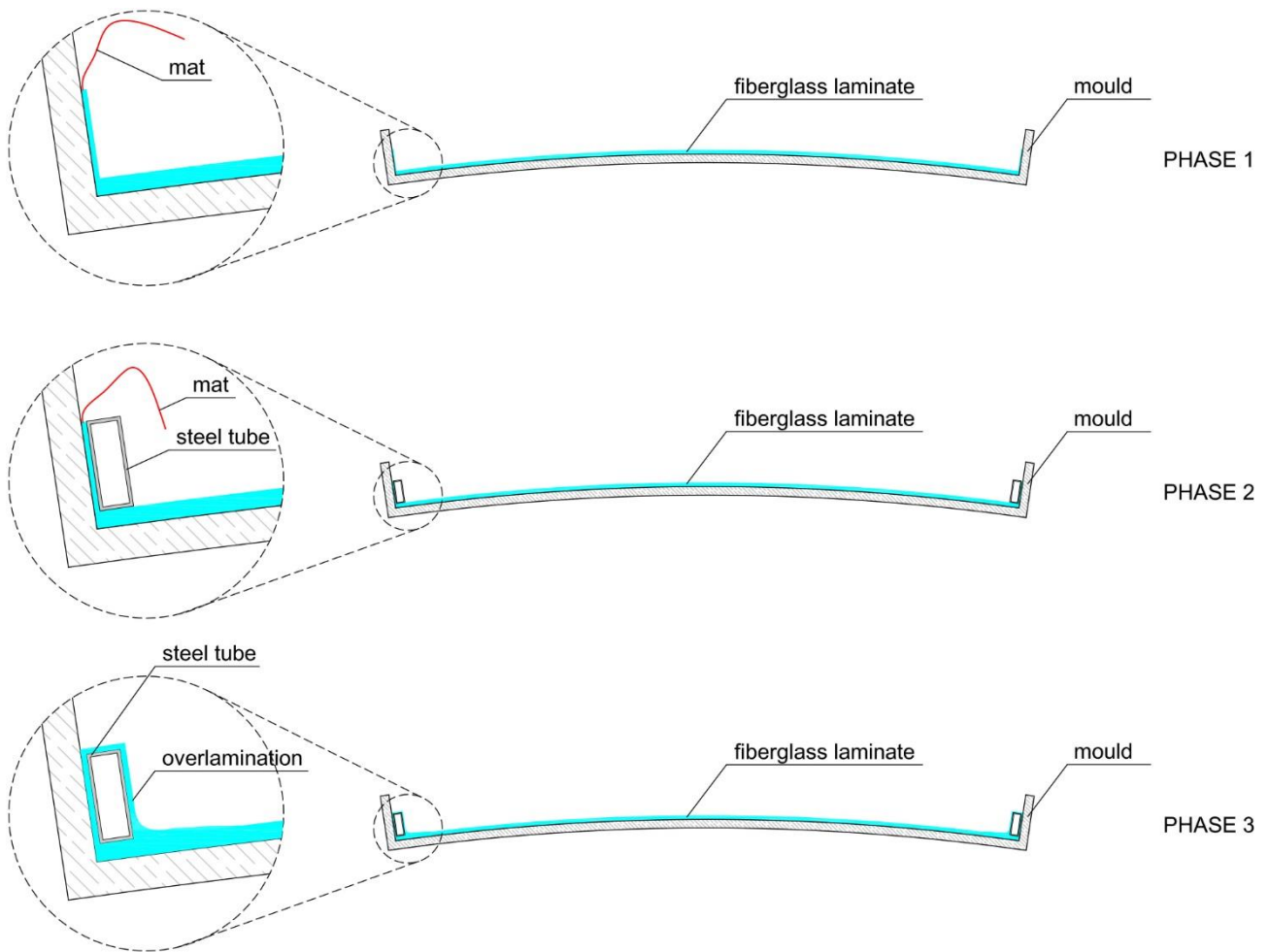

Fig. 8 Schematic illustration of the process of overlamination.

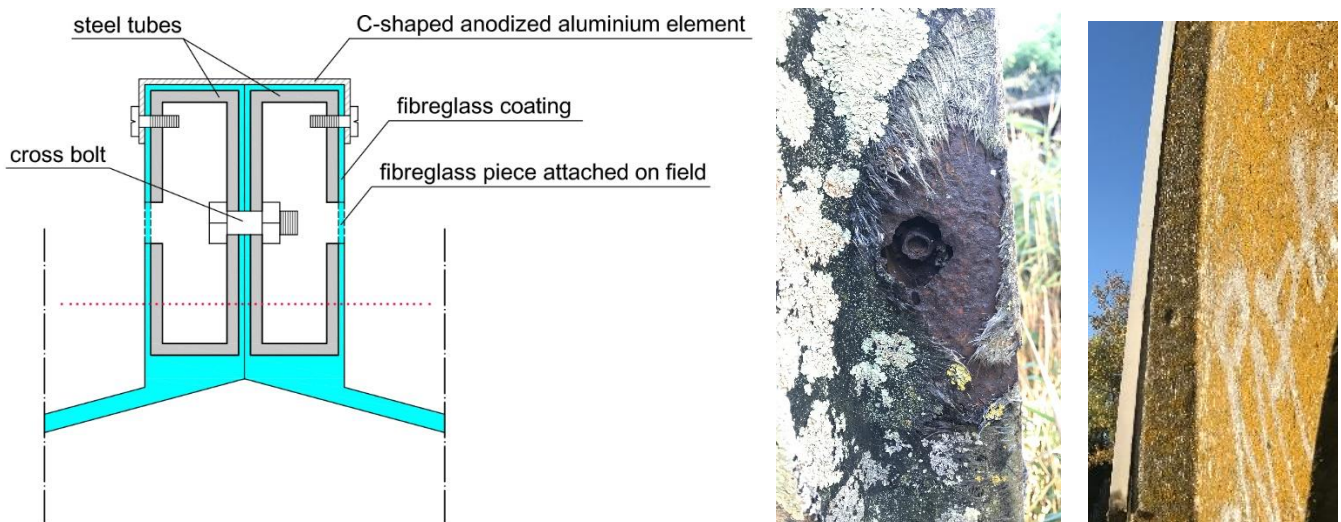

Fig. 9 Join of flanked tubes: the cross section (*left*) and some photos (*centre* and *right*). The dotted red line indicates where the vaults could be cut for the repair intervention, as explained in Section 5. The bad conservation state of fibreglass, which is lacking in some points and is affected by dips or swellings in other points, allowed this joining system to be identified. On the right, it is also possible to observe the C-shaped anodized aluminium element still in place in the upper part of the dome.

Concerning the deterioration of the dome and the graffito, the main critical issues detected during the survey are summarised in the following.

- On the external surface of the dome, the mat is exposed and almost bare, so the surface is rough and entirely covered by different lichen species. They are characterized by specific colours and morphologies, depending on the orientation of the surface where they grew (Fig. 10): green-brown lichens are mostly located in the S-W, W and E zones; white lichens are exclusively located in N-W, N and N-E zones; dark brown lichens are mostly located in N-W, N and N-E zones; orange-red lichens are almost exclusively located in E, S-E and S zones.
- The fibreglass layer that originally wrapped the steel framework is currently totally or partially absent in the low, periodically immersed, zone, due to deterioration. In some cases, the edge is sharp, while in other cases it is frayed due to the matrix decay. This kind of decay probably started in correspondence of the cross bolts (Fig. 11a).
- The tubular steel profiles exhibit an impressive corrosion at the bottom, where, in addition to the lack of the fibreglass layer, they are immersed in ground water for some months a year (Fig. 11c). In some locations, they are in such bad conditions that it is possible to manually remove corroded flakes and entire portions of them are even lacking near the joints to the basement (Fig. 11b). Although the steel elements are not visible in the upper part of the dome, corrosion probably affects the whole metallic framework, as suggested by the presence of some rust leakages in the internal surface of the dome, along the joints between vaults.
- In some areas of the dome intrados, fibres emerge, having the appearance of a scratched surface or of crust on the fibreglass, depending on the level of deterioration (Fig. 12a). Several local bulges can be observed too, similar to small craters surrounded by radial hair cracks. In some of these bulges the inner layers are exposed to the environment (Fig. 12b).
- The graffiti by Blu is affected by several deterioration patterns. In the lowest zone it was vandalized by many writings. Up to about 2 meters in height, the paint tends to peel very easily, especially in correspondence of the vandal writings, while in other zones the paint tends to pulverize diffusely. In particular, the spray-painting used for the vandal writings seems directly responsible for the deterioration of the graffiti, due to the incompatibility of the two overlapped layers. Indeed, the organic solvents employed in the spray paint dissolved the polymeric binder of the graffiti underneath. Moreover, the fast drying of the writings usually involves a strong shrinkage that breaks the underlying weak paint of the graffiti. In the northern vaults the white paint is widely covered by a green patina (Fig. 13a), while in the southern ones there are dark and blurred stains, which seem to be not simply due to the dissolution of black outlines of the graffiti, since they are still sharp (Fig. 13b).

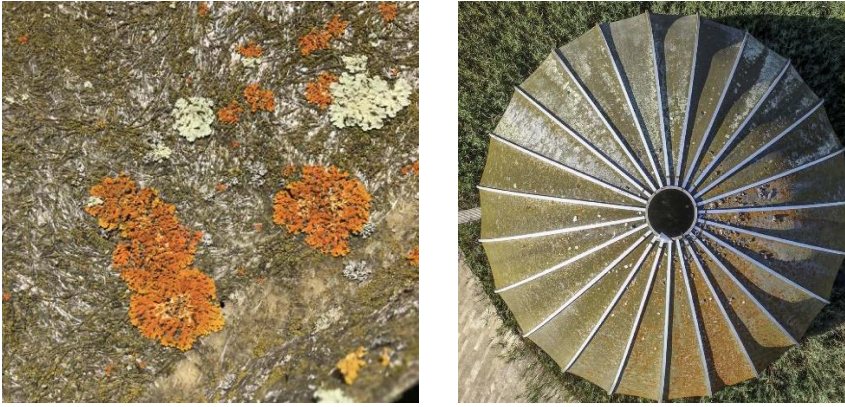

Fig. 10 Lichens on the external surface of the dome. On the left: emerging mat and differences between lichens. On the right: north-oriented zenith view of the dome, where lichens of different colours depending on the orientation can be seen (the photo was taken through the drone described in § 3.1).



Fig. 11 a) Deterioration of the fibreglass layer that initially wrapped metallic tubes; b) corrosion of metallic framework near the base (two joined flanked tubes and their connection to the basement can be seen); c) rising of the level of ground water during the rainiest periods (courtesy of Antonello Zoffoli).

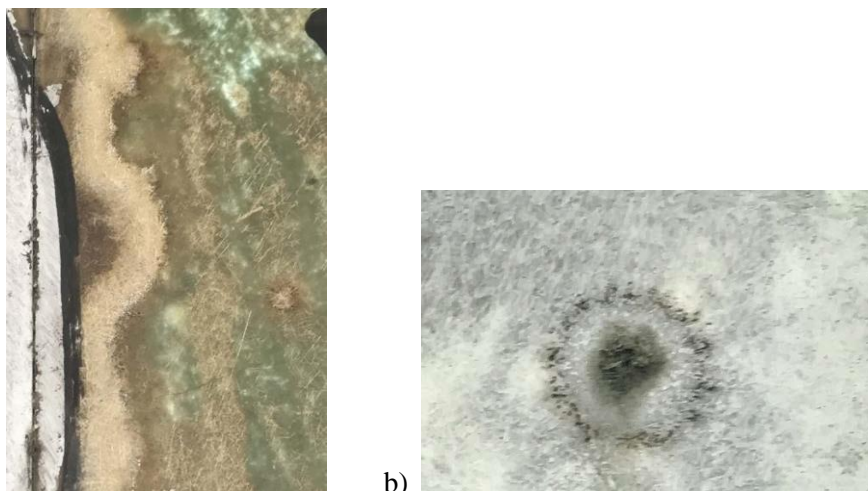

Fig. 12 a) Fibers emerging from fibreglass inside the dome; b) local bulge on the internal surface of the dome.



Fig. 13 a) Green patina covering the white paint in the northern vaults; b) dark stains on the paint in the southern vaults (the pulverization of the white paint can be noticed).

4.2 Analysis of the environment

A very low concentration of sulphates and a very high concentration of chlorides were found in all water samples, as shown in Table 2, where the concentration of the same anions in the tap water in the close city of Ravenna is reported, for comparison's sake. From these results, the ground water appears very brackish, which surely contributed to the corrosion of the steel framework in the lowest part, immersed in water for some months a year.

| Sample | Chlorides (Cl ⁻) [ppm] | Sulphates (SO ₄ ⁻²) [ppm] |
|--------------------------------|------------------------------------|--|
| A1 | 235 | 49 |
| B1 | 598 | 78 |
| B2 | 592 | 71 |
| Tap water in Ravenna city [58] | 35 | 51 |

Table 2 Concentration of chlorides and sulphates in three samples of ground water collected on site (A1, B1, B2) and in the tap water in Ravenna.

The following significant results were obtained by studying the environmental data collected from ARPAE ER:

- The average maximum monthly temperature is above 25°C during all summer, i.e. from June to September, and around 30°C in July and August (Fig. 14). These conditions are certainly very aggressive for polymeric materials, as they boost temperature-related ageing processes for some months a year, especially considering that the dome is not sheltered at all by other constructions, being exposed to direct sun radiation from sunrise to twilight. Moreover, the minimum monthly temperature is less than 0°C in January and February (Fig. 14), hence possibly causing freeze-thaw cycles in those materials that exhibit micro-cracks.
- The average maximum monthly relative humidity is extremely high, namely about 90%, all over

the year and the average monthly relative humidity remains above 80% during autumn and winter, i.e. from October to February (Fig. 15). This means that the dome is exposed to a very high air relative humidity for most of the year and this is a detrimental condition for the deterioration of the polymeric matrix, as moisture accelerates all the ageing phenomena.

- Cold winds (autumn and winter) and rainy winds (i.e., winds corresponding to those days in which rain was registered) mostly come from the western side (Fig. 16). Conversely, the winds with highest speed mostly come from N-E. As the lichens on the dome are characterized by different morphology and colour, there seems to be a correlation between the distribution of the different lichens and the environmental context. The comparison between the dome extrados (Fig. 10, right) and the analysis of winds (Fig. 16) showed that orange-red lichens preferentially grew in an area more sheltered from cold winds, blowing in autumn and winter, but quite frequently exposed to rainy winds.

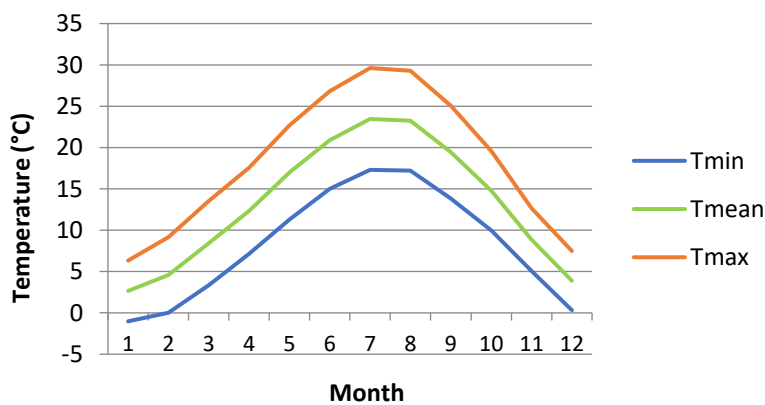

Fig. 14 Mean monthly temperatures during the year.

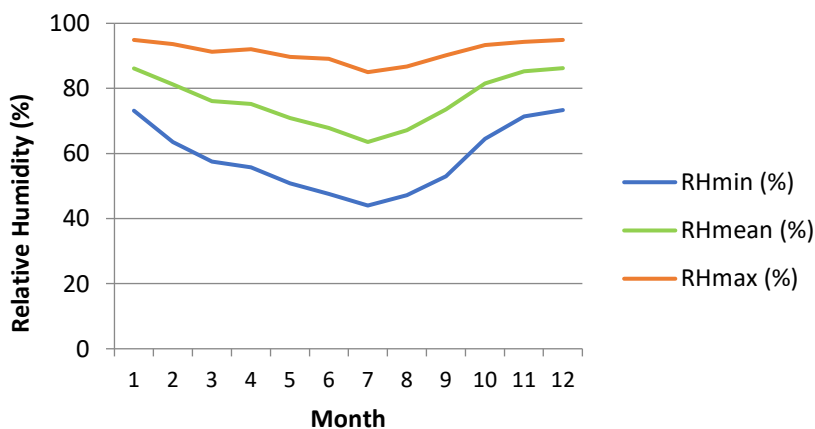

Fig. 15 Mean monthly relative humidity values during the year.

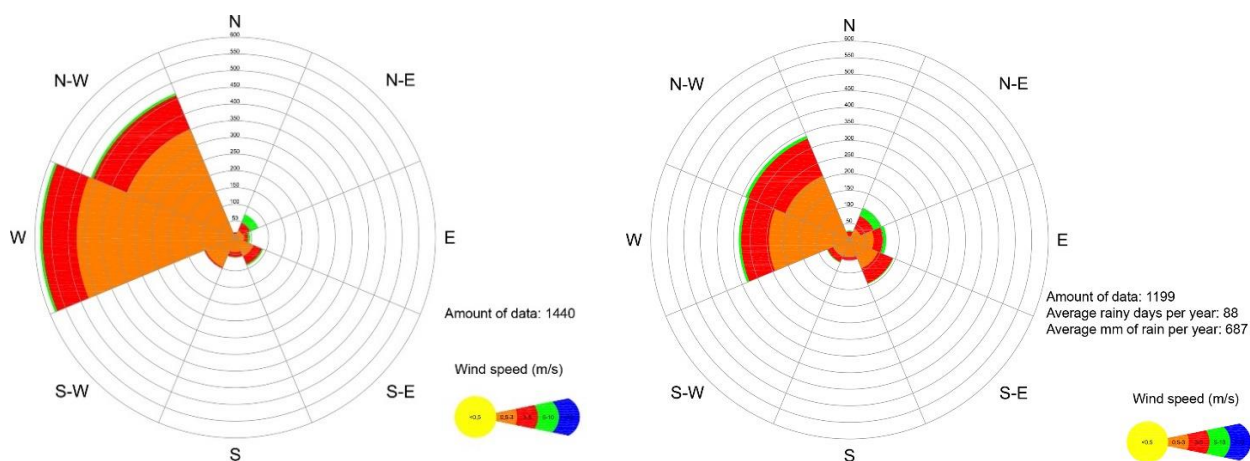

Fig. 16 Winter winds (*left*) and rainy winds (*right*).

4.3 Materials characterization

The FT-IR spectrum allowed the matrix to be identified as an unsaturated polyester resin (Fig. 17), which was the most widespread matrix in the production of fibreglass elements when the Woodpecker was built, due to its easy workability and a good performance to cost ratio [27, 55-57, 59-60]. The absorption bands were attributed as in the following:

- broad band $3600-3000\text{ cm}^{-1}$, centred at 3287 cm^{-1} : stretching of hydroxyl groups (OH) (the broadness is due to the intermolecular hydrogen bond) [60-63];
- 2918 cm^{-1} and 2850 cm^{-1} : asymmetric and symmetric stretching of the methylene groups (CH_2) respectively [61-63, 65, 68, 70];
- 1724 cm^{-1} : carbonyl ($\text{C}=\text{O}$) stretching (ester group) [60-70];
- 1633 cm^{-1} and 1542 cm^{-1} : vibration of styrene [64];
- 1580 cm^{-1} and 1493 cm^{-1} : $\text{C}=\text{C}$ stretching of aromatic ring [60, 62-65];
- 1452 cm^{-1} and 1378 cm^{-1} : asymmetric and symmetric bending of the methyl groups (CH_3) respectively [62-63, 65, 70];
- 743 cm^{-1} and 699 cm^{-1} : $\text{C}-\text{H}$ out-of-plane bending of aromatic ring [60-65, 69-70].

The bands at 1255 cm^{-1} and 1026 cm^{-1} are probably due to $\text{C}-\text{C}(=\text{O})-\text{O}$ and $\text{O}-\text{C}-\text{C}$ stretching vibrations, although they are slightly shifted compared to their usual positions [60-66, 69-70].

The absence of bands at about 985 cm^{-1} (polyester $\text{C}=\text{C}$ vibration) and 910 cm^{-1} (styrene $\text{C}=\text{C}$ vibration) indicates that the reticulation process was complete [66-67], consistently with the controlled procedure of manufacturing of the fiberglass in the shipyard.

The EDS analysis conducted on the steel samples S1 and S2 (not reported here for brevity sake) revealed no chromium and indicated that carbon steel was used for the structure of the dome rather than stainless steel, thus neglecting the aggressive environmental conditions of the site.

SEM images showed that the resin wrapping the fibres is not present anymore in many zones (Fig. 18, left). This erosion was mainly ascribed to the ageing of the polymer, likely due to hydrolysis, which consists in polymer bonds breaking due to prolonged exposure to water [57, 59, 66]. In the Woodpecker dome, this kind of degradation was exacerbated by the environmental conditions (see Section 4.2), involving a very high relative humidity all over the year, also combined with high precipitation during winter and high temperature during the summer season, which favoured hydrolysis. The direct and unsheltered exposure to solar radiation (and hence UV) and the presence of surrounding vegetation (providing O₂) likely boosted the ageing of the resin. Once the resin layer started to deteriorate, the occurrence of freeze-thaw cycles and the presence of lichens keeping the surface moist for long time seem to have intensified the deterioration processes [57, 60, 68-71]. The arrangement of fibres, which is visible due to the lack of the matrix, confirmed that they are in the form of mat, as per preliminary hypothesis (Fig. 18, centre). The SEM image of the surface of a deteriorated fibreglass sample (Fig. 18, right) highlights the presence of a series of layers of matrix and mat, confirming that the vaults were manufactured by a hand layup process (see Section 4.1). Observing the fibres by SEM, no hair cracks were found (Fig. 19, left), despite the aggressiveness of environment where the dome is located, probably also thanks to the presence of the original protective coating (sizing) over the glass fibres [26-27, 55-56, 59]. The EDS analysis performed on a portion of the fibre surface not covered by the resin anymore (Fig. 19, centre) allowed to detect the presence of calcium (Ca) and the absence of sodium (Na) and potassium (K) (Fig. 19, right). Based on this, the mat was probably constituted by E-glass fibres [55-56], the most widespread type of fibres used in the production of fibreglass elements when the Woodpecker was built. Indeed, their low cost combined with good physical-chemical properties made these fibres attractive for several applications [26-27, 55-56, 59].

In Figs. 20a-b some significant SOM images of cross sections of a fibreglass sample are reported. A marked delamination, i.e., the separation of resin and mat layers, can be observed. This type of deterioration is detrimental, as it hinders a correct stress transmission within the composite material and compromises its mechanical performance. This loss of adhesion between the matrix and the reinforcement may be due to the breaking of strong bonds formed during reticulation process between the polymer matrix and the fibres sizing [26, 55, 59]. This deterioration can be accelerated by the presence of moisture at the interface, and by microbial decomposition of the sizing chemicals [55-56, 59, 66, 69, 72], although in this study no specific investigation on the nature of the adhesion mechanism (chemical or physical) and sizing was conducted.

In Figs. 20c-d, SOM images of the external surface of the fibreglass of the dome are reported. The fibre mat, which emerged due to the resin decay, became an optimum rough base for the growth of

various species of lichens, which actually cover most of the surface. These lichens probably caused an additional loss of resin, due to their metabolic processes. This biodeterioration includes a series of chemical and physical-mechanical actions onto the polymeric substrate, such as the leaching of some chemical compounds (fragments of polymeric chains, as well as additives) used as nutrients, the secretion of aggressive substances (e.g., acids and enzymes), the penetration and growth by hyphae, and the blistering due to gas evolution [57, 72-78].

The materials of the graffito were characterized too. The surface of the white paint, observed by SOM, exhibited many pits and crevices (Fig. 21a) and the same paint, observed by SEM (Fig. 21b, sample on the right), revealed a microporous nature, which suggests that water was used as medium and the organic binder in the paint was in a low amount. Hence, it was concluded that Blu used a water-based paint [79] (tempera paint, probably), and the pits and crevices probably resulted from the evaporation of water and the shrinkage of the binder, respectively. The EDS analysis performed on the same sample (not reported here for brevity sake) supported this conclusion, as calcium, oxygen, carbon and silicon were the main elements found, together with a minor amount of titanium. This is compatible with the presence of an organic binder in the paint, with calcite and quartz as fillers and TiO_2 as white pigment, the latter being typically used in water-based paints [80-81]. Given its nature, this paint can be expected to be not so compatible in terms of adhesion with the smooth and non-porous fibreglass substrate, and this certainly jeopardized the durability of the graffito. Moreover, tempera paint is water-sensitive and hence vulnerable to dry-wet cycles of moisture condensation, likely caused by the high relative humidity of the environment (see Section 4.2). The low adhesion to the substrate and the water-sensitivity of the paint caused the powdering phenomenon observed [82]. Notably, in the years when the graffito was painted, Blu was reported to change his painting technique from spray to brushing [29], and this can be ascribed to the use of water-based paints.

The surface of the black paint, observed by SOM and SEM, exhibited a more compact and homogeneous aspect than the white one (Fig. 21b, sample on the left), also because in the sample observed the black layer was applied onto the white paint. According to EDS analysis, the black paint is similar in nature to the white one, but obviously different for the pigment, as confirmed by the presence of iron (Fe) instead of titanium (Ti) [81, 83].

The SOM images of the green deposit over the white paint (Fig. 21c) and even more the SEM analysis (Fig. 21d) showed that this deposit is composed of microorganisms, which could be classified as algae, again connected to the possible moisture condensation occurring in north orientation. The almost exclusive presence of C and O found by EDS in this samples confirmed the biological nature of the patina. Also the solid dark brown powder found on the paint appears as a biological deposit, as shown by SOM images (Figs. 21e-f). Further investigations are running to characterize both deposits

more in detail.

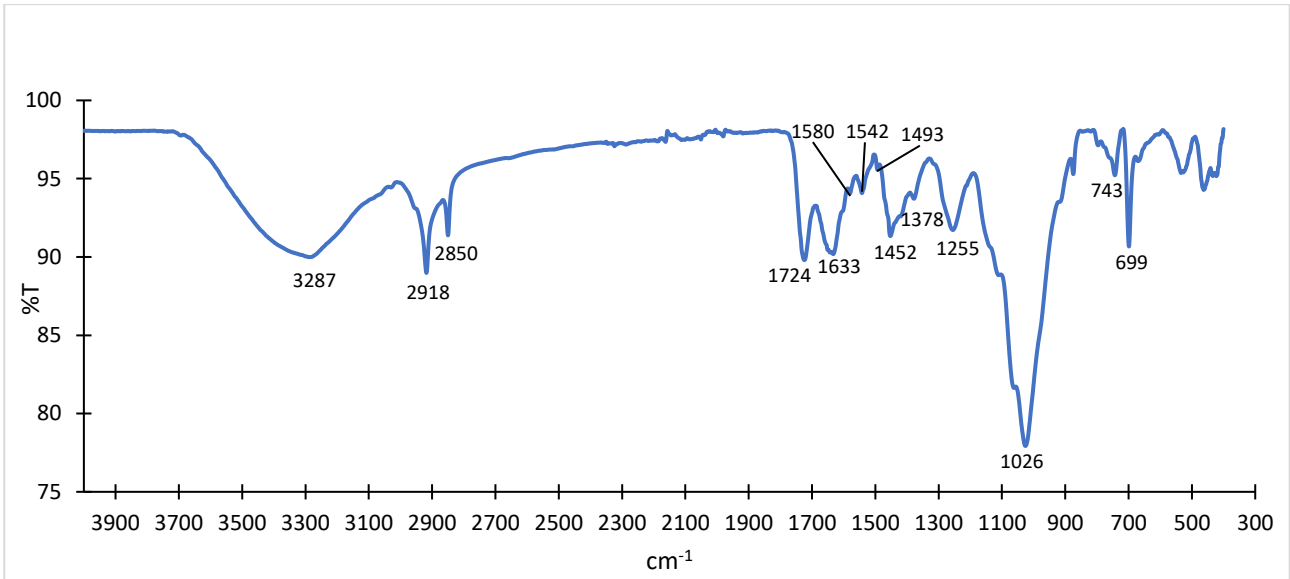

Fig. 17 FT-IR spectrum of the resin sample S3.

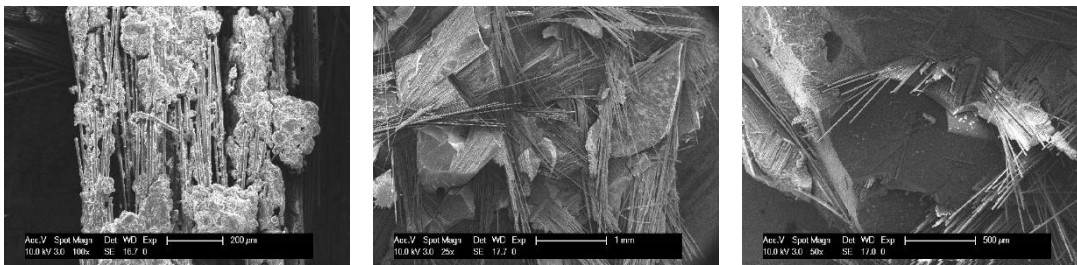

Fig. 18 Fibreglass samples. On the left: SEM image of sample S4, affected by deterioration (marker = 200 µm). At the centre: SEM image of sample S5, affected by deterioration (marker = 1 mm). On the right: SEM image of sample S4 (marker = 500 µm).

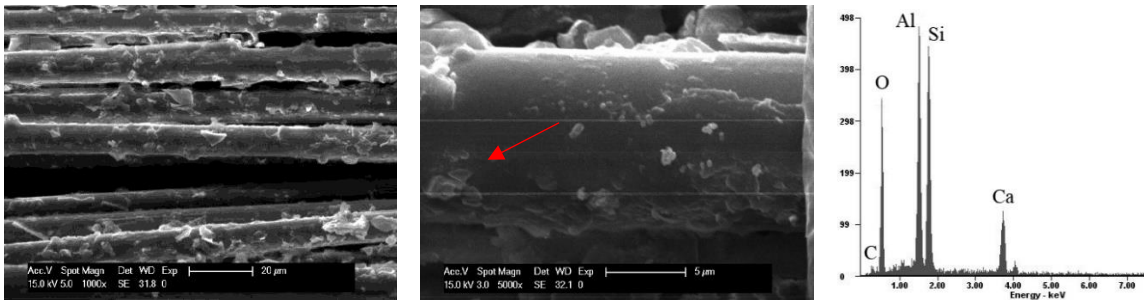

Fig. 19 Glass fibre samples. On the left: SEM image of the fibres in sample S6 (marker = 20 µm). At the centre: a fibre of sample S6 observed at greater magnification (marker = 5 µm). On the right: EDS analysis of the same fiber shown at the centre, carried out in the point indicated by the red arrow.



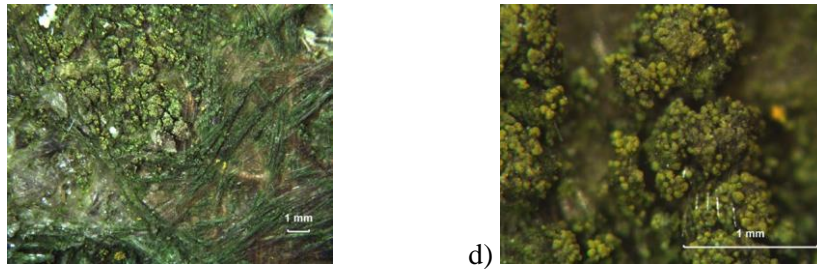

Fig. 20 SOM images of: a-b) cross sections of fiberglass sample S7, affected by delamination (marker = 1 mm); c) external surface of the fiberglass sample S4, with lichens growing on the mat (marker = 1 mm); and d) a detail of the lichens in c) (marker = 1 mm).

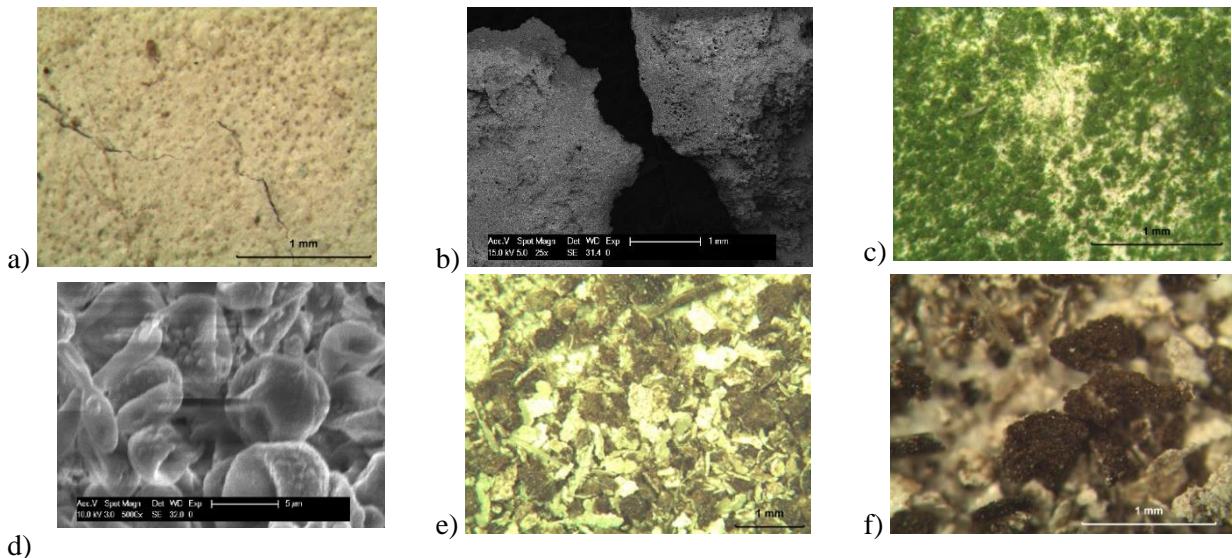

Fig. 21 a) SOM image of the white paint (sample S8), with pits and crevices (marker = 1 mm); b) SEM image with the white paint (sample S8) on the right and the black paint (sample S9) on the left (marker = 1 mm); c) SOM image of the white paint covered by the green patina (sample S10) (marker = 1 mm); d) SEM image of the green patina, composed of microorganisms (sample S11) (marker = 5 µm); e-f) SOM images of the powder that constitutes dark soiling (samples S12 and S13, respectively) (marker = 1 mm), where a substantial difference between white pieces (belonging to the paint) and dark pieces (belonging to the deposit) can be observed.

5. Which conservation intervention?

The architectural and artistic value of the dome and the graffito by Blu have been widely acknowledged by the community and this made the local Municipality protect the Woodpecker disco club in its regulations. However, the results obtained in this study clearly indicate that the enterprising and experimental nature of the dome involves severe intrinsic problems in terms of materials' durability. In particular:

- the local environment is extremely aggressive towards the fiberglass elements, which are exposed to high temperatures and direct solar radiation during the summer months, high relative humidity (and hence condensation) along all the year, direct and wind-driven rains and occurrence of freeze thaw cycles during the winter months. This produced a severe ageing of the resin matrix, delamination of the composite and local disruption of the fiberglass. Moreover, the external surface of the dome, probably made rougher and rougher by deterioration, became an ideal substrate for lichens growth, which exacerbated the

deterioration by keeping the fiberglass moist and by inducing detrimental chemical and physical-mechanical effects due to metabolic processes and hyphae penetration;

- the use of carbon steel was not compatible with the periodic immersion of the base of the dome in brackish water (approximately from autumn to spring) and the high amount of chloride caused the perforation of the steel elements, which are now almost completely corroded at the basis. The original wrapping of the steel elements with fiberglass was obviously not enough for protecting steel from corrosion and it is even counterproductive, as it presently hinders the inspection of the corrosion state of the steel tubular elements.

The graffiti arises challenging problems too, as it is constituted by water-based tempera paint, which is not fully compatible in terms of adhesion with the fiberglass substrate. Moreover, the condensation affecting the dome and its location in the middle of the fields caused the powdering of this water-sensitive paint and the growth of detrimental algae on the graffiti (especially in the part exposed to north), threatening its conservation.

According to these observations, it is clear that the dome and the graffiti were manufactured taking into no account the problem of durability, and it is even probable that their temporariness was consciously desired by their relevant authors, as suggested in the Introduction.

The application of the principles reported in the Restoration Charters which are currently followed in the conservation of traditional historic architecture, and in particular the requirements of minimum intervention, authenticity and compatibility (“Athens Charter”, 1931 [84], and “Venice Charter”, 1964 [85]), result particularly challenging here, because they require the repair and conservation of the present materials where possible and the reconstruction of the lost ones where necessary. This requires new and original solutions, materials and technologies, involving also a very high budget. Moreover, it will be necessary to protect these extremely vulnerable materials from an apparently unavoidable deterioration, which is even more challenging.

Considering all the aspects discussed above, a tailored conservation procedure was proposed, trying to apply the principles mentioned above. This approach highlighted a series of peculiarities, which perfectly fit the ongoing animated debate about the fact that the restoration of modern architecture should be treated as a separate discipline from the conservation of traditional architecture [2-3, 86].

Following the conservation principles arises some remarkable concerns:

- given the precarious structural conditions of the dome, it will be necessary to work with utmost caution, hence performing the conservation intervention directly onsite in the dome appears hardly feasible from a practical point of view, unless very expensive procedures are purposely set-up;
- a large part of the steel structure requires to be substituted and most probably it will be also

necessary to adapt the structure to current laws for structural elements (probably requiring changes in the size of the steel elements or joints).

Due to these challenges, dismantling the dome looks the most viable solution for conservation. In this way, it will be possible to work on each component with easier, more controllable and safer technologies and also to substitute completely the metal frame. The procedure proposed, which has no precedents in the conservation field, involves the following steps:

- pre-consolidation, cleaning and consolidation of the graffito, in order to preserve it during the subsequent phases. Given the nature of the materials (water-based paints applied over a smooth fiberglass substrate) and their deterioration (presence of algae, powdering and detachment of the paint from fiberglass), well-established cleaning and consolidation procedures for this specific case do not exist. Hence, it will be necessary to select the most suitable materials after some preliminary testing. The consolidant will be selected in order to improve the adhesion of the paint to the underlying fibreglass;
- construction of a temporary supporting structure inside the dome;
- dismantling of the vaults. Operationally, a cut will be made in the position indicated by the dotted red line in Fig. 9, left. In this way, the internal surface of the vaults will be totally conserved and will likely be not affected by the dismantling operations. Conversely, the metallic tubes will be entirely removed and replaced (see below);
- transportation of the vaults to a place close to the structure or to a laboratory, where they will be restored. Purposely manufactured moulds, adapting to the vault's internal surface, will be necessary for transportation;
- repair of the external fiberglass surface, according to the following steps: cleaning, by removal of lichens and deteriorated fibreglass parts; application of a new layer of unsaturated polyester resin (and additional layers of fibre mat, if necessary) up to obtaining a smooth surface and a uniform thickness;
- repair of the internal fiberglass surface where graffito is not present, according to the following steps: removal of powdering and/or detached parts, cleaning and repair of the defects in the fiberglass with unsaturated polyester resin;
- application of new stainless steel arches suitable for marine environment (e.g., AISI 316), in substitution of the existing steel frame. The entire substitution of the metal structure is expected to be cheaper and to prevent any galvanic corrosion deriving from the joining of two different kinds of steel. This substitution will also allow to calculate the new steel frame according to current regulations and to possibly increase the section and/or thickness of the steel tubes, if necessary. In fact, after the application of the stainless steel elements, they will

be overlaminated with new fiberglass according to the original technique, thus making not necessary that the size of the new steel frame is identical to the previous one. As the original fiberglass will be cut, the overlamination will be carried out paying attention to provide an appropriate overlapping between the new and the original fiberglass. The technology of the new metal frame will be kept identical to that of the existing one, in terms of design concept and joining solutions;

- onsite assembling of the repaired vaults, which will be connected to a reconstructed metallic structure at the basis (as in Fig. 7) and to a new top ring. All the metallic elements and the bolts will be made of the same kind of stainless steel used for the arches. The bolting system between the vaults will be the same originally used (Fig. 9). All the protective elements in Fig. 6, including mortar and sealing, will be reconstructed using materials exhibiting a suitable resistance to the specific environment of the dome;
- application of a protective coating on all the external surface of the dome, having a good adhesion with fibreglass and providing a satisfactory protection against aggressive environment. A functional hybrid coating providing reflective and antimicrobial performance should be considered, after preliminary testing, or a gel coat used for contemporary fiberglass domes [44]. The application of a protective coating over the internal surface will be considered as well, although not necessarily of the same kind;
- application of new aluminium elements over the vaults' joints, to prevent rain infiltration.

The repair intervention described above involves the almost complete conservation of the fiberglass ribs (with the graffito) and the complete substitution of the steel frames, with a final overlamination of the new frames with fiberglass. It is noteworthy that this procedure allows to increase the size of the steel elements, if necessary. In fact, besides being affected by corrosion, the present frame was built 53 years ago, hence it is not necessarily compliant with current regulations for steel structures and the need to increase the cross-sections seems probable, especially considering that Cervia is presently classified by Italian laws [87] as seismic Zone 2 (“There may be severe earthquakes in this area”; minimum acceleration with a probability of exceeding 10% in 50 years: > 0.15 g; maximum acceleration with probability of exceeding 10% in 50 years: less or equal to 0.25 g). Apart from the increase of the steel tubes thickness and cross section, the scheme and the junctions of the new steel structure will remain the same of the existing one. The presence of bolts rather than weld joints is regarded as advantageous also in the light of the use of stainless steel. Details of the design of the new steel frame structure are not provided in the present paper, as its calculation can be done through current methodologies and is beyond the scope of the paper. Similarly, the structural behaviour of the circular concrete slab at the basis of the dome, which however does not exhibit any deterioration

pattern, was not considered here.

Besides the interventions described above, it will be necessary to take additional measures to prevent steel corrosion. These might include the removal of water submerging the basis of the dome during the winter months (e.g., by dewatering pumps), or at least the periodical inspection of the corrosion state of the steel arches (e.g., by electrical potential measurement). The nature of the periodical inspections should be planned in advance, setting up all the measures necessary to facilitate them during the repair of the dome.

Notably, the repair of the external surface of the fiberglass dome in order to make the surface smooth and the application of a final protective coating are expected to provide an increased durability to the dome, thus overcoming some of the intrinsic ageing problem of materials in ‘temporary architecture’. It is evident that this kind of repair and conservation procedure, which complies with the methodological approach and the requirements of “conservative restoration” would be most likely unsustainable from the economical point of view. Alternative solutions for the dismantling and the reassembling of the dome could be taken into account, including a different type of joint between vaults that makes all the operations easier.

The total reconstruction of the dome with new materials identical (or at least similar) to the original ones, although probably cheaper, would arise some key problems:

- it would be in contrast with the shared principles of “authenticity” and “minimum intervention” of conservative restoration recommended by the Restoration charters;
- it would involve the loss of the graffito;
- it would not provide any guarantee about the future durability of the dome, given the very aggressive environment in which the structure is located and the intrinsically low durability of fibreglass.

Anyway, it is evident that substantial interventions must be done in order to meet the performance and safety standards required by current regulations. This is a frequent problem in the restoration of XX century architectural heritage, particularly involving, for instance, the study of suitable solutions for the conservation of the thin metal window frames, characterizing modern buildings, and the compliance with energy saving requirements [88-89].

6. Conclusions

In the present paper, the dome of the Woodpecker dance club in Milano Marittima, built in 1968, was investigated. The dome is made of fibreglass vaults and a carbon steel structure and it was internally painted with a valuable graffito by Blu some decades after its construction. Due to the 40-year state

of abandonment, the immersion in brackish groundwater during every winter season and the extremely aggressive environment, the dome materials are harshly deteriorated, and even irrecoverably lost in some parts. The steel tubes are irreparably damaged up to 2 meters height, connecting elements are heavily affected by corrosion, fibreglass vaults suffer a widespread deterioration and extensive growth of lichens. The graffiti is affected by biological deterioration and powdering.

The tests and analyses performed in this study not only allowed to disclose the nature of the materials and technologies used in the dome and their deterioration causes/mechanisms, but also clearly showed that the materials used in the dome and the graffiti are intrinsically vulnerable to the local environment, hence not durable enough for that specific location.

Although the local and scientific communities acknowledged the dome and the graffiti for their high artistic value and the Municipality established a “conservative restoration” constraint over any intervention, the feasibility of a conservative restoration intervention was discussed in this study, starting from the information collected on the materials and their deterioration.

A conservation procedure was proposed in the paper, which allows, on the one hand, to conserve the general design concept and most of the fiberglass dome and, on the other hand, to fix the existing deterioration problems and increase the general durability of the structure. It is the first time that the conservation of a multi-material heritage building made of fiberglass, steel and graffiti paintings is discussed in the literature, so the present study can be considered innovative from the point of view of materials, technical issues and methodological approach.

The results clearly showed that severe problems and contradictions arise when conservation principles are applied to the restoration of this XX century heritage, with particular reference to the following issues:

- the authors of the dome and the graffiti did not intend to create durable artefacts, and in fact the materials used are prone to deterioration and somehow ‘temporary’. This fights with the essence of conservation itself;
- the conservative restoration of the dome and the graffiti requires new tailored materials and solutions, which make the repair of the structure extremely challenging and expensive (more than the complete reconstruction of the dome). In fact, the intervention is expected not only to repair the existing structure, but also to solve the problem of temporariness, providing the structure with a satisfactory durability also in a highly aggressive environment.

The Woodpecker dance club is a complex work of art, including landscape design, hydraulic systems, pavements and the dome. Although all of them are worth of investigation, the present paper focuses on the dome, which represents the most challenging and innovative aspect in the dance club

conservation from the point of view of materials deterioration and conservation (fiberglass, steel and graffiti paints). The calculation and verification of the steel frame structure, which can be done according to current regulations, was not carried out, as it was beyond the scope of the present paper. Other aspects, such as the interventions on the surrounding natural environment (plants and trees, water system, landscape) and the preservation of the original entertainment function (involving the fulfilment of the present fire safety requirements) were not discussed in this paper. It is noteworthy how the conservation of this contemporary structures requires a multi-disciplinary effort, as it seems one of the challenging tasks involving the preservation of XX Century heritage.

Acknowledgements

The Municipality of Cervia (in particular, Dr. Daniela Poggiali and Dr. Rossella Fabbri) is gratefully acknowledged for the interest showed in this research and for the actual helpfulness in the collection of information and documents about the Woodpecker.

Thanks to Dr. Enrico Sassoni (University of Bologna, Italy), for his help in SEM observations and EDS analyses, and to Dr. Micaela Degli Esposti (University of Bologna, Italy), for her support in the interpretation of FT-IR analysis.

Thanks to Prof. Antonio Motori (University of Bologna, Italy), for the useful suggestions on fiberglass, to Matteo Rusticali for the fruitful discussion about shipyard techniques, to Adele Galetti (Leonardo S.r.l., Italy), Chiara Fabbri and Marco Cosmi for their suggestions about paints, and to Gabriele Antolini (ARPAE) for providing raw environmental data. Thanks to Andrea Bonavita for his support in the photos acquisition by drone.

Dr. Matteo Domeniconi, Riccardo Guerrini (Balsera Costruzioni), Spazi Indecisi and MAGMA (local associations) are gratefully acknowledged for their support in the research on the history and documents about the Woodpecker.

Marco Monti, Gian Luca Zangheri and Antonello Zoffoli are gratefully acknowledged for allowing the use of their photos.

REFERENCES

- [1] Gimma M. G. (editor), *Il restauro dell'architettura moderna*. BetaGamma, Viterbo, Italy, 1993
- [2] Carbonara G. (editor), *Il restauro del Moderno*. Parametro 266 (2006)

- [3] Poretti S., Specificità del restauro del moderno. *Territorio* 62 (2012) 88-94
- [4] Marcosano Dell'Erba C., *Rifare il nuovo. Temi e tecniche dell'intervento contemporaneo sugli edifici di architettura moderna.* Gangemi, Roma, 1996
- [5] Salvo S., Conservation and modern architecture. Fortune and misfortune of the School of Mathematics at Rome University (G. Ponti, 1932-1935). *Frontiers of Architectural Research* 4 (3) (2015) 186-201
- [6] Moniz G.C., Canziani A., Quiroga C., Learning to reuse modernity: the educational challenge. *Proceedings of the 15th International Docomomo Conference - Metamorphosis: The Continuity of Change*, 2018, 532-539
- [7] Gultekin N. T., Evaluation of the conservation of modern architectural heritage through Ankara's public buildings. *IOP conference series. Materials science and engineering* 245 (8) (2017) 082046
- [8] Allan J., Points of balance: Patterns of practice in the conservation of modern architecture. *Journal of architectural conservation* 13 (2) (2007) 13-46
- [9] Nomura M., Changes in the preservation of modern architectural materials in recent years in Japan. *Technology Reports of Kansai University* 61 (2019) 45-51
- [10] Pisano M., Sanjust P., An example of good heritage practice in modern buildings conservation. *Rehabend, 6th Euro-American Congress on Construction Pathology, Rehabilitation Technology and Heritage Management*, 2016, 2223-2229
- [11] Ayon A., Historic fabric vs. design intent: authenticity and preservation of modern architecture at Frank Lloyd Wright's Guggenheim Museum. *Journal of architectural conservation* 15 (3) (2009) 41-58
- [12] Crippa M.A., Restoration of the modern: critical fortune, uncertainties over implementation. *Territorio* 62 (2012) 68-75
- [13] Walker A., Lee Y., Conserving modern buildings: consent or constraint. *Property management* 11 (3) (1993) 226-233
- [14] Macdonald S., Reconciling authenticity and repair in the conservation of modern architecture. *Journal of architectural conservation* 2 (1) (1996) 36-54
- [15] ISC20C ICOMOS, Madrid - New Delhi Document. *Approaches to the conservation of Twentieth-Century cultural heritage*, 2017
- [16] ATRIUM, *Guidelines for the Restoration of Modern Architecture*, 2015
- [17] Italian law D. L. n. 42/2004 "Codice dei beni culturali e del paesaggio", and subsequent modifications and additions
- [18] Dari E., Orioli V., *Milano Marittima 100. Le architetture e la città.* Edit Faenza, Faenza, 2012

- [19] Bertoni F., Rava D., Filippo Monti architetto. Valfrido, Faenza, 2009
- [20] Bertoni F., Filippo Monti in conversazione con Franco Bertoni. Edit Faenza, Faenza, 2003
- [21] Mantovani L., Ricci M., Woodpecker. Seigradi, Periodici percorsi culturali, n. 3, 2012, online journal
- [22] Parlando con Filippo Monti, interview with Filippo Monti published on the website of Seigradi - Periodici percorsi culturali, online journal, on 18th November 2015 (<http://www.seigradirivista.it/blog.php?id=85>)
- [23] Ferilli G., Il porto di Ravenna. Dalla ricostruzione ai giorni nostri. Longo, Ravenna, 1999
- [24] Monti F., Aspetti dell'architettura d'oggi nella riviera romagnola. Studi Romagnoli, n.18, A.XVIII, Edizione Fratelli Lega, Cesena, 1967
- [25] Lelli G., La linea della luce. Polis - Idee e cultura nelle città, n.14, A.IV, Koinè, Milano, 1998
- [26] Knippers J., Cremers J., Gabler M., Lienhard J., Atlante delle materie plastiche: materiali, tecnologie, progettazione. Pitagora Editrice, Bologna, 2002
- [27] Minguzzi G., Fiber Reinforced Plastics. Alinea, Firenze, 1998
- [28] Dreaming for reality. Conversazione con Filippo Monti, 124 gradi, n.3, Clueb, Bologna, 2006
- [29] Blu interview, interview with Blu done in 2005 and published online on wildstylers.com (<http://www.wildstylers.com/intervista-a-blu/>) (accessed in October 2017)
- [30] Riva A. (editor), Street art, sweet art: dalla cultura hip hop alla generazione pop up. Skira, Milano, 2007
- [31] Lewisohn C., Street art: the graffiti revolution. Tate publishing, London, 2008
- [32] Blu, Minima muralia: 15 years painting, Zooo, 2018
- [33] Galal C., Street art. Auditorium, Milano, 2009
- [34] Municipality of Cervia, RUE (“Regolamento Urbanistico Edilizio” – Urban and Building Regulations), adopted in 2017
- [35] Maggi V., Nonni E., Faenza 100 anni di edilizia. Un Novecento da ricordare 1951-2010. Tipografia Faentina, Faenza, 2011
- [36] Normandin K., The Eames House. Conserving a California Icon. The GCI Newsletter 28 (1) (2013) 10-12
- [37] Calderoni L., Verdeschi P., Il restauro del Moderno. Villa La Saracena a Santa Marinella di Luigi Moretti. recuperoeconservazione_magazine 163 (2021) 56-65
- [38] Cabral-Fonseca S., Correia J.R., Custódio J., Silva H.M., Machado A.M., Sousa J., Durability of FRP - concrete bonded joints in structural rehabilitation: A review. International Journal of Adhesion and Adhesives 83 (2018) 153-167

- [39] Frigione M., Lettieri M., Durability issues and challenges for material advancements in FRP employed in the construction industry. *Polymers* 10 (3) (2018) 247
- [40] Zaman A., Gutub S.A., Wafa M.A., A review on FRP composites applications and durability concerns in the construction sector. *Journal of Reinforced Plastics and Composites* 32 (24) (2013) 1966-1988
- [41] Beerkens L., Breder F., Temporary Art? The Production and Conservation of Outdoor Sculptures in Fiberglass-Reinforced Polyester. *The GCI Newsletter* 27 (2) (2012) 13-15
- [42] Beerkens L., Supply S., Bechthold T., Matti Suuronen's "Futuro"-Prototype, 1968. Back in business in the 21st century. *Proceedings of the Conference Future Talks 2011: Technology and Conservation of Modern Materials in Design*, 2011, 129-136
- [43] Stigter S., Beerkens L., Schellen H. L., Kuperholc S., Joep van Lieshout's Mobile Home for Kröller-Müller: outdoor polyester sculpture in transit. *Proceedings of the 15th ICOM-CC Conference* 1 (2008) 489-495
- [44] Olenkov V.D, Pogorelov S.N., Kolmogorova A.O., Innovations and traditions: application of fiberglass for revival of dome roofs of church monuments of architecture. *IOP Conf. Series: Materials Science and Engineering* 451 (1) (2018) 012064
- [45] Giannetti I., Civil engineering heritage: country profile – Italy. *Proceedings of the Institution of Civil Engineers - Engineering History and Heritage* 171 (1) (2018) 25-33
- [46] Brueckner R., Lambert P., Renovation of the deck of a major listed bridge structure. *WIT Transactions on the Built Environment* 118 (2011) 307-317
- [47] Cano E., Bastidas D. M., Argyropoulos V., Fajardo S., Siatou A., Bastidas J.M., Degriigny C., Electrochemical characterization of organic coatings for protection of historic steel artefacts. *Journal of Solid State Electrochemistry* 14 (3) (2010) 453-463
- [48] Dutton A., Clarence bridge, Regent's park, London, UK: The assessment and repair of a wrought iron lattice bridge. *Proceedings of the ICE - Engineering History and Heritage* 170 (4) (2017) 189-196
- [49] Garavaglia E., Basso N., Sgambi L., Historic roof structures: Life-cycle assessment and selective maintenance strategies. *Proceedings of the 6th International Symposium on Life-Cycle Civil Engineering, IALCCE 2018*, 2019, 345-351
- [50] Sandrolini F., Franzoni E., Cuppini G., Caggiati L., Materials decay and environmental attack in the *Pio Palace* at Carpi: a holistic approach for historical architectural surfaces conservation. *Building and environment* 42 (5) (2007) 1966-1974
- [51] Alves A. N., Why can't our wall paintings last forever? The creation of identity symbols of street art. *Street Art and Urban Creativity* 3 (1) (2017) 12-19

- [52] MacDowall L., A boneyard of data: graffiti and street art's temporalities. *Street Art and Urban Creativity* 2 (2) (2016) 48-59
- [53] Gayo E. G., Street art conservation: The drift of abandonment. *Street Art and Urban Creativity* 1 (1) (2015) 99-100
- [54] Mania P., Petrilli R., Cristallini E. (eds.), *Arte sui muri della città. Street Art e Urban Art: questioni aperte*. Round Robin, Roma, 2017
- [55] Caligiana G., Cesari F., *I materiali compositi*. Pitagora Editrice, Bologna, 2002
- [56] Crivelli Visconti I., Caprino G., Langella A., *Materiali compositi: tecnologie, progettazione, applicazioni*. Hoepli, Milano, 2009
- [57] Shashoua Y., *Conservation of plastics: materials science, degradation and preservation*. Butterworth-Heinemann (Elsevier), Oxford, 2008
- [58] https://www.gruppohera.it/gruppo/attivita_servizi/business_acqua/qualita/qualita_acqua_hera/qualita_media_comuni/-ravenna/pagina256.html, report published on Hera website, accessed in October 2019
- [59] Chiacchierini E., Lucchetti M.C., *La vetroresina: proprietà chimico-fisiche, aspetti tecnici ed economici*. Kappa, Roma, 1984
- [60] Knuutinen U., Kyllonen P., Two case studies of unsaturated polyester composite art objects. *E-Preservation Science* 3 (2006) 11-19
- [61] Verleye G.A.L., Roeges N.P.G., De Moor M.O., *Easy Identification of plastics and rubbers*. Rapra Technology Ltd, Shawbury, Shrewsbury, UK, 2001
- [62] Silverstein R.M., Webster F.X., Kiemle D.J., *Spectrometric Identification of organic compounds*. John Wiley & Sons, Hoboken, 2005
- [63] Derrick M.R., Stulik D.C., Landry J.M., *Infrared spectroscopy in conservation science*. The Getty Conservation Institute, Los Angeles, 1999
- [64] Paauw M., Pizzi A., A FT-IR analysis method for simple unsaturated polyesters. *Journal of Applied Polymer Science* 42 (5) (1991) 1377-1384
- [65] Reddy K.O., Shukla M., Maheswari C.U., Rajulu A.V., Evaluation of mechanical behavior of chemically modified Borassus fruit short fiber unsaturated polyester composites. *Journal of Composite Materials* 46 (23) (2012) 2987-2998
- [66] Belloul N., Hamadache H., Benyahia A.A., Serier A., Effect of the aggressive environment on the damage of a glass polyester composite developed by hand layup process. *Advances in Materials Science and Engineering*, 2015, 207491
- [67] De La Caba K., Guerrero P., Eceiza A., Mondragon I., Kinetic and rheological studies of two unsaturated polyester resins cured at different temperatures. *European Polymer Journal* 33 (1)

(1997) 19-23

- [68] Wang Y., Meng J., Zhao Q., Qi S., Accelerated ageing tests for evaluations of a durability performance of glass-fiber reinforcement polyester composites. *Journal of Materials Science and Technology* 26 (6) (2010) 572-576
- [69] Salvadori B., Cantisani E., Colombini M.P., Tognon C.G.R., Painted fiberglass-reinforced contemporary sculpture: investigating composite materials, techniques and conservation using a multi-analytical approach. *Applied Spectroscopy* 70 (1) (2016) 174-185
- [70] Zhao Q., Jia Z., Li X., Ye Z., Surface degradation of unsaturated polyester resin in Xe artificial weathering environment. *Materials and Design* 31 (9) (2010) 4457-4460
- [71] Laoubi K., Hamadi Z., Ahmed Benyahia A., Serier A., Azari Z., Thermal behavior of E-glass fiber-reinforced unsaturated polyester composites. *Composites Part B: Engineering* 56 (2014) 520-526
- [72] Gu J.-D., Ford T., Thorp K., Mitchell R., Microbial growth on fiber reinforced composite materials. *International Biodeterioration and Biodegradation* 37 (3-4) (1996) 197-204
- [73] Thorp K. E. G., Crasto A.S., Gu J.-D., Mitchell R., Biodegradation of composite materials. *Proceedings of the Tri-Service Conference on Corrosion, 1994*, 303-314
- [74] Wagner P.A., Little B.J., Hart K.R., Ray R.I., Biodegradation of composite materials. *International Biodeterioration and Biodegradation* 38 (2) (1996) 125-132
- [75] Cappitelli F., Principi P., Sorlini C., Biodeterioration of modern materials in contemporary collections: can biotechnology help? *Trends in Biotechnology* 24 (8) (2006) 350-354
- [76] Gu J.-D., Microbiological deterioration and degradation of synthetic polymeric materials: recent research advances. *International Biodeterioration and Biodegradation* 52 (2) (2003) 69-91
- [77] Lugauskas A., Levinskaite L., Pečiulyte D., Micromycetes as deterioration agents of polymeric materials. *International Biodeterioration and Biodegradation* 52 (4) (2003) 233-242
- [78] Cappitelli F., Sorlini C., Microorganisms attack synthetic polymers in items representing our cultural heritage. *Applied and Environmental Microbiology* 74 (3) (2008) 564-569
- [79] Hennemann G., Eugênio H., Bolina F., Rodrigues E., Tutikian B., Verification of the reaction to fire of water-based and oil-based enamel paints used as finish of walls in residential buildings. *Revista Materia* 24 (4) (2019) e12515
- [80] Flick E. W., *Water-Based Paint Formulations*, Vol. 3. Noyes Publications, Park Ridge, 1994
- [81] Fragoso D., Costa S., Martins E., Dias F.R., Rosas P., Candeias A., Carvalho M. L., Manso M., Through The Hermit-Rediscovering António Dacosta's lost painting. *Microchemical Journal* 126 (2016) 474-479

- [82] Sutna K.K., Jacob S., Joseph R., Paint formulation using water based binder and property studies. *Macromolecular Symposia* 277 (1) (2009) 144-151
- [83] Epley B. A., Rogge C. E., Prior states: evolution of composition and color in two Barnett Newman paintings. *Applied Physics A: Materials Science and Processing* 121 (3) (2015) 987-998
- [84] 1st International Congress of Architects and Technicians of Historic Monuments, “Athens Charter”, 1931
- [85] 2nd International Congress of Architects and Technicians of Historic Monuments, “Venice Charter”, 1964
- [86] MacDonald S., Levin J., Modernity, Temporality and Materiality. A Discussion about the Conservation of Modern Architecture. *The GCI Newsletter* 28 (1) (2013) 18-23
- [87] Italian law O. P. C. M. n. 3274/2003 “Primi elementi in materia di criteri generali per la classificazione sismica del territorio nazionale e di normative tecniche per le costruzioni in zona sismica”, and subsequent modifications and additions
- [88] Franco G., Musso S., Conservation of modern architecture and the adaptation of new requirements. *Proceedings of the 14th International Docomomo Conference – Adaptive Reuse: The Modern Movement Towards the Future*, 2016, 638-644
- [89] Stazi F., Mugianesi E., Munafò P., Recommendation for restoration of Modern buildings with stone cladding and steel windows: A multi-disciplinary approach on a significant case study. *Construction and Building Materials* 37 (2012) 728-737