



ALMA MATER STUDIORUM
UNIVERSITÀ DI BOLOGNA

ARCHIVIO ISTITUZIONALE
DELLA RICERCA

Alma Mater Studiorum Università di Bologna Archivio istituzionale della ricerca

The future of ultra-wideband localization in RFID

This is the final peer-reviewed author's accepted manuscript (postprint) of the following publication:

Published Version:

The future of ultra-wideband localization in RFID / Dardari, Davide*; Decarli, Nicolo; Guerra, Anna; Guidi, Francesco. - ELETTRONICO. - 2016:(2016), pp. 7487998.1-7487998.7. (Intervento presentato al convegno 2016 IEEE International Conference on RFID, RFID 2016 tenutosi a Orlando, FL, USA nel 3-5 May 2016) [10.1109/RFID.2016.7487998].

Availability:

This version is available at: <https://hdl.handle.net/11585/621241> since: 2019-03-21

Published:

DOI: <http://doi.org/10.1109/RFID.2016.7487998>

Terms of use:

Some rights reserved. The terms and conditions for the reuse of this version of the manuscript are specified in the publishing policy. For all terms of use and more information see the publisher's website.

This item was downloaded from IRIS Università di Bologna (<https://cris.unibo.it/>).
When citing, please refer to the published version.

(Article begins on next page)

This is the post peer-review accepted manuscript of:

D. Dardari, N. Decarli, A. Guerra and F. Guidi, "The future of ultra-wideband localization in RFID," 2016 IEEE International Conference on RFID (RFID), Orlando, FL, 2016, pp. 1-7.

<https://doi.org/10.1109/RFID.2016.7487998>

The published version is available online at:

<http://ieeexplore.ieee.org/stamp/stamp.jsp?tp=&arnumber=7487998&isnumber=7487991>

© 2016 IEEE. Personal use of this material is permitted. Permission from IEEE must be obtained for all other uses, in any current or future media, including reprinting/republishing this material for advertising or promotional purposes, creating new collective works, for resale or redistribution to servers or lists, or reuse of any copyrighted component of this work in other works

The Future of Ultra-Wideband Localization in RFID

(Invited Paper)

Davide Dardari*, Nicol  Decarli*, Anna Guerra*, and Francesco Guidi†

* DEI, University of Bologna, Italy (email: {davide.dardari, nicolo.decarli, anna.guerra3}@unibo.it)

† CEA, LETI, MINATEC Campus, Grenoble, France (e-mail: francesco.guidi@cea.fr)

Abstract—In the new scenarios foreseen by the Internet of Things (IoT), industrial and consumer systems will be required to detect and localize tagged items with high accuracy using cheap, energy autonomous, and disposable tags. To meet these challenging requirements, the adoption of passive ultra-wideband (UWB) radio-frequency identification (RFID) appears a promising solution to overcome the limitations of current Gen.2 RFID standard. In this paper we provide a survey on recent developments in the field of UWB-RFID by discussing the main advantages and open issues in providing high positioning accuracy with energy autonomous devices. Successively, we envision the possible cutting-edge technologies for next generation UWB-RFID as a key enabler for the IoT.

Index Terms—RFID, Localization, UWB, UHF

I. THE NEED FOR LOCATION-AWARE SERVICES

In recent years, especially after the introduction of the second generation (Gen.2) UHF standard, the radio-frequency identification (RFID) technology is rapidly replacing bar codes in items tagging thanks to the capability to work even in the absence of direct visibility and to store/retrieve information on/from tags. The cheapest RFID tags with the largest commercial potential are *passive*, in which the energy necessary for tag-reader communication is harvested from the reader's interrogation signal or the surrounding environment and the information is transmitted through backscattered signals [1]. Passive RFID technology has become more and more pervasive due to the availability of extremely low-cost tags (a few cents), thus making the range of actual and potentially new applications practically unlimited. As a consequence, the requirements for future RFID systems are becoming more and more demanding. Specifically, next generation RFID is expected to provide not only reliable identification but also sensing and high-definition tag localization functionalities [2], [3]. On the one hand energetically autonomous and not invasive sensors (tags) could be used for biomedical (e.g., smart plasters), to monitor drugs for efficient hospital management or in the food chain to prevent the risk of food counterfeit and adulteration. On the other hand, the capability to localize in real-time with high-accuracy (few centimeters) tags pervading the environment would enable unexplored context-aware applications and huge market perspectives such as in the field of item searching in logistic or shopping mall scenarios. It is possible to envision that in a near future every object will be tagged to take part of augmented reality-based applications [4], which allow virtual imagery to exactly overlay physical objects in real-time as illustrated in Fig. 1.

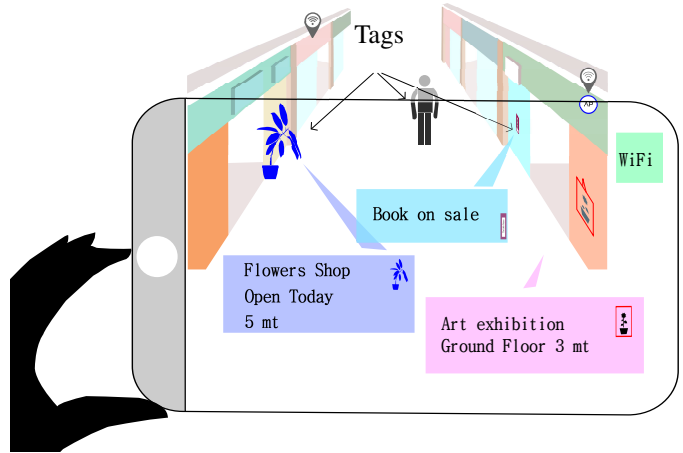

Fig. 1. Envisioned future scenario: a user, with its own personal device, can localize and interact with tagged objects placed in the surrounding environment.

These perspectives highlight the main limitations of actual HF- and UHF-RFID technologies which were initially conceived just to replace bar codes and hence only for identification at higher distances. Limitations regarded the absence of sensors on tags and localization capability, the limited operating range (below 10 m with UHF tags, below 1 – 2 m using HF tags), the need of dedicated and energy-hungry hardware to read the tag, and lack of integration with mobile communication standards. Nowadays, such limitations have been in part overcome through the introduction of significant improvements in current standards such as embedded sensors on tags to monitor physical parameters, the integration of HF readers in last generation smartphones (NFC standard¹), and the availability of some solutions offering rough localization capabilities. Unfortunately these improvements did not come for free. In fact, they have been achieved at the expense of a further reduced operating range (e.g., NFC smartphones can read tags up to 10 – 20 cm) or more complex readers (e.g., using large antenna arrays to localize tags based on angle-of-arrival (AOA) measurements) (see Sec. II).

It is clear that the above-mentioned requirements cannot be completely fulfilled by the current first and second generation RFID. Nowadays, high-performance wireless sensing and localization are offered by distinct technologies such as wireless sensor networks (WSNs) (e.g., ZigBee standard [5]),

¹<http://www.nearfieldcommunication.org/tecnology.html>

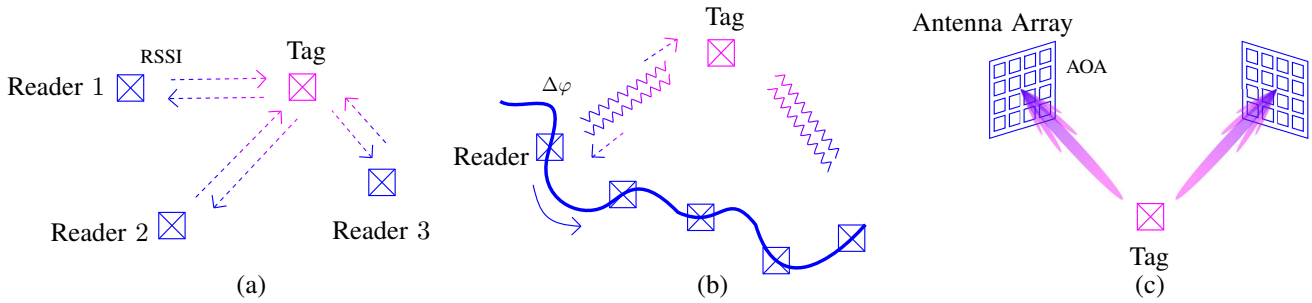

Fig. 2. Main localization techniques using UHF-RFID.

and real-time locating systems (RTLS) using battery-powered tags [6]. There is the need to merge the advantages of currently separated RTLS and WSN worlds through a technological shift.

For what high-accuracy localization using energy autonomous tags is concerned, some important progresses have been made towards this direction. An example is given by the merging of the ultra-wideband (UWB) technology, so far used in active RTLS systems, with the backscatter modulation principle, which is the basis of UHF-RFID.

For this reason we first briefly revise current ultra-high frequency (UHF) localization techniques in Sec. II, and successively, in Sec. III, we pose the attention to UWB-based solutions. In particular, we first explain the UWB backscattering principle, successively we illustrate the recent results achieved in related research projects by discussing the main advantages and open issues when providing high positioning accuracy with energy autonomous devices with respect to positioning systems using Gen2. RFID. In the last section, a look is given at possible cutting-edge solutions which are expected in the future to make next-generation RFID a key enabler for the “Internet of Things” (IoT) paradigm.

II. LOCALIZATION USING GEN.2 RFID

Before introducing emerging technologies using UWB signals, we briefly describe some recently proposed solutions that offer positioning capabilities using standard Gen.2 RFID. In fact, even though Gen.2 RFID was not conceived for positioning, rough localization information can be obtained by exploiting one or a mix of the following signal features: received signal strength indicator (RSSI) (Fig. 2-a), carrier phase (Fig. 2-b), and AOA (Fig. 2-c). Other approaches can be found in [7], [8].

RSSI-based solutions rely on the fact that, in ideal conditions, the larger the distance of the tag the smaller is the received power, and multiple RSSI measurements can be combined to derive distance and hence position information. Despite its simplicity, this method is very sensitive to random signal fluctuations caused by multipath that could make the correlation between RSSI and distance weak, and hence the position estimation poorly accurate and extremely unreliable, even if some improvements of the localization accuracy have been obtained [9].

Fig. 2-(b) shows the case in which the reader collects several carrier phase measurements from different locations (e.g., using an handheld terminal or moving reader) as response of an intended fixed tag. Accurate tag positioning in the order of a few centimeters can be obtained in principle by properly combining them as in virtual antenna arrays. Unfortunately, due to the 2π periodicity of phase measurements, corresponding to the signal wavelength (about 30 cm at UHF), phase-based localization suffers from phase-ambiguity that makes them suitable only in well-controlled environments with simple geometries and limited multipath [10]–[12].

Precise signal AOA measurements can be obtained using antenna arrays with sufficiently narrow beams. By combining at least 2 AOA measurements or one AOA and one range measurement it is possible to determine the position of the tag. To achieve high angle resolutions, AOA schemes require large antenna arrays to realize narrow beams with consequent large dimension of readers and high cost of the infrastructure [13].

Due to all these limitations, a technology change is required in order to provide enhanced localization performance while preserving system complexity and low cost. In the following we focus on the impact of the joint adoption of UWB and RFID technologies to overcome such limitations.

III. ULTRA-WIDEBAND RFID

A. The UWB Technology

According to the FCC definition published on Feb./2002, each signal characterized by a bandwidth larger than 500 MHz is considered UWB regardless the way it is generated. The classical and simplest method to obtain UWB signals is by means of impulse radio UWB (IR-UWB). In an IR-UWB system, a sequence of short pulses (typically with duration around 1 ns) per information bit is transmitted in order to collect more energy and allow multi-user access [14]. The short duration of pulses guarantees a fine resolution in the measurement of signal time-of-arrival (TOA) and multipath discrimination so that time-based localization algorithms can benefit to obtain accurate localization estimates. The UWB technology is currently utilized as baseline in high-performance short-range RTLS using battery-powered active tags according to the IEEE 802.15.4a and IEEE 802.15.4f standards as well as proprietary schemes [15].

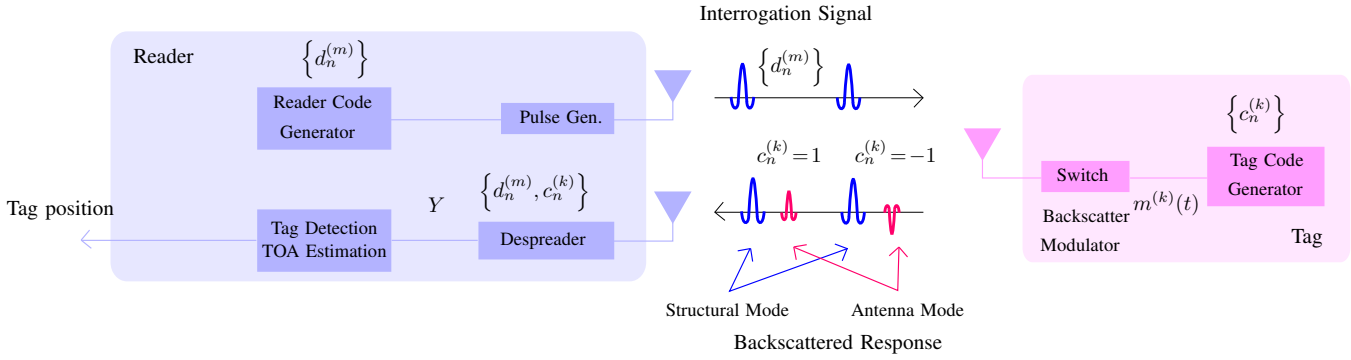

Fig. 3. UWB-RFID backscattering scheme.

B. UWB-RFID Solutions

Given the aforementioned potentialities, the joint use of RFID and UWB technologies represents a very appealing solution to fuse the advantages of RTLS and RFID. Several works and research projects have analyzed this option, especially considering active UWB-RFID schemes [16]–[18]. For example, in [16], [18] active reflectors at tag side are exploited to reinforce the backscattered signal. The strict constraints on energy consumption make solutions based on chipless and passive tags more appealing as proposed in [19]–[24]. Due to the longer operating range and better management of multiple tags, tag-reader communication performed through the modulation of the signal backscattered by the tag seems better suited for localization purposes than chipless implementations as it will be detailed in the next section.

C. The UWB Backscatter Principle

Backscatter modulation is based on the idea that the antenna reflection properties of the tag are changed according to information data. This principle is currently adopted in traditional passive UHF-RFID tags based on continuous wave (CW) signals to carry information from the tag to the reader. The same idea has been proposed in [19] using UWB interrogation signals instead of CW signals to exploits the benefits offered by UWB in terms of TOA measurement resolution.

With reference to Fig. 3, when a train of UWB pulses is transmitted and encounters the antenna of the tag, it is partially reflected back depending on antenna configuration. The backscattered response consists of structural and antenna scattering modes which are plotted separately in figure for convenience. The structural mode occurs owing to the antenna's given shape and material and is independent from how the antenna is loaded. On the other side, antenna scattering mode is a function of the antenna load; when connected to a short circuit, the backscattered pulse is characterized by a sign inversion with respect to the open load condition. This property can be exploited to establish a communication link between the tag and the reader. Moreover, by estimating the round-trip time (RTT) of the reflected signal, by measuring its TOA with respect to the interrogation signal timing, it is possible to infer the distance between the reader and the

tag with high accuracy. Unfortunately, signals scattered by the surrounding environment (clutter) as well as the antenna structural mode dominate the signal received by the reader, thus making the detection of the antenna mode component (which carries data) a main issue in passive UWB-RFID.

As a consequence a proper design of the signaling scheme, as that suggested in [19] becomes necessary. In particular, consider the following interrogation signal, composed of a coded sequence of UWB pulses $p(t)$, which is emitted by the m th reader

$$s(t) = \sum_{n=0}^{N_c-1} d_n^{(m)} p(t - n T_c) \quad (1)$$

where T_c is the chip time or pulse repetition period, $\{d_n^{(m)}\}$, $n = 0, 1, \dots, N_c - 1$, is the (spreading) bipolar code identifying the m th reader with length N_c .

Once activated, the backscatter modulator in the tag starts switching the antenna load between open and close circuit at each chip time T_c according to the modulating signal²

$$m^{(k)}(t) = \sum_{n=0}^{N_c-1} c_n^{(k)} \Pi(t - n T_c) \quad (2)$$

which depends on the tag's bipolar code $\{c_n^{(k)}\}$, for $n = 0, 1, \dots, N_c - 1$, being $\Pi(t) = 1$ for $t \in [0, T_c]$ and 0 elsewhere. As a consequence, the polarity of the reflected signal (antenna mode) changes at each chip time according to the k th tag's code $\{c_n^{(k)}\}$

$$\begin{aligned} s_b^{(k)}(t) &= \left(s(t) \otimes h^{(k)}(t) \right) \cdot m^{(k)}(t) \\ &= \sum_{n=0}^{N_c-1} d_n^{(m)} c_n^{(k)} p(t - n T_c) \otimes h^{(k)}(t - n T_c), \end{aligned} \quad (3)$$

where $h^{(k)}(t)$ is the channel impulse response related to the m th reader- k th tag link. This operation ensures the creation of a unique backscattered signal signature allowing the discrimination of the k th tag among other tags (generating the multi-tag interference) and clutter.

²For the sake of explanation, we suppose the clock of the tag is synchronous with that of the reader.

The signal backscattered by the tag propagates back to the reader's antenna through the tag-reader link giving

$$\begin{aligned} r(t) &= s_b^{(k)}(t) \otimes h^{(k)}(t) + \sum_{n=0}^{N_c-1} d_n^{(m)} w_C(t - nT_c) + n(t) \\ &= \sum_{n=0}^{N_c-1} d_n^{(m)} c_n^{(k)} w(t - nT_c) + \sum_{n=0}^{N_c-1} d_n^{(m)} w_C(t - nT_c) + n(t) \end{aligned} \quad (4)$$

where $n(t)$ is the additive white Gaussian noise (AWGN), $w(t) = h^{(k)}(t) \otimes h^{(k)}(t) \otimes p(t)$ is the reader-tag-reader channel response to $p(t)$ (antenna mode only), and $w_C(t)$ is the clutter obtained from each emitted pulse. Note that the useful received signal is the result of double convolution of the interrogation signal with the one-way channel impulse response $h^{(k)}(t)$. As can be noticed in (4), the first component appears as a UWB sequence spread using the combined code $\{d_n^{(m)} c_n^{(k)}\}$, whereas the second term representing the clutter appears as a UWB sequence spread using the reader's code $\{d_n^{(m)}\}$. This difference allows the discrimination between the useful signal coming from the k th tag and the clutter as well as from the interference generated by other tags. In fact, if at the receiver the signal is de-spread using the combined code $\{d_n^{(m)} c_n^{(k)}\}$ (see Fig. 3) and the tag code $\{c_n^{(k)}\}$ is designed so that it is balanced, then clutter can be (in principle) removed. In particular, the de-spreading operation consists in correlating the incoming signal with a local template $s_0(t)$ obtained using the combined code $\{d_n^{(m)} c_n^{(k)}\}$

$$s_0(t) = \sum_{n=0}^{N_c-1} d_n^{(m)} c_n^{(k)} w(t - nT_c). \quad (5)$$

In the presence of the k th tag, at the output of the correlator it is

$$\begin{aligned} Y &= \int_0^{(N_c-1)T_c} r(t) \cdot s_0(t) dt \\ &= N_c E_w + E_w \sum_{n=0}^{N_c-1} d_n^{(m)} c_n^{(k)} d_n^{(m)} + Z \\ &= N_c E_w + Z \end{aligned} \quad (6)$$

since $d_n^{(m)} d_n^{(m)} = 1 \forall n$, $\sum_{n=0}^{N_c-1} c_n^{(k)} = 0$ by design, and where E_w is the energy of $w(t)$ and Z is the thermal noise at the output of the de-spreader. From (6) one can note that the presence of the k th tag can be detected if the intensity $N_c E_w$ of the useful signal at the output of the despreader is sufficiently high with respect to the thermal noise Z . The receiver complexity derived from the need to estimate the channel impulse response, and hence $w(t)$ in (5), can be significantly alleviated by resorting to partial-coherent receivers [25].

This basic protocol can be easily extended by including data payload in the backscattered signal [19]. Notice that when

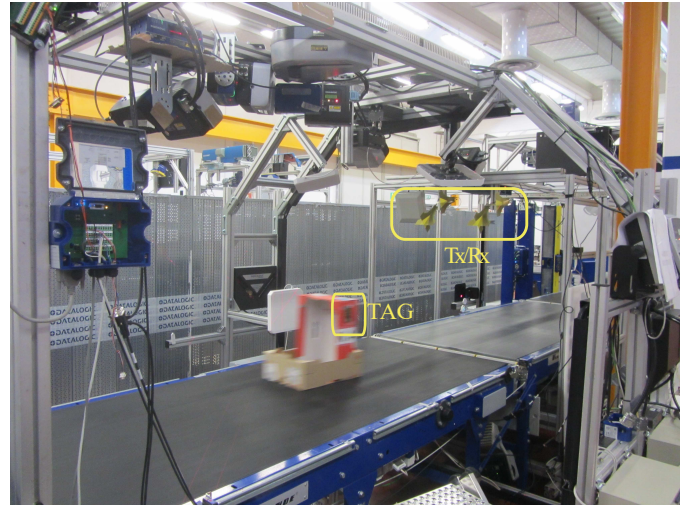

Fig. 4. Luggage sorting on a conveyor belt using UWB-RFID tags [25].

the same tag is interrogated by at least 3 readers located in known positions, 3 reader-tag distances are directly computed from the signal RTT and the tag can be localized (in 2D) without ambiguity by means of multi-lateration techniques [6]. In addition, a proper code design allows simultaneously interrogations of multiple tags [24].

D. Implementations of UWB-RFID Systems

The basic passive communication and ranging scheme illustrated in the previous section is based on some simplifying assumptions that are not met in real scenarios. In practical implementations the following issues have to be addressed:

- *Poor link budget* - Because of the two-way link, the path-loss can be severe and only partially compensated by increasing the transmission power because of the conservative regulation limitations in the UWB band. As can be seen in (6), the signal-to-noise ratio (SNR) can be improved by increasing the number N_c of pulses associated to each interrogation signal at the expense of a longer identification time.
- *Lack of synchronism* - Tags are passive devices so no front-end is present in the receiver to extract synchronization information from the UWB interrogation signal. The main consequence is that tags are completely asynchronous. This problem can be solved by a proper design of the code and the introduction of side synchronization signals (e.g., in the UHF band) to provide a coarse synchronization, as it will be explained later [26]. To facilitate code acquisition at the receiver in [24] (quasi)-orthogonal codes allowing multiple tags operating simultaneously with limited reciprocal interference have been investigated.
- *Energy supply* - Although UWB backscattering is characterized by an extremely-low power consumption since only the UWB switch is required to perform signal modulation, the circuitry at tag side (control logic in addition to the UWB switch) must be properly powered so that

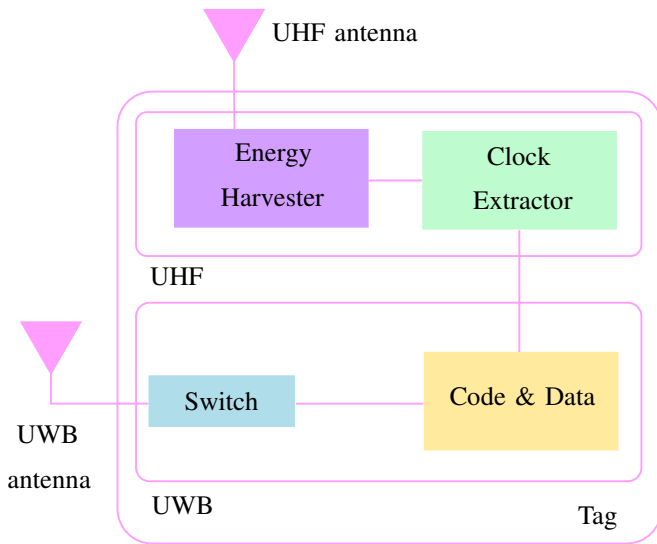

Fig. 5. UWB-RFID tag with energy harvesting in the UHF band.

some limited source of energy (e.g., harvested from the environment) is needed. Due to the impossibility to extract significant energy from the UWB link because of regulatory issues, a solution is to exploit the UHF band to transfer the required energy to the tag as done in Gen.2 RFID [26].

The above mentioned issues have been tackled in some research projects leading to prototypes providing proof-of-concept of the UWB-RFID technology. An example of implemented UWB-RFID system realized in the context of the EU project SELECT for precise luggage sorting in airports is depicted in Fig. 4 [25]. To simplify the processing at the reader side, a partially coherent receiver has been designed as a trade-off between complexity and ranging performance. In this set up it was demonstrated that it is possible to detect and sort tags up to distances of 4.5 m, with errors within 30 cm.

In the context of the Italian project GRETA, the energy efficiency and eco-compatibility aspects of UWB-RFID systems have been investigated [26], [27]. Coexisting UHF and UWB interrogation signals have been considered to transfer the energy to the tag and provide some synchronization reference. In Fig. 5 an example of tag architecture is reported in which the energy necessary to wake-up the tag, power the control logic and the UWB backscatter modulator is harvested from the UHF link. The synchronization signal can be obtained by modulating the amplitude of the UHF carrier with a periodic square wave having period T_c which timing is extracted by the clock extractor and used to drive the code generator. A simpler alternative method is to synchronize the code generator at the falling edge of the UHF wake-up signal [26]. In this case a local clock generator must be included in the tag and clock drifts have to be properly managed at the reader.

Due to the coexistence of UHF and UWB bands and to reduce tag's dimensions, a dedicated dual band antenna has been designed as shown in Fig. 6 [28]. Such an antenna provides

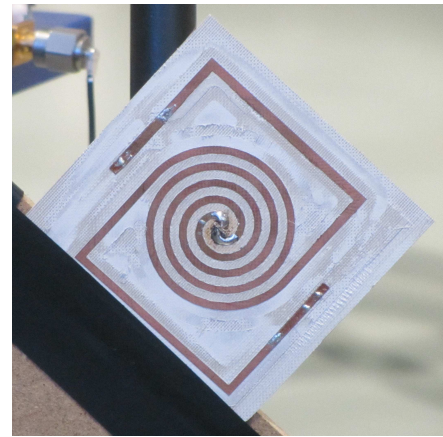

Fig. 6. Single port UHF/UWB antenna prototype on paper substrate [28].

quite good performance also in the UWB band considering it is built on paper-based substrate. Experimental characterizations have demonstrated the possibility to reach up to 6 m with 15 cm ranging accuracy in backscattering configuration. In [26] other possible architectures are discussed including those in which the UWB link is exploited only for ranging and localization purposes while the UHF part is composed of a standard Gen.2 UHF tag for backward compatibility.

IV. OPEN ISSUES AND FUTURE PERSPECTIVES

A. Main Challenges

Despite the recent progresses obtained, the UWB-RFID technology is not mature yet for a widespread adoption in context-aware applications. In fact, several aspects, most of them in common with UHF RFID, have to be addressed to make it an appealing and users-accepted solution.

The most critical one is related to energy efficiency; in fact when a tag is interrogated only about 1% of the energy emitted by the reader is captured by the tag while the remaining 99% is wasted in the environment. In addition to the scarce power transfer efficiency, the localization of tags still requires ad-hoc devices and costly infrastructures that makes the integration of RFID readers in future smartphones not feasible yet. Associated to the low power transfer efficiency, the limited reading range (less than 10 meters) obliges the deployment of a network of dense readers to localize and track items in large areas (e.g., in stores). Backward compatibility with Gen.2 RFID is another important aspect that might significantly condition the market acceptance of new technologies. Last but not least, the potential introduction of billions of tags should be sustainable from an eco-compatibility point of view, in other words, tags should be disposable, which is in contrast with the need of high performance electronic circuits to manage UWB signals.

B. Future Perspectives

One of the key technologies for future RFID is represented by millimeter waves (mmW) and, more in perspective, by the

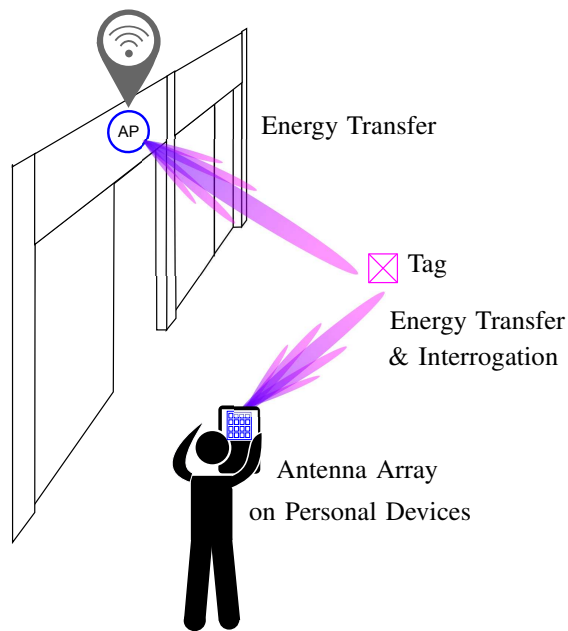

Fig. 7. Energy transfer mechanism to energize passive tags using mmW/THz massive antenna arrays.

THz band [29]. The incoming fifth generation (5G) smartphones will integrate mmW interfaces to boost the communication data rate beyond 1 Gbps. A part from the extremely large bandwidth available at such frequencies, which is beneficial for accurate positioning, mmW technologies offer also other interesting opportunities.

First of all, the small signal wavelength (5 mm at 60 GHz) allows to pack hundreds of antenna elements in a small area, even integrable into smartphones. An example of existing 400-elements array is given by [30]. Such large number of antenna elements permits to realize a near-pencil beam that is electronically steerable. Thanks to the extremely narrow beam formed, the possibility to focus the power flux towards the tag and transfer the energy at several meters will become possible with much higher efficiency than that achievable with today's technology. Therefore there will be the possibility to energize, detect and localize tagged items using smartphones at several meters of distance enabling augmented reality applications. Moreover, no dedicated infrastructure would be required as large antenna arrays already used for communication could be employed as reference nodes with the advantage of permitting both accurate TOA and AOA estimates (see Fig. 7).

In another possible scenario, access points deployed for indoor communications and equipped with mmW antenna arrays localize the tags present in the surrounding environment, and focus the beam to allow the tag to accumulate the energy (e.g., during the night) so that they will be operative whenever a mobile device interrogates them, as shown in Fig. 7 [31]. Efficient and smart energy transfer together with high-performance energy accumulation (e.g., using supercaps [32]) could open the possibility to exploit efficient active communications (active tags) in place of backscatter commu-

nication.

As previously stated, tags have to be eco-compatible. In such a context, the use of paper for the implementation of microwave components and systems is receiving an increasing attention, as it is a cheap, renewable and biocompatible material [27]. Among the available technologies for the manufacturing and integration of microwave components, the substrate integrated waveguide (SIW) technique is a potential candidate to deal with high frequency and UWB signals [33].

In conclusion, in this survey we have highlighted that a technological shift is essential to satisfy the demanding requirements of future IoT systems offering high-accuracy localization. UWB-RFID is a promising candidate in this direction because it conjugates the high-resolution discrimination of UWB signals with the backscatter principle of passive RFID. However, for its widespread adoption as next-generation RFID, a significant research effort and synergy between different but tightly intertwined fields such as low-power electronics, antenna design, communication theory and signal processing, is required.

ACKNOWLEDGMENT

This work has been funded in part by the European H2020 project XCycle (Grant 635975), the GRETA project (Grant 2010WHYSPR) funded by the Italian Minister of Research, and the H2020-EU.1.3.2 IF-EF Marie Curie action MAPS (Grant 659067).

The authors wish to thank R. D'Errico and all the partners of the GRETA and SELECT projects for the fruitful cooperation.

REFERENCES

- [1] K. Finkeneller, *RFID Handbook: Fundamentals and Applications in Contactless Smart Cards and Identification.*, 3rd ed. Wiley, 2010.
- [2] D. Zhang *et al.*, "Real-time locating systems using active RFID for Internet of Things," *IEEE Syst. J.*, no. 99, pp. 1–10, 2014.
- [3] A. Costanzo *et al.*, "Tag, you're it: Ranging and finding via RFID technology," *IEEE Microw. Mag.*, vol. 14, no. 5, pp. 36–46, Aug. 2013.
- [4] D. Van Krevelen and R. Poelman, "A survey of augmented reality technologies, applications and limitations," *International Journal of Virtual Reality*, vol. 9, no. 2, p. 1, 2010.
- [5] R. Verdone *et al.*, *Wireless sensor and actuator networks: technologies, analysis and design.* Academic Press, 2010.
- [6] D. Dardari, P. Closas, and P. M. Djuric, "Indoor tracking: Theory, methods, and technologies," *IEEE Trans. Veh. Technol.*, vol. 64, no. 4, pp. 1263–1278, April 2015.
- [7] D. Arnitz, U. Muehlmann, and K. Witrisal, "Characterization and modeling of UHF RFID channels for ranging and localization," *IEEE Trans. Antennas Propag.*, vol. 60, no. 5, pp. 2491–2501, May 2012.
- [8] D. Arnitz, K. Witrisal, and U. Muehlmann, "Multifrequency continuous-wave radar approach to ranging in passive UHF RFID," *IEEE Trans. Microw. Theory Tech.*, vol. 57, no. 5, pp. 1398–1405, May 2009.
- [9] Z. Zhang *et al.*, "Item-level indoor localization with passive UHF RFID based on tag interaction analysis," *IEEE Trans. Industrial Electron.*, vol. 61, no. 4, pp. 2122–2135, Apr. 2014.
- [10] P. Nikitin *et al.*, "Phase based spatial identification of UHF RFID tags," in *Proc. IEEE Int. RFID Conf.*, Orlando, FL, Apr. 2010, pp. 102–109.
- [11] R. Miesen, F. Kirsch, and M. Vossiek, "UHF RFID localization based on synthetic apertures," *IEEE Trans. Autom. Science and Engineering*, vol. 10, no. 3, pp. 807–815, 2013.
- [12] E. DiGiampaolo and F. Martinelli, "Mobile robot localization using the phase of passive UHF RFID signals," *IEEE Trans. Ind. Electron.*, vol. 61, no. 1, pp. 365–376, 2014.
- [13] <http://www.impinj.com/products/gateways/xarray-gateway/>.

- [14] M. Win *et al.*, "History and applications of UWB," *Proc. IEEE*, vol. 97, no. 2, pp. 198–204, Feb. 2009.
- [15] Z. Sahinoglu, S. Gezici, and I. Guvenc, *Ultra-Wideband Positioning Systems: Theoretical Limits, Ranging Algorithms, and Protocols*. Cambridge University Press, 2008.
- [16] D. Dardari, "Pseudo-random active UWB reflectors for accurate ranging," *IEEE Commun. Lett.*, vol. 8, no. 10, pp. 608–610, Oct. 2004.
- [17] M. Baghaei-Nejad *et al.*, "A remote-powered RFID tag with 10Mb/s UWB uplink and 18.5dBm sensitivity UHF downlink in 0.18 CMOS," in *IEEE Int. Solid-State Circuits Conference (ISSCC)*, Feb. 2009, pp. 198–199.
- [18] A. Lazaro *et al.*, "Active UWB reflector for RFID and wireless sensor networks," *IEEE Trans. Antennas Propag.*, vol. 61, no. 9, pp. 4767–4774, Sep. 2013.
- [19] D. Dardari *et al.*, "Ultrawide bandwidth RFID: The next generation?" *Proc. IEEE*, vol. 98, no. 9, pp. 1570–1582, Sep. 2010.
- [20] D. Arnitz, U. Muehlmann, and K. Witrissal, "UWB ranging in passive UHF RFID: Proof of concept," *IEEE Electronics Lett.*, vol. 46, no. 20, pp. 1401–1402, Oct. 2010.
- [21] Z. Zou *et al.*, "Design and demonstration of passive UWB RFIDs: Chipless versus chip solutions," in *IEEE Int. Conf. on RFID-Technologies and Applications (RFID-TA)*, Nice, France, Nov. 2012, pp. 6–11.
- [22] A. Ramos, A. Lazaro, and D. Girbau, "Semi-passive time-domain UWB RFID system," *IEEE Trans. Microwave Theory Tech.*, vol. 61, no. 4, pp. 1700–1708, Apr. 2013.
- [23] F. Guidi *et al.*, "Analysis of UWB tag backscattering and its impact on the detection coverage," *IEEE Trans. Antennas Propag.*, vol. 62, no. 8, pp. 4292–4303, Aug. 2014.
- [24] —, "Detection of multiple tags based on impulsive backscattered signals," *IEEE Trans. Commun.*, vol. 62, no. 11, pp. 3918–3930, Nov. 2014.
- [25] —, "A low complexity scheme for passive UWB-RFID: Proof of concept," *IEEE Comm. Lett.*, 2016, to appear.
- [26] N. Decarli, F. Guidi, and D. Dardari, "Passive UWB RFID for tag localization: Architectures and design," *IEEE Sensors J.*, vol. 16, no. 5, pp. 1385–1397, Mar. 2016.
- [27] N. Decarli *et al.*, "The GRETA architecture for energy efficient radio identification and localization," in *Proc. Int. EURASIP Workshop on RFID Tech. (EURFID)*, Oct 2015, pp. 1–8.
- [28] M. Fantuzzi, D. Masotti, and A. Costanzo, "A novel integrated UWB-UHF one-port antenna for localization and energy harvesting," *IEEE Trans. Antennas Propag.*, vol. 63, no. 9, pp. 3839–3848, Sep. 2015.
- [29] P. Pursula *et al.*, "Millimeter-wave identification - a new short-range radio system for low-power high data-rate applications," *IEEE Trans. Microw. Theory Tech.*, vol. 56, no. 10, pp. 2221–2228, 2008.
- [30] H. Kaouach *et al.*, "Wideband low-loss linear and circular polarization transmit-arrays in V-band," *IEEE Trans. Antennas Propag.*, vol. 59, no. 7, pp. 2513–2523, Jul. 2011.
- [31] A. Guerra *et al.*, "Energy sprinklers for passive UWB RFID," in *Proc. IEEE Int. Conf. on Ultra-Wideband (ICUWB)*, Paris, France, Sep. 2014, pp. 1–6.
- [32] S. Sudevalayam and P. Kulkarni, "Energy harvesting sensor nodes: Survey and implications," *IEEE Commun. Surveys & Tutorials.*, vol. 13, no. 3, pp. 443–461, 2011.
- [33] S. Moscato *et al.*, "Compact substrate integrated waveguide (SIW) components on paper substrate," in *45th European Microwave Conference (EuMC)*, Paris, France, Sep. 2015.