

This is the final peer-reviewed accepted manuscript of:

“Assessing the Role of Counterion in Gold-Catalyzed Dearomatization of Indoles with Allenamides by NMR Studies”

Rocchigiani, Luca; Jia, Minqiang; Bandini, Marco; Macchioni, Alceo

ACS CATALYSIS. 2015, 5, 3911–3915

The final published version is available online at:
<http://dx.doi.org/10.1021/acscatal.5b00502>

Rights / License:

The terms and conditions for the reuse of this version of the manuscript are specified in the publishing policy. For all terms of use and more information see the publisher's website.

This item was downloaded from IRIS Università di Bologna (<https://cris.unibo.it/>)

When citing, please refer to the published version.

Assessing the Role of Counterion in Gold Catalyzed Dearomatization of Indoles with Allenamides by NMR Studies

Luca Rocchigiani,[†] Minqiang Jia,[‡] Marco Bandini,^{*,‡} and Alceo Macchioni^{*,†,#}

[†]Department of Chemistry, Biology and Biotechnology, University of Perugia and CIRCC, Via Elce di sotto, 8, I-06123 Perugia, Italy.

[‡]Department of Chemistry "G. Ciamician", Alma Mater Studiorum – University of Bologna, Via Selmi 2, I-40126 Bologna, Italy. [#]Istituto di Scienze e Tecnologie Molecolari del CNR (CNR-ISTM), c/o Department of Chemistry, Biology and Biotechnology, University of Perugia, I-06123, Perugia, Italy

Supporting Information Placeholder

ABSTRACT: The counterion effect in the gold(I)-catalyzed dearomative condensation of indoles with allenamides is unveiled by means of 1D and 2D-NMR investigation. The different coordination ability and hydrogen bonding tendency of TFA⁻ and OTf⁻ led to specific interactions with the reaction partners dictating the regiodivergent outcome. **KEYWORDS:** gold, NMR spectroscopy, anion effect, mechanism, weak interactions, homogeneous catalysis

The counterion is of critical importance in stoichiometric and catalytic reactions of ionic transition metal complexes.¹ While the number of examples in which the role of counterion is key continuously increases,² the rationalization of the counterion action is somewhat hampered usually due to complicate kinetics and to the lack of structural information concerning with the localization of the counterion with respect to the ionic metal complex. About twenty years ago³ we suggested that NOE NMR interionic studies could be exploited to obtain information on the ion pair structure of ionic transition metal complexes and to correlate the latter with their reactivity.⁴ Such a methodology revealed particularly successful and was applied, often in combination with diffusion NMR,⁵ to provide deeper insights into several important reactions, including olefin polymerization and copolymerization,⁶ C–H activation⁷ and small molecule activation by frustrated Lewis pairs.⁸

Among the classes of ionic transition metal complexes successfully used in catalysis, gold(I) linear complexes of general formula [L–Au–S]X (where L = ancillary ligand, S = substrate or solvent, X⁻ = counterion) are assuming particular importance, especially as far as the activation of unsaturated substrates is concerned.⁹ Also for such complexes X⁻ plays a critical role,¹⁰ which, in some cases, has been elegantly eluci-

dated by combining NMR, kinetics and theoretical approaches.¹¹

Some of us have very recently documented on the role of counterion for the dearomatization of indoles¹² as a consequence of their reaction with allenamides catalyzed by [{2,4-(^tBu)₂C₆H₃O}₃P–Au–X] (1X).¹³ In particular, it has been shown that the regioselectivity of 2,3-dimethyl-1H-indole (**2**) and *N*-tosyl-*N*-phenyl-allen-1-amine (**3**) reaction is dramatically affected by the selection of X⁻ (Scheme 1).¹⁴ More precisely, while a nucleophilic attack of N(1) at **3** occurs when X⁻ = OTf⁻ (OTf⁻ = triflate, CF₃SO₃⁻), as expected for 2,3-disubstituted indoles,¹⁵ an unusual C(3) attack at **3** takes place when X⁻ = TFA⁻ (TFA⁻ = trifluoroacetate, CF₃COO⁻, Scheme 1).

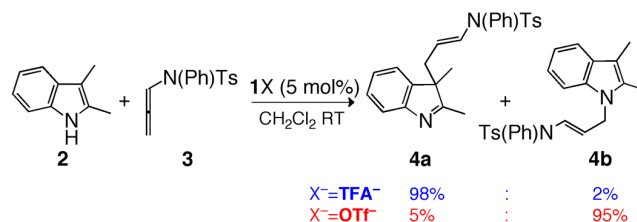

Scheme 1. Gold-catalyzed dearomatization of indole **2 with allenamide **3**.**

In order to assess the role of X⁻ in directing the reaction reported in Scheme 1 and, in particular, rationalize why TFA⁻ and OTf⁻ provide almost opposite regioselectivity, anion/substrates competitive NMR experiments and *in situ* kinetics were performed and the results are reported herein.

1X exhibited a notably different reactivity with **2** when X⁻ = TFA⁻ and OTf⁻. The NMR spectra of a mixture of 1TFA and 1.5 equivalents of **2**, in anhydrous methylene chloride-*d*₂, appeared as the sum of the individual spectra of the components in the same solvent, indicating that 1TFA and **2** were not strongly interacting. This was further confirmed by

diffusion NMR experiments, which showed an independent self-translation motion of **1TFA** and **2** in solution. A sensible broadening of both ^{19}F and ^{31}P NMR signals was observed by increasing the amount of indole (Supporting Information). When the temperature was lowered down to 233 K, the ^{19}F NMR spectrum resolved in two sharp signals at $\delta_{\text{F}} = -74.2$ and -76.0 ppm having a 60:40 ratio. ^{31}P NMR showed the presence of a principal species at $\delta_{\text{P}} = 87.8$ ppm plus minor species at about 97.0 ppm (ca. 80:20 ratio). ^1H NMR spectrum remained substantially the same. Both ^{31}P and ^{19}F chemical shift value of the most abundant species is consistent with that of the starting inner sphere **1TFA**. Because the second TFA signal at -76.0 ppm is too intense to account only for outer sphere TFA^- anion belonging to minor gold species, it can be suggested that traces of trifluoroacetic acid, whose signal could be in rapid exchange with that of the anion, formed, likely due to adventitious water.^{11c} Consequently, a fraction of minor species could have a counterion different from TFA^- , such as $\text{OH}^- \cdot \text{TFA}^-$ at $\delta_{\text{F}} = -74.2$ ppm showed selective dipolar interactions with both signals due to phosphite ligand and indole in the ^{19}F , ^1H HOESY NMR spectrum recorded at 233K (Figure 1). In particular, NH and methyl groups in α to the nitrogen atom showed rather strong interactions with the CF_3 moiety of TFA^- , suggesting that hydrogen bonding interactions between an inner sphere anion and base were established (Figure 1).

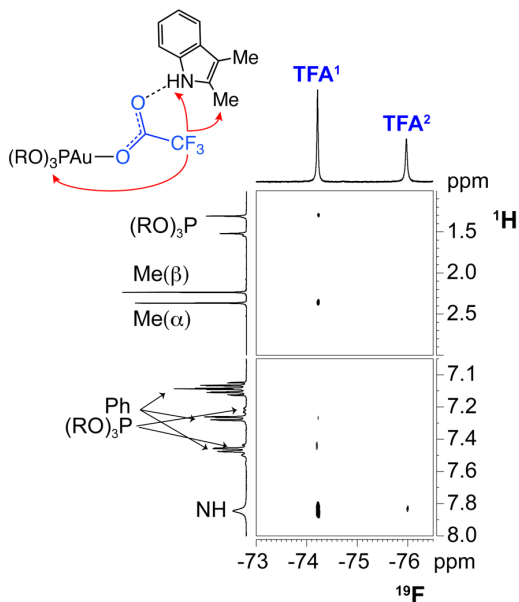
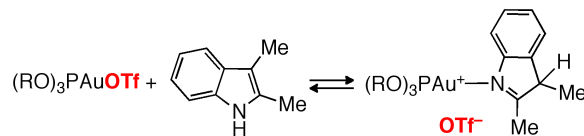

Figure 1. ^{19}F , ^1H HOESY NMR spectrum of a mixture containing **1TFA** and 15 equivalents of **2** (methylene chloride- d_2 , 233K); red arrows denote NOE interactions.

The second TFA^- signal shows a weak interaction with the NH group in the ^{19}F , ^1H HOESY NMR spectrum (Figure 1), suggesting that also outer sphere TFA^- anion establishes hydrogen bonding with **2**, even if the presence of transferred NOE cannot be ruled out.¹⁶ The picture emerging is that **2** does not displace easily TFA^- anion from the first coordina-

tion sphere of Au and only a minor fraction of outer sphere ion pairs is formed. In both types of complexes, the presence of an hydrogen bond donor moiety stimulates the interaction with **2** in a manner which could be important for the catalytic dearomatization reaction.

When **1OTf** was reacted with an excess of **2** (ca. 2.5 equivalents), a fast reaction took place and a new signal at $\delta_{\text{P}} = 97.3$ ppm was detected in the $^{31}\text{P}\{^1\text{H}\}$ NMR spectrum. ^1H NMR spectroscopy revealed the formation of a new set of signals, featuring a quartet at $\delta_{\text{H}} = 4.0$ ($J_{\text{H,H}} = 7.9$ Hz), a singlet at $\delta_{\text{H}} = 2.46$ and a doublet at $\delta_{\text{H}} = 1.54$ ($J_{\text{H,H}} = 7.9$ Hz), while ^{19}F NMR indicated that the resonance due to the anion shifted from $\delta_{\text{F}} = -77.7$ to $\delta_{\text{F}} = -78.8$ ppm. By crossing all the pieces of information coming from 1D and 2D NMR, it is possible to conclude that **2** displaces **OTf** from the first coordination sphere of **1OTf** and coordinates at the gold centre through the nitrogen atom. Moreover, a 1,3-proton shift occurs thus leading to the dearomatization of the coordinated indole (indolenine core, Scheme 2). Such a coordination/isomerization of **2** at the gold centre showed to be a reversible process, since exchange cross peaks involving free 1H-indole and coordinated 3H-indole were observed in the ^1H NOESY NMR spectrum (Supporting Information). The ^{19}F , ^1H HOESY NMR spectrum of the reaction product (Supporting Information) indicated that the outer sphere OTf^- anion has selective dipolar contacts with the resonances of the phosphite ligand and the methyl group in α position to the nitrogen atom, suggesting that a close Au-anion interaction is present.



Scheme 2. Reactivity of **1OTf** with **2**.

The elucidation of the reactivity of **1X** complexes with allenamide **3** is far more complicated due to collateral reactions arising from the presence of water traces into the reaction environment.¹⁷ Upon mixing **1TFA** with **3** (1.5-15 equivalents), in anhydrous methylene chloride- d_2 at 233 K, allene was quantitative converted into an olefinic product formally derived from the addition of a trifluoroacetic acid molecule at **3** (**5**, Scheme 3). At the same time, the majority of the gold complex was converted into a new neutral species **6** featuring an acrolein moiety σ -bonded to the gold centre via the C(2) atom (Scheme 3),¹⁸ stemming from the hydrolysis of the allene scaffold.

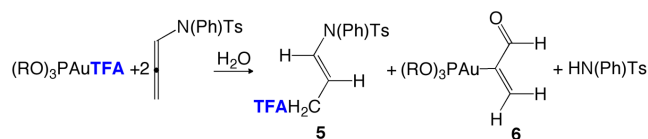

Scheme 3. Proposed deactivation pathway of [Au(I)]-allene species in the presence of traces of H₂O.

Due to this complication coming from adventitious traces of water, a series of *in situ* NMR reactivity experiments of **1X** with **3** was carried out with rigorous exclusion of water and oxygen by means of high-vacuum Schlenk techniques (Supporting Information). When 1TFA was mixed with 1.5 equivalents of **3** in dry methylene chloride-*d*₂ at 233 K, the ¹H NMR spectrum of the mixture showed the presence of two sets of signals for both phosphite ligand and allene (Supporting Information). On the other hand, three singlets, located at δ_F = -73.5 (broad), δ_F = -74.3 and δ_F = -75.0 ppm, were observed in the ¹⁹F spectrum and three signals resonating at δ_P = 139.6, δ_P = 130.1 and δ_P = 87.8 ppm were found in the ³¹P{¹H} spectrum, suggesting that three species might be present in solution. The latter ³¹P signal was straightforwardly assigned to unreacted 1TFA, which accounts for the 30% of the mixture, indicating that **3** does not displace easily TFA⁻ anion from the first coordination sphere of gold. The nature of the other two species **7** and **8** was ascertained by means of ¹H, ³¹P HMBC, ¹⁹F, ¹H HOESY and ¹⁹F NOESY NMR spectroscopies. In particular, both the signals at δ_P = 139.6 and δ_P = 130.1 ppm showed weak long-range scalar correlations in ¹H, ³¹P HMBC with the broad signal at δ_H = 4.83 ppm (Supporting Information), indicating that both **7** and **8** bear the Au-allene moiety. Importantly, the ¹⁹F NOESY spectrum revealed that the resonance at δ_F = -73.6 due to **8** is in selective chemical exchange with the resonance of 1TFA (Figure 2), strongly suggesting that also **8** is an inner sphere ion pair. Because ¹H, ³¹P HMBC indicates that **3** is also coordinated, **8** has to be formulated as a tricoordinated isip (inner sphere ion pair, Scheme 3).¹⁹

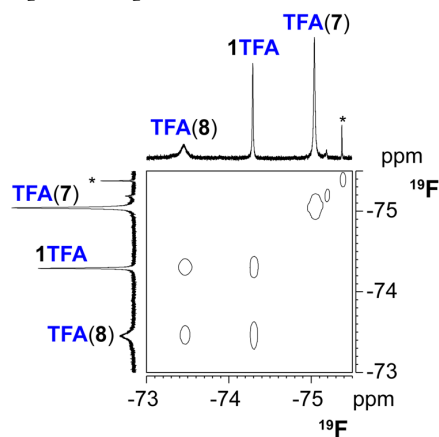
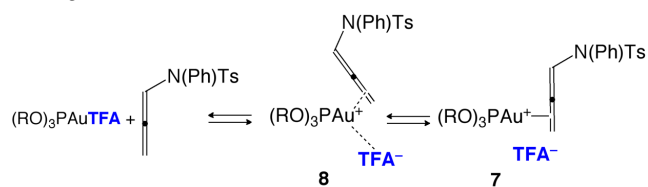

Figure 2. ¹⁹F NOESY NMR spectrum of a mixture containing 1TFA and 1.5 equivalents of **3** (dry methylene chloride-*d*₂, 233K); asterisk denotes traces of **5**.

Attempts to generate a higher concentration of **8** were carried out by increasing the amount of **3** up to 8 equivalents. 1TFA was consumed quantitatively, nevertheless the relative concentration of **8** was not sensibly increased as that of **7**,

suggesting that a steady state concentration of **8** accumulates during **7** formation.



Scheme 4. Proposed reactivity between 1TFA and **3** in dry methylene chloride-*d*₂ at 233K.

Consequently, **7** is likely the osip (outer sphere ion pair) derived from the complete displacement of TFA⁻ by **3**.²⁰ NMR parameters are consistent with this hypothesis given that the ¹⁹F resonance falls at a lower value of chemical shift, since the anion is more negatively charged, and the ³¹P resonance of **7** falls at a higher chemical shift value than that of **8**, due to the smaller amount of electron density at gold. Another hint to the osip nature of **7** comes from the HOESY spectrum (Supporting Information), which showed that the fluorine signal had rather strong dipolar interactions with phosphite ligand signals and two broad signals located at δ_H = 4.83 and δ_H = 6.71 ppm, which were assigned to **3** coordinated at the gold centre through the terminal double bond. The signal at δ_F = -73.6 of **8** was too broad to give observable NOEs with protons.

It is interesting to outline that, according to the ¹⁹F NOESY experiment, i) association/dissociation of **3** is faster than association/dissociation of TFA⁻ and ii) displacement of TFA⁻ from gold by **3** occurs through an associative mechanism.

When 1OTf was combined with 2 equivalents of **3** in dry methylene chloride-*d*₂ at 233 K, ¹H NMR spectroscopy indicated that outer sphere ion pairs featuring gold-allene interactions could not be intercepted due to a rapid collateral reaction that consumed all the substrate. Multinuclear and multidimensional NMR studies revealed that **3** quickly dimerized to form disubstituted cyclobutanes (Supporting Information), as previously observed by González.²¹ The reaction was found to be catalytic since consecutive addition of **3** just increased the concentration of the product with no apparent modifications of the NMR spectra of 1OTf.

Finally, to contrast the behavior of 1TFA and 1OTf during the catalytic cycle, *in situ* NMR experiments were performed by using equimolar **2/3** mixtures and a catalyst loading of 5-8 mol%. The reactions were sufficiently slow to be monitored by NMR spectroscopy (Figure 3). Both in the cases of 1TFA and 1OTf, the first ¹H NMR spectrum recorded soon after mixing the reagents showed the presence of unreacted **2** and **3**. ³¹P{¹H} NMR revealed, instead, the formation of a main peak located at δ_P = 142.0 and δ_P = 140.5 ppm for TFA⁻ and OTf⁻, respectively, which likely indicated the formation of ion pairs featuring **3** in the first coordination sphere of gold.²²

Accordingly, ^{19}F NMR signals of the anions were lower frequency shifted by 1.7 and 1.4 ppm for TFA^- and OTf^- , respectively.

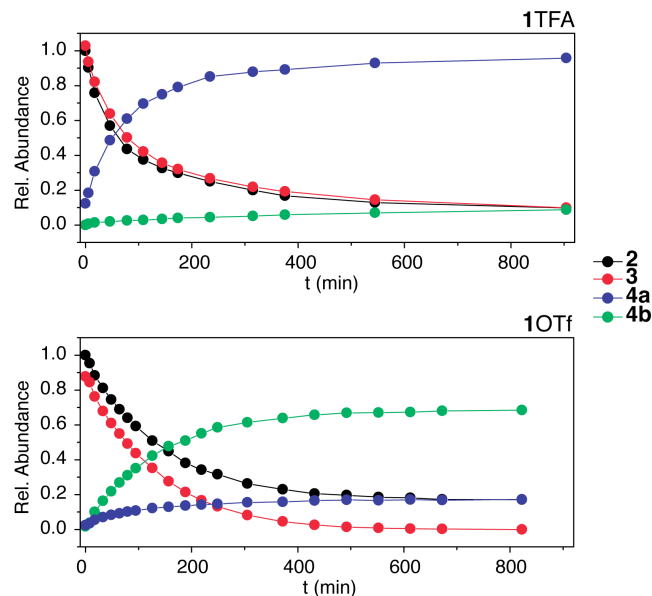

Figure 3. Kinetic profiles for the dearomatization reaction of **2** with **3** catalyzed by **1TFA** and **1OTf** (methylene chloride- d_2 , 298K).

From the kinetic point of view, both the reactions went to completion in about 12 hours to give the respective **4a/4b** mixture (Supporting Information), indicating that changing the counterion does not alter significantly the overall reaction rate. The concentration *versus* time trends of **2** and **3** showed to follow a biexponential decay, suggesting that both indole and allene play a role in the rate determining step. The estimation of the kinetic constants revealed that there is a quite similar kinetics for **4a** and **4b** formation, with a k_{4a}/k_{4b} ratio equal to 13.6 and 0.2 for **1TFA** and **1OTf**, respectively.

Monitoring the reaction mixture by ^{31}P NMR spectroscopy revealed that, in the case of **1TFA**, about one half of starting gold-alkene complex was slowly converted into different species during the course of the reaction, having main peaks at $\delta_{\text{p}} = 97.0$, 128.3 and 131.3 ppm. The first one can be assigned as a gold species featuring indole (or product) in the first coordination sphere, while the nature of the other two signals is unclear. It can be speculated that they belong to three coordinated species featuring TFA^- in the first coordination sphere of gold, given the similarity with the chemical shift of **8** (Supporting Information). When **1OTf** was used, the starting outer sphere ion pair was instead converted into a new species featuring a phosphite ligand resonating at $\delta_{\text{p}} = 96.9$ ppm, with a kinetics which is exactly the same of that of allene consumption. The similarity between the chemical shift value of the new complex and that of gold-3H-indole compound led us conclude that the catalyst is converted into

a gold complex featuring **4a** in the first coordination sphere. This hypothesis was supported by diffusion NMR, which showed that **4a** and **4b**, having in principle similar hydrodynamic volume values, diffused with different behavior. The observed difference in apparent hydrodynamic dimensions was perfectly in agreement with having the entire gold complex bound to **4a** (Supporting Information for details).

In conclusion, our results show that the difference in coordinating ability and hydrogen bonding tendency of TFA^- and OTf^- plays a remarkable role in driving the reactivity of $[\{2,4-(^t\text{Bu})_2\text{C}_6\text{H}_3\text{O}\}_3\text{P}-\text{Au}-\text{X}]$ (**1X**) with 2,3-dimethyl-1H-indole (**2**) and *N*-tosyl-*N*-phenyl-allen-1-amine (**3**). In particular, OTf^- anion is not competitive with both substrates for the coordination at the Au(I) center; as consequence, the reaction proceeds by the coordination of **3** at gold followed by the attack of **2** to coordinated **3** via N(1), the most nucleophilic site, leading to the expected **4b** regioisomer.¹⁴ On the contrary, TFA^- is so coordinating that its displacement from the first coordination sphere of gold occurs only by an excess of **3**. This process possibly leads to the formation of three-coordinated species **8**, successively evolving to osip **7**, in which the anion remains in close proximity to coordinated **3**. Despite **2** is not basic enough to replace the anion, low-temperature NOE studies indicate that it undergoes hydrogen bonding with coordinated TFA^- . All seems to suggest that such N(1)-H...OCOCF₃⁻ hydrogen bonding interaction, likely occurring in **8**, makes N(1) not available for nucleophilic attack and, at the same time, orients **2** in a way that C(3) might easily attack coordinated **3** leading to **4a**.

Studies addressing the exploitation of these findings in different counterion-controlled gold catalyzed selective organic transformations are currently under investigation in our laboratories.

ASSOCIATED CONTENT

General procedures, relevant NMR spectra and *in situ* catalytic experiments. This material is available free of charge via the Internet at <http://pubs.acs.org>.

AUTHOR INFORMATION

Corresponding Author

alceo.macchioni@unipg.it
marco.bandini@unibo.it

Notes

The authors declare no competing financial interests.

ACKNOWLEDGMENT

Acknowledgements are made to the Ministero dell'Istruzione dell'Università e della Ricerca (MIUR, FIRB-futuro in ricerca RBF1022UQ) and University of Bologna.

REFERENCES

- 1) (a) Krossing, I.; Raabe, I. *Angew. Chem. Int. Ed.* **2004**, *43*, 2066–2090. (b) Macchioni, A. *Chem. Rev.* **2005**, *105*, 2039–2074.
- 2) For selected examples, see: (a) Chen, E. Y.-X.; Marks, T. J. *Chem. Rev.* **2000**, *100*, 1391–1434. (b) Rifat, A.; Kociok-Köhn, G.; Steed, J. W.; Weller, A. S. *Organometallics* **2004**, *23*, 428–432. (c) Hamilton, G. L.; Kang, E. J.; Mba, M.; Toste, F. D. *Science* **2007**, *317*, 496–499. (d) Lacour, J.; Moraleda, D. *Chem. Commun.* **2009**, 7073–7089. (e) Liao, S.; List, B. *Angew. Chem. Int. Ed.* **2010**, *49*, 628–631.
- 3) Bellachioma, G.; Cardaci, G.; Macchioni, A.; Reichenbach, G.; Terenzi, S. *Organometallics* **1996**, *15*, 4349–4351.
- 4) (a) Macchioni, A. *Eur. J. Inorg. Chem.* **2003**, 195–205. (b) Pregosin, P. S.; Kumar, P. G. A.; Fernández, I. *Chem. Rev.* **2005**, *105*, 2977–2998.
- 5) (a) Macchioni, A.; Ciancaleoni, G.; Zuccaccia, C.; Zuccaccia, D. *Chem. Soc. Rev.* **2008**, *37*, 479–489. (b) Zuccaccia, D.; Macchioni, A. *Organometallics* **2005**, *24*, 3476–3486.
- 6) (a) Macchioni, A.; Bellachioma, G.; Cardaci, G.; Travaglia, M.; Zuccaccia, C.; Milani, B.; Corso, G.; Zangrando, E.; Mestroni, G.; Carfagna, C.; Formica, M. *Organometallics* **1999**, *18*, 3061–3069. (b) Zuccaccia, C.; Stahl, N. G.; Macchioni, A.; Chen, M.-C.; Roberts, J. A.; Marks, T. J. *J. Am. Chem. Soc.* **2004**, *126*, 1448–1464. (c) Rocchigiani, L.; Ciancaleoni, G.; Zuccaccia, C.; Macchioni, A. *Angew. Chem. Int. Ed.* **2011**, *50*, 11752–11755.
- 7) Appelhans, L. N.; Zuccaccia, D.; Kovacevic, A.; Chianese, A. R.; Miecznikowski, J. R.; Macchioni, A.; Clot, E.; Eisenstein, O.; Crabtree, R. H. *J. Am. Chem. Soc.* **2005**, *127*, 16299–16311.
- 8) Rocchigiani, L.; Ciancaleoni, G.; Zuccaccia, C.; Macchioni, A. *J. Am. Chem. Soc.* **2014**, *136*, 112–115.
- 9) (a) Hashmi, A. S. K.; Hutchings, G. J. *Angew. Chem., Int. Ed.* **2006**, *45*, 7896–7936. (b) Fürstner, A.; Davies, P. W. *Angew. Chem., Int. Ed.* **2007**, *46*, 3410–3449. (c) Hashmi, A. S. K. *Chem. Rev.* **2007**, *107*, 3180–3211. (d) Jiménez-Núñez, E.; Echavarren, A. M. *Chem. Rev.* **2008**, *108*, 3326–3350. (e) Arcadi, A. *Chem. Rev.* **2008**, *108*, 3266–3325. (f) Skouta, R.; Li, C.-J. *Tetrahedron* **2008**, *64*, 4917–4938. (g) Li, Z. G.; Brouwer, C.; He, C. *Chem. Rev.* **2008**, *108*, 3239–3265. (h) Fürstner, A. *Chem. Soc. Rev.* **2009**, *38*, 3208–3221. (i) Shapiro, N.; Toste, F. D. *Synlett* **2010**, 675–691. (j) De Haro, T.; Nevado, C. *Synthesis* **2011**, 2530–2539. (k) Bandini, M. *Chem. Soc. Rev.* **2011**, *40*, 1358–1367. (l) Boorman, T. C.; Larrosa, I. *Chem. Soc. Rev.* **2011**, *40*, 1910–1925. (m) Corma, A.; Leyva-Pérez, A.; Sabater, M. J. *Chem. Rev.* **2011**, *111*, 1657–1712. (n) Leyva-Pérez, A.; Corma, A. *Angew. Chem. Int. Ed.* **2012**, *51*, 614–635. (o) Hashmi, A. S. K.; Rudolph, M. *Chem. Soc. Rev.* **2012**, *41*, 2448–2462. (p) Brooner, R. E. M.; Widenhofer, R. A. *Angew. Chem. Int. Ed.* **2013**, *52*, 11714–11724.
- 10) (a) Kovács, G.; Ujaque, G.; Lledós, A. *J. Am. Chem. Soc.* **2008**, *130*, 853–864. (b) Zhdanko, A.; Ströbele, M.; Maier, M. E. *Chem. Eur. J.* **2012**, *18*, 14732–14744. (c) Zhdanko, A.; Maier, M. E. *ACS Catal.* **2014**, *4*, 2770–2775. (d) Jia, M.; Bandini, M. *ACS Catal.* **2015**, *5*, 1638–1652, and references therein.
- 11) (a) Zuccaccia, D.; Belpassi, L.; Tarantelli, F.; Macchioni, A. *J. Am. Chem. Soc.* **2009**, *131*, 3170–3171. (b) Zuccaccia, D.; Belpassi, L.; Rocchigiani, L.; Tarantelli, F.; Macchioni, A. *Inorg. Chem.* **2010**, *49*, 3080–3082. (c) Biasiolo, L.; Trinchillo, M.; Belanzoni, P.; Belpassi, L.; Busico, V.; Ciancaleoni, G.; D'Amora, A.; Macchioni, A.; Tarantelli, F.; Zuccaccia, D. *Chem. Eur. J.* **2014**, *20*, 14594–14598. (d) Ciancaleoni, G.; Belpassi, L.; Zuccaccia, D.; Tarantelli, F.; Belanzoni, P. *ACS Catal.* **2015**, *5*, 803–814.
- 12) Zhuo, C.-X.; Zhang, W.; You, S.-L. *Angew. Chem. Int. Ed.* **2012**, *51*, 12662–12686.
- 13) Jia, M.; Cera, G.; Perrotta, D.; Monari, M.; Bandini, M. *Chem. Eur. J.* **2014**, *20*, 9875–9878.
- 14) (a) Bandini, M.; Bottoni, A.; Chiarucci, M.; Cera, G.; Miscione, G. *J. Am. Chem. Soc.* **2012**, *134*, 20690–20700. (b) Romano, C.; Jia, M.; Monari, M.; Manoni, E.; Bandini, M. *Angew. Chem. Int. Ed.* **2014**, *53*, 13854–13857. (c) Jia, M.; Monari, M.; Yang, Q.-Q.; Bandini, M. *Chem. Commun.* **2015**, *51*, 2320–2323.
- 15) Kimber, M. C. *Org. Lett.* **2010**, *12*, 1128–1131.
- 16) Neuhaus, D.; Williamson, M. P. *The Nuclear Overhauser Effect in Structural and Conformational Analysis*, 2nd ed., Wiley-VCH, Weinheim, **2000**.
- 17) Despite anhydrous methylene chloride was used, water traces contained in the starting materials were enough to open collateral reaction pathways.
- 18) (a) Zhang, G.; Peng, Y.; Cui, L.; Zhang, L. *Angew. Chem., Int. Ed.* **2009**, *48*, 3112–3115. (b) Nieto Faza, O.; Silva Lopez, C. *J. Org. Chem.* **2013**, *78*, 4929–4939.
- 19) Montserrat, S.; Faustino, H.; Lledós, A.; Mascareñas, J. L.; López, F.; Ujaque, G. *Chem. Eur. J.* **2013**, *19*, 15248–15260.
- 20) The dynamic nature of these complexes notably hampers the complete NMR characterization. Anyway, the possibility that [Au-allene][TFA] complexes exist, in this case, as neutral complexes featuring TFA group in position 1 and Au σ -bonded to C(2) (see below) has been ruled out since the NOE contact of TFA with the CH₂(1) is too weak if compared with that of the phosphite ligand, thus suggesting the presence of an ion pair (Supporting Information).

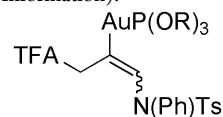

21) Suárez-Pantiga, S.; Hernández-Díaz, C.; Piedrafita, M.; Rubio, E.; González, J. M. *Adv. Synth. Catal.* **2012**, *354*, 1651–1657.

22) ³¹P chemical shift values are slightly different from those observed in the reaction between 1TFA and **3**, likely due to the different experimental conditions such as temperature, **1** and **3** concentration and presence of **2** in the mixture.

TOC image:

