



ALMA MATER STUDIORUM
UNIVERSITÀ DI BOLOGNA

ARCHIVIO ISTITUZIONALE DELLA RICERCA

Alma Mater Studiorum Università di Bologna Archivio istituzionale della ricerca

Imaging agents based on lanthanide doped nanoparticles

This is the final peer-reviewed author's accepted manuscript (postprint) of the following publication:

Published Version:

Imaging agents based on lanthanide doped nanoparticles / Prodi, L.; Rampazzo, E.; Rastrelli, F.; Speghini, A.; Zaccheroni, N.. - In: CHEMICAL SOCIETY REVIEWS. - ISSN 0306-0012. - STAMPA. - 44:14(2015), pp. 4922-4952. [10.1039/c4cs00394b]

Availability:

This version is available at: <https://hdl.handle.net/11585/518716> since: 2020-02-25

Published:

DOI: <http://doi.org/10.1039/c4cs00394b>

Terms of use:

Some rights reserved. The terms and conditions for the reuse of this version of the manuscript are specified in the publishing policy. For all terms of use and more information see the publisher's website.

This item was downloaded from IRIS Università di Bologna (<https://cris.unibo.it/>).
When citing, please refer to the published version.

(Article begins on next page)

This is the final peer-reviewed accepted manuscript of:

L. Prodi, E. Rampazzo, F. Rastrelli, A. Speghini and N. Zaccheroni "Imaging agents based on lanthanide doped nanoparticles" **2015**, *Chem. Soc. Rev.*, 44, 4922-4952

SN - 0306-0012

DO - 10.1039/C4CS00394B

M3 - 10.1039/C4CS00394B

UR - <http://dx.doi.org/10.1039/C4CS00394B>

The final published version is available online at:

<https://pubs.rsc.org/en/content/articlelanding/2015/CS/C4CS00394B>

Rights / License:

The terms and conditions for the reuse of this version of the manuscript are specified in the publishing policy. For all terms of use and more information see the publisher's website.

This item was downloaded from IRIS Università di Bologna (<https://cris.unibo.it/>)

When citing, please refer to the published version.

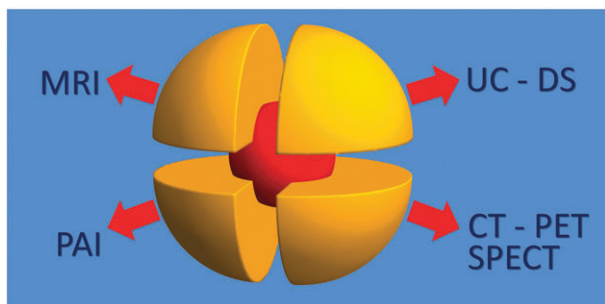

Imaging agents based on lanthanide doped nanoparticles

Q1 Q2

L. Prodi,* E. Rampazzo, F. Rastrelli, A. Speghini and N. Zaccheroni

This review summarizes the recent progress of single and multimodal imaging agents based on lanthanide doped nanoparticles.

Please check this proof carefully. **Our staff will not read it in detail after you have returned it.**

Translation errors between word-processor files and typesetting systems can occur so the whole proof needs to be read. Please pay particular attention to: tabulated material; equations; numerical data; figures and graphics; and references. If you have not already indicated the corresponding author(s) please mark their name(s) with an asterisk. Please e-mail a list of corrections or the PDF with electronic notes attached – do not change the text within the PDF file or send a revised manuscript. Corrections at this stage should be minor and not involve extensive changes. All corrections must be sent at the same time.

Please bear in mind that minor layout improvements, e.g. in line breaking, table widths and graphic placement, are routinely applied to the final version.

Please note that, in the typefaces we use, an italic vee looks like this: ν , and a Greek nu looks like this: ν .

We will publish articles on the web as soon as possible after receiving your corrections; **no late corrections will be made.**

Please return your **final** corrections, where possible within **48 hours** of receipt, by e-mail to: chemsocrev@rsc.org

Queries for the attention of the authors

Journal: **Chem Soc Rev**

Paper: **c4cs00394b**

Title: **Imaging agents based on lanthanide doped nanoparticles**

Editor's queries are marked on your proof like this **Q1**, **Q2**, etc. and for your convenience line numbers are indicated like this 5, 10, 15, ...

Please ensure that all queries are answered when returning your proof corrections so that publication of your article is not delayed.

Query reference	Query	Remarks
Q1	For your information: You can cite this article before you receive notification of the page numbers by using the following format: (authors), Chem. Soc. Rev., (year), DOI: 10.1039/c4cs00394b.	
Q2	Please carefully check the spelling of all author names. This is important for the correct indexing and future citation of your article. No late corrections can be made.	
Q3	Do you wish to add an e-mail address for the corresponding author?	
Q4	"Accumulator" and "background" appear to be spelled incorrectly in Scheme 1. Please could you supply a corrected version (preferably as a TIF file at 600 dots per inch) with your proof corrections.	
Q5	The sentence beginning "Under a 980 nm excitation. . ." has been altered for clarity, please check that the meaning is correct.	
Q6	"Shi" and "Bu" are not cited as authors of ref. 78. Please indicate any changes that are required here.	
Q7	Although there is a citation to Fig. 33 in the text, Fig. 33 does not appear to have been provided. Do you wish to provide this or would you like this citation to be removed?	
Q8	A citation to Fig. 18 has been added here, please check that the placement of this citation is suitable. If the location is not suitable, please indicate where in the text the citation should be inserted.	
Q9	Ref. 22: Please provide the page (or article) number(s).	
Q10	Ref. 49: Can this reference be updated? Please supply details to allow readers to access the reference (for references where page numbers are not yet known, please supply the DOI).	
Q11	Ref. 159: Please provide the initial(s) for the 4th author.	

Imaging agents based on lanthanide doped nanoparticles

Q1 Q2

10

L. Prodi,^{*a} E. Rampazzo,^a F. Rastrelli,^b A. Speghini^c and N. Zaccheroni^a

Nanotechnology has recently allowed us to design and prepare nanoplateforms with the potential to face currently unresolved problems. Among these platforms, nanoparticles in particular are versatile objects that find applications in many different areas. In the vast ensemble of materials that have been explored to obtain nanoparticles with improved performances, we here focus our attention on lanthanide-based nanocrystals. These recently developed species are extremely interesting and well known particularly for their ability to emit anti-Stokes shifted light (upconversion) with relatively high brightness. Many advantageous characteristics of such materials are emerging, and their use as multimodal imaging agents is rapidly growing. We here survey some recent examples on this subject, mainly focusing on systems having NIR-to-NIR emission properties for *in vivo* applications.

While perceived as a frontier research field, nanotechnology is also an already well-established and fast growing discipline that

finds widespread applications with health, environmental and social outcomes. It would be therefore redundant in this context to describe all the advantages of nanotechnology; yet, we would like to mention the key point that, in our opinion, explains the reason why this successful discipline has become now so fundamental: merging. Nanotechnology merges materials, properties and goals to obtain multimaterial-multifunctional-multitarget objects – an approach already paved by supramolecular chemistry – but pushed even further.

^a Dipartimento di Chimica “G. Ciamician” and INSTM, UdR Bologna, Università di Bologna, Via Selmi 2, 40126 Bologna, Italy

^b Dipartimento di Scienze Chimiche, Università degli Studi di Padova, Via Marzolo 1, 35131 Padova, Italy

^c Dipartimento di Biotecnologie, Università degli Studi di Verona Ca' Vignale 1, Strada Le Grazie 15, 37134 Verona, Italy



L. Prodi

Luca Prodi received his PhD in 1992. In 2006 he became a full Professor of General and Inorganic Chemistry at the University of Bologna, and in May 2015 he was elected Head of the “Giacomo Ciamician” Department of Chemistry. His research activity is focussed on the synthesis and characterization of luminescent labels and sensors, using the supramolecular approach for the analyte recognition and the signal transduction steps. In this context,

he is also actively working on the synthesis and characterization of metal and silica nanoparticles, in order to obtain more efficient sensors and labels through signal amplification, mainly for bio-medical applications. He is an inventor of 4 international patents and a co-founder of two spin-off companies.



E. Rampazzo

Enrico Rampazzo was born in Verona in 1973. He completed his PhD at the University of Padua under the supervision of Umberto Tonellato and Fabrizio Mancin. He was a FIRB young researcher and a postdoctoral fellow with Luca Prodi and Marco Montalti at the Photochemical Nanosciences Laboratory of the University of Bologna (Italy). He is now an assistant professor in the same group. His research focuses on the design and synthesis of luminescent and (electro)luminescent systems based on dye doped silica nanoparticles for the development of labels and sensors.

10

15

20

25

30

35

40

45

50

55

15

20

25

30

35

40

45

50

55

This merging ultimately leads to nanoplatforms that may become very powerful tools to face current unresolved problems. Environment and energy are for sure two of the greatest issues that the modern world must address nowadays. Indeed, much effort has been directed towards the healing of the human body through medicine, in the form of prevention, diagnosis, and therapy. This last point is so important that the word *theranostics*¹ has been introduced to indicate a treatment strategy that combines therapeutics with diagnostics.² Clearly, in the design of platforms to be used *in vivo*, there exist many and urgent constrains such as toxicity,³ stability, environmental compatibility, time of clearance, and output signal reliability and intensity.⁴

Many are the possible techniques in modern medical imaging that can be exploited to generate a signal to be tracked. Non-invasive imaging methods using exogenous chemical



F. Rastrelli

Federico Rastrelli was born in 1973. He completed his PhD under the supervision of Alessandro Bagno and Gianfranco Scorrano at the University of Padova, where he currently holds an assistant professor position. In the group of Alessandro Bagno he has been working on experimental NMR and quantum chemical calculations in small diamagnetic and paramagnetic molecules. His present research interests include the design of NMR methodologies

for the investigation of nanosystems and the study of transport phenomena in complex matrices.

contrast agents (CA), in fact, are a booming frontier research area with an expected breakthrough in diagnostics and in all medical activities that can be imaging-guided such as surgery, drug delivery and therapy monitoring.⁵ The main challenges for *in vivo* imaging, to date, include the development of new contrast agents with increased sensitivity and specificity.⁶ The most promising approach that has emerged from the research efforts worldwide points distinctly toward nanostructured and nanosized probes⁷⁻¹⁰ that are compatible with most imaging modalities and that can be optimized for targeting,¹¹ multimodality and activation. The various imaging techniques differ significantly in fundamental features (Table 1) such as the resolution, penetration depth, time of analysis and cost – with pros and cons depending on the investigation to be addressed. It is straightforward to understand how the combination of two or more of them – bringing to multimodality – can help overcome the single constraints.¹² Even if this approach is already followed in medical applications, pushing forward multimodal imaging still remains one of the main goals of *in vivo* imaging research. Magnetic resonance imaging¹³ (MRI), computed X-ray tomography¹⁴ (CT), nuclear medical imaging¹⁵ (NM) such as positron emission tomography (PET) and single-photon emission computed tomography (SPECT), ultrasound imaging¹⁶ (US) are the modalities that already find a large clinical application. It is worth pointing out that MRI and PET instrumentation suffer from high costs, something which plays a crucial role in modern healthcare systems. In addition MRI has a quite low sensitivity (together with CT) and very long acquisition times in comparison with other tomographic techniques (around 30 minutes versus seconds-minutes). Conversely, MRI can offer a non-limited penetration depth, a high resolution and a high soft-tissue contrast.

All these advantages, along with the virtual absence of health risks, make this technique one of the most commonly



A. Speghini

Adolfo Speghini, born in 1963, received his MD (1988) in chemistry and PhD (1992) in chemistry from the University of Padova (Italy). After post-doctoral studies at the University of Verona, he became a Researcher (1997) and an Associate Professor of Inorganic Chemistry (2006) at the Department of Biotechnology, the University of Verona. He was a visiting scientist at the Universidad Autonoma de Madrid (Spain), Universidad Autonoma Metropolitana (Mexico),

Humboldt-Universität zu Berlin (Germany) and a visiting professor at the Institut National de la Recherche Scientifique (Canada). His research interests are focused on the development of nanomaterials and nanostructures in colloidal forms for biomedical diagnostic and photonic applications.



N. Zaccheroni

Nelsi Zaccheroni studied and obtained her PhD in Chemical Sciences (1997) from the University of Bologna (Italy), where she is now an Associate Professor in Chemistry since September 2014. She spent one year (1997–1998) as a postdoctoral fellow within a TMR-CEE project at the University College of Dublin (Ireland) where she started to approach the study of nanomaterials. Her research interests are now mainly focused

on luminescent systems for imaging and sensing, both molecular and nanostructured in particular based on silica, metal and core-shell multi-material nanoparticles.

Table 1 Main imaging techniques and their fundamental features

	Form of energy used	CA used	Sensitivity (mol L ⁻¹)	Resolution ^a (mm)	Depth (mm)	Time of analysis min-h	Addition disadvantages	Additional advantages	Clinical translation	Costs
MRI	Radio waves	Gadolinium chelates containing NPs Iron oxide NPs	10 ⁻³ -10 ⁻⁵	0.01-0.1 (small animal) 0.5-1.5 (clinical)	No limitations			Very high soft tissue discrimination Functional imaging without imaging probes	Yes	High
CT	X-rays	Iodinated molecules X-ray absorbing NPs	10 ⁻¹	0.03-0.4	No limitations	s-min	Limited soft tissue discrimination Radiation concerns	imaging probes	Yes	Medium/low
US	Sound waves (high frequency)	Microbubbles NPs	10 ⁻⁹ -10 ⁻¹¹	0.04-0.1 (small animal) 0.1-1 (clinical)	1-200	s-min	No whole body imaging Seldom target specific imaging	High sensitivity Portable	Yes	Low Medium
PET	Annihilation (γ) photons	Radionuclides	10 ⁻¹⁰ -10 ⁻¹²	1-2 (microPET) 6-10 (clinical PET)	No limitations	min	Radiation concerns Seldom target specific imaging	High sensitivity Tracer amounts of probes	Yes	High
SPECT	Gamma rays	Radionuclides	10 ⁻¹⁰ -10 ⁻¹²	0.5-2 (microSPECT) 7-15 (clinical SPECT)	No limitations	min		High sensitivity and high contrast High sensitivity Tracer amounts of probes	Yes	Medium
PA	Vis-IR light	NIR absorbing dyes and NPs	10 ⁻⁹	0.03-0.05	1-60	min			No	Low
OI	UV-Vis and IR light	Luminescent dyes Luminescent NPs	10 ⁻⁹ -10 ⁻¹²	1-3	1-20	s-min		Multiplexing imaging, targeted and activable probes	Partial (close)	Low

^a Spatial resolution in experiments with small animals. In the case of clinical applications a resolution decrease of a factor varying from 2 to about 10 usually takes place. Adapted from ref. 12 Copyright 2014 Ivspring International Publisher.

1
5
10
15
20
25
30
35
40
45
50
551
5
10
15
20
25
30
35
40
45
50
55

used in the world together with ultrasound imaging (US, *i.e.* sonography) – that is also investigated for therapeutic treatments.¹⁷ The latter technique benefits from a high sensitivity and a short time of measurement, suffers from a limited penetration (1–200 mm). The same drawback also affects CT together with relatively poor soft tissue contrast and the concern about the X-ray radiation. Safety is an issue also in the case of NM (Nuclear Medicine) that, despite the limited spatial resolution, can ensure no limits in penetration and the highest sensitivity. In this already rich but complex scenario, significant improvements (implying very strong expectations) are estimated from two imaging modalities, optical imaging¹⁰ (OI) and photo-acoustic imaging¹⁸ (PAI), which to date have still very limited clinical translation.

These techniques are attracting funding and great research efforts^{19,20} that are estimated to bring about important achievements in a relatively short time. OI and PA share very high sensitivities and short time of measurements. OI can suffer from a relatively limited resolution in comparison with other imaging modalities but, on the other side, it has a quite unique versatility, such as the possibility to exploit light not only for diagnostic purposes but also for therapeutic treatments (photodynamic²¹ and photothermal therapy, PDT and PTT respectively^{22–26}). Moreover, properly designed probes can allow multiplexed imaging^{27,28} a very valuable high-throughput possibility that, monitoring many parameters/analytes at the same time, can drastically lower the required sample sizes and/or the time of analysis. The main drawback of OI and PAI, however, is their low investigation depth (< 20 mm for OI and of 60 mm for PAI) in the case of *in vivo* applications. Due to the absorption and scattering of tissues (especially between 400 and 700 nm), in fact, the propagation of the excitation and, for OI, emission radiation is an issue. This may be at least partially overcome in the future thanks to the anticipated great advances of real/time endoscopic²⁹ and laparoscopic imaging introduced by the new generations of more and more miniaturized instruments. In addition, OI is finding growing interest from surgeons since it can help guiding their procedures by visualizing, for example, a tumour mass to be resected with great accuracy.

A necessary step to improve the penetration depth is anyway to optimize the probes to exploit the *biological optical transparency window* (650–1800 nm), a region that takes into account absorption and scattering caused by the species and structures of the different skin layers.³⁰ This region can be divided in the so-called NIR-1 (650–950 nm, where the tissue scatter and auto-fluorescence are still quite high), NIR-2 (1000–1350 nm, where the water absorption increases) and NIR-3 (1500–1800 nm).²⁰ The reason for the two gaps that separate the three NIR (near infrared) ranges can be found in two absorption peaks of water, the first one centred at around 980 nm and the second much higher one at about 1450 nm (Fig. 1). The excitation or emission light falling in these two sections is therefore partially absorbed and thus suffering of limited penetration. It is also worth pointing out another detrimental consequence: the excitation *via* laser light at 980 nm, very common in the structures involving Yb³⁺ ions, causes the transformation of

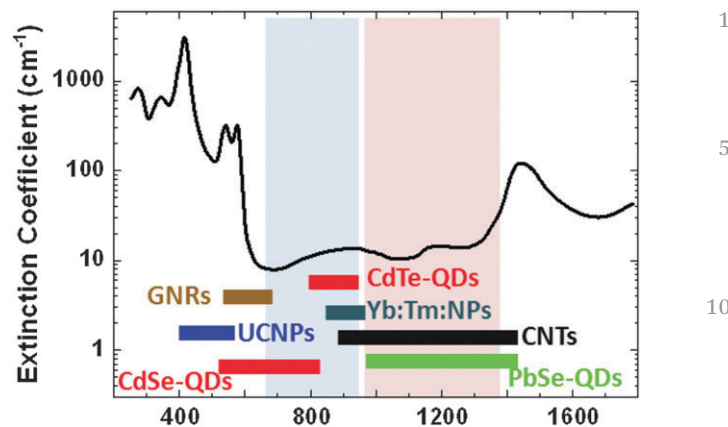

Fig. 1 Attenuation coefficient of human blood (oxygenated) in the 300–1700 nm spectral range. NIR-1 (blue color) and NIR-2 (pink color) biological windows are indicated. The emission spectral ranges of luminescent NPs classes used for fluorescent bioimaging are included (GNRs, gold nanorods; UCNPs, upconverting NPs; QDs, quantum dots; CNTs, carbon nanotubes). Adapted from ref. 31 Copyright 2014 Wiley-VCH Verlag GmbH & Co. KGaA, Weinheim.

the absorbed energy into a local heating of biological samples, a potentially very critical problem. All this has to be carefully taken into account in designing suitable systems for applications in biomedical imaging. Such systems must combine NIR absorption and emission of light, to ensure a significant increase in penetration^{20,23} with other advantages such as low damage of tissues and cells, which is always a concern with long-term UV excitation, and reduced light scattering and auto-fluorescence.

A great number of possible variables govern the properties of lanthanide doped NPs: this complexity makes such materials very challenging but extremely versatile at the same time. Several examples of NPs have been developed, which are chemically and photochemically stable, with sharp emission bands (including intense anti-Stokes ones), NIR excitation–emission, long lifetimes and low toxicity. Their properties, however, are not only confined to luminescence – in many permutations they are also suitable candidates for imaging techniques such as MRI (see Section 4), CT and also NM (see Section 5). In the last few years the area of lanthanide doped NPs has therefore boost up with the application of single and multimodal systems to imaging³² and therapy,^{33,34} but much effort is still needed to translate them into the clinic.

The multifaceted interest in these materials is certainly testified by the impressive number of publications and reviews that are appearing in the literature daily describing the production of lanthanide-doped nanocrystals^{20,33,35–38} and their possible applications.^{19,20,33,39–42} Several factors such as the morphology, crystalline phase, size, and components of these nanomaterials are crucial parameters acting on their electrical, photophysical, magnetic, and colloidal stability properties.^{43,44} Most of the synthetic routes – whose implementations are unfortunately still often linked to a trial-and-error approach – focus on achieving a rational control over these elements.

In this constantly evolving scenario, we have decided to give the reader an overview of the state of the art, not even trying to

1 be exhaustive but rather focusing on lanthanide-doped nano-
crystals both absorbing and emitting in the NIR (1 or 2) region.
We have chosen this restricted subject as the most promising
5 and innovative in the development of theranostic nanomaterials
for the future of mankind. In this context, NIR contrast
agents, specifically targeted and eventually activated^{40,45} for
drug delivery, represent some of the most relevant results to be
achieved in the next future. In this review article we have
10 classified the results found in the literature depending on the
imaging modality for which the lanthanide doped nano-
particles were designed. For each of them we begin with a brief
introduction on the principles at the basis of the method. The
theoretical outline introducing the lanthanide based nanocrystals
15 as MRI contrast agents (Section 4) has been expanded in
proportion to the complexity of the subject: we have tried,
however, to keep the dissertation within reach of a wide
readership.

Finally, since lanthanide doped nanocrystals are appealing
materials that will take to unpredictable and bright advance-
20 ments in many disciplines of high social impact, we have tried
to make the new achievements as accessible as possible also to
interested researchers working in different fields.

25 2. Lanthanide-doped nanocrystals for optical imaging

Among the variety of possible luminescent materials only a very
limited group presents NIR adsorption and emission proper-
30 ties. Materials based on lanthanide ions (Ln^{3+} , from lanthanum
to lutetium) are included in this set. Lanthanide ions are
characterized by the progressive filling of the highly shielded
4f orbitals, originating many states with energies determined
by the combinations of three contributions: the inter-electronic
35 repulsion, the spin-orbit coupling and the ligand field. The
lower energy excited states in the lanthanide ions are always
determined by the rearrangement of the electrons in the f
orbitals that give rise to very narrow f-f absorption bands (with
semi-width even lower than 1 nm) and with very low absorption
40 coefficients (rarely above the unity) due to their forbidden
character. These transitions give rise to the emission of these
ions that are again very narrow and, due to their low prob-
ability, with very long radiative lifetimes – often in the range of
milliseconds. Frequently, the nonradiative deactivation
45 through the vibronic coupling with species in close proximity
or *via* excited states with different configurations is very effi-
cient. Therefore, to obtain highly luminescent materials based
on Ln^{3+} ions, there are two problems to be overcome: (i) the
inefficient process of their direct excitation and (ii) an efficient
50 nonradiative deactivation. The research of possible solutions
constitutes a very lively research field since several decades and
many different ways have been proposed to obtain lumines-
cence from lanthanide ions through indirect sensitization
processes from light-absorbing systems. Lanthanide coordina-
55 tion can allow efficient energy transfer from light harvesting
organic-antenna chromophores,⁴⁶ or by organic aromatic

ligands that are directly bound to the lanthanide centres or,
again, by light harvesting metal-organic antenna chromo-
phores in heteronuclear metallo-organic complexes.⁴⁷ There
are also other less traditional and very intriguing possibilities
5 such as doping lanthanide inorganic matrixes with other metal
ions to obtain luminescent glasses or more organized nano-
sized materials such as lanthanide doped nanoparticles.

Lanthanide doped nanoparticles, which are the topic of this
review, are gaining more and more attention in the last few
decades merging the advantages of nanomaterials with unique
10 optical properties.³³ They are formed by a suitable dielectric
host lattice where trivalent lanthanide ions are dispersed at low
concentration. Their emission properties are influenced by the
nature, the composition and the structure of the nanoparticle,
but they are not directly dependent on their size or shape as it is
15 typical of many other nanostructured systems such as quantum
dots (QDs).

These luminescent properties differ significantly by other
luminescent nanoparticles for the possibility of giving rise to
efficient anti-Stokes emission processes. The classic down-
20 shifting emission (DS), which is advantageously used also with
lanthanide-doped nanocrystals, consists in the conversion of
the higher energy excitation photons into lower energy ones
following the Stokes law. In contrast, in up-conversion emis-
sion (UP) processes the sequential absorption of two or more
25 photons and energy transfer processes allow the emission of
higher energy photons.⁴⁸ Interestingly, as we will see, some
researchers have also conceived lanthanide-doped nanocrystals
in which both modalities can be used.

Whichever the mechanism (DS or UC), since the excited
30 state responsible for the emission is for almost all these
systems centred on the lanthanide ion, they share common
features. In particular, together with the already mentioned
sharp emissions and rather long excited state lifetimes, the
luminescence intensity depends on the nature and concen-
35 tration of the components, on the nature of the matrix and on
the synthetic conditions.

The nano-range size is of central importance for biomedical
applications, since the dimension entails internalization and
release in cells, organs and biological hosts. Other fundamental
40 aspects are solubility,¹⁹ biocompatibility⁴⁹ and low-toxicity⁵⁰
that depend very much upon the nature of the surface of
lanthanide-doped nanoparticles, which can be conveniently func-
tionalized,³⁹ as already mentioned, to allow also bioconjugation.

2.1 UCNPs: anti-Stokes-emitting NPs

The most intriguing emission property of lanthanide doped
nanophosphors is the UC luminescence. Ion-doped upconvert-
5 ing bulk materials are known from more than 50 years,⁵¹ and
the understanding of the role of the different mechanisms⁵²
involved in this phenomenon^{52,53} was really improved by the
availability in the following years of powerful NIR laser exciting
sources. These upconverting bulk materials have been initially
mainly used in the area of optical devices (such as in solid state
50 lasers)⁵⁴ and only the advent of upconverting nanoparticles
(UCNPs) has opened up the way to bio-medical applications,^{55,56}

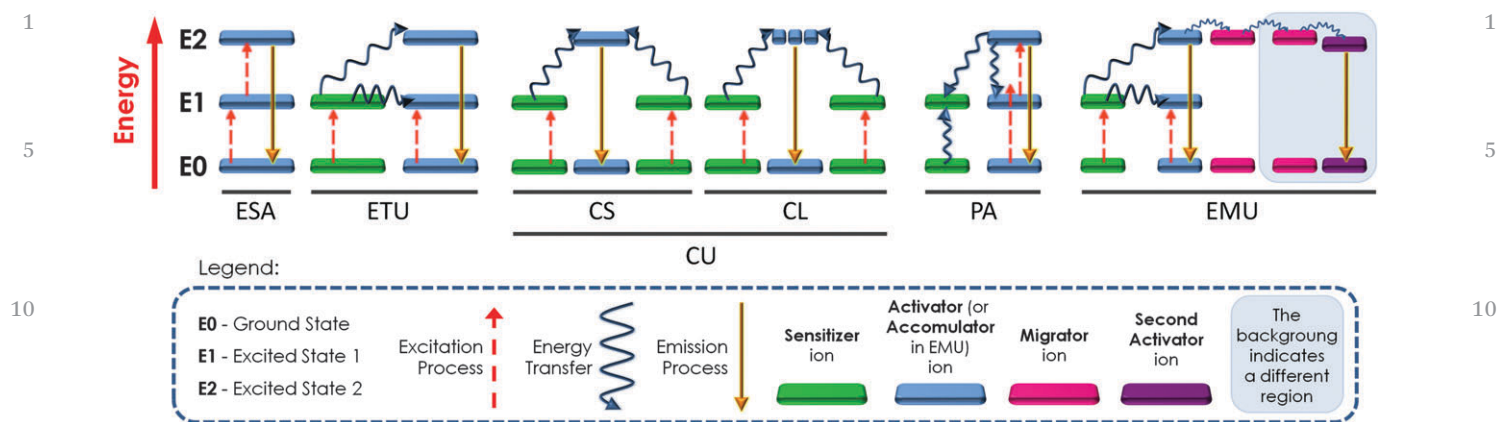

Scheme 1 Energy level schematization of the main reported lanthanide ion anti-Stokes mechanisms (see the text for the acronyms).

also thanks to the recently improved emission efficiency that has always been an issue in upconversion materials. This can be attributed to the careful design of materials with customized and optimized optical properties.^{40,41,57} The possible strategies are many and the characteristics of UCNPs can be tuned *via* the proper choice of the right host-dopant combination, *via* the engineering of the nanostructure (for example with an appropriate core-shell design)⁵⁸ or *via* the addition of suitable further species able to exchange energy with the other constituents. We can say that, generally, all the strategies involve the combination of three main components: a host matrix, a sensitizer and an activator (the emitting Ln^{3+} ion).

Host materials (matrix) play a fundamental role in the UC being not simply scaffolds, they have to present necessary features such as: (i) the right lattice dimensions to tightly hold the Ln^{3+} guest ions, (ii) a low lattice phonon energy to minimize nonradiative processes, (iii) a negligible absorption in the spectral working region and (iv) a high chemical and photo-physical stability. Alkaline earth fluorides are, to date, the best performing ones and therefore the most studied also in the area of biomedical imaging, although oxide based ones (*e.g.* sesquioxides or oxosulfides) can be a valid alternative.⁵⁹⁻⁶¹

The Ln^{3+} guest ions providing the UC emission are called *activators* and can present bands in a large spectral range under very different excitation power densities (ions with ladder-like disposition of the electronic states require low power, the others much higher one). To avoid cross-relaxation energy losses, it is necessary to use very low doping degrees of activators (<2%) and this is detrimental for the brightness: to overcome this problem the most common approach is to prepare doubly-doped nanoparticles that present a *sensitizer* with a much higher doping concentration (around 20%) together with the activator. Its function is to absorb energy in the NIR region (and therefore a large cross-section is needed) and to efficiently transfer it to the emitting ions. Yb^{3+} is the candidate that better matches these requirements and by far the most common sensitizer.

UC luminescence takes place *via* a number of different mechanisms, all favoured by the long lifetime of f-f transitions that allows energy transfer among lanthanide ions and increases

the probability of sequential excitation of the same ion. These mechanisms could be distinguished in five different processes (Scheme 1): (i) excited-state absorption (ESA), (ii) energy-transfer upconversion (ETU), (iii) cooperative upconversion (CU) (where one can discriminate cooperative sensitization upconversion (CS) and cooperative luminescence upconversion⁶² (CL)), (iv) photon avalanche (PA) and (v) energy migration-mediated upconversion (EMU).⁶³

We would like to present here very shortly the differences of these various mechanisms trying to recall only the essential information that could be of help for the reader, without any ambition to be exhaustive on the topic that has already been brilliantly treated in detail by many researchers.^{33,52,64-66}

(i) ESA takes place in ions presenting a ladder-like disposition of the electronic states (Er^{3+} , Ho^{3+} , Tm^{3+} and Nd^{3+}) with almost identical energy separation among successive ones. This, together with their long lifetime, allows the sequential absorption of two photons by the same activator ion that then emits from the second energy level.

(ii) ETU needs a neighbouring sensitizer and an activator to occur and it is therefore dependent on dopant concentrations. The sensitizer absorbs photons and *via* sequential energy transfer processes (one of them occurring between two ions both in an excited state⁵²) takes the activator to its second emitting level generating UC emission. This process is the one at the bases of the high efficiency of the Yb^{3+} doped UCNPs that are to date the most exploited and common ones.

(iii) CU can be distinguished in cooperative sensitization or cooperative luminescence upconversion. CS involves three ions, generally two sensitizers and one activator, and the simultaneous energy transfer of the photons absorbed by the sensitizers to the emitting ion populates its upper level that deactivates *via* UC emission. In the CL, in contrast, the simultaneous deactivation of two excited ions provides an emission with twice the energy of the single excited states. CL presents a much lower efficiency than the other mechanisms and therefore it is not usually exploited in the engineering of UCNPs.

(iv) PA⁵³ requires laser-pump radiation above a critical excitation power and with energy a bit higher than the one of the first excited state of the emitting ion. Under these

1 conditions an initial ESA occurs that induces both a very weak
UC emission from that activator and an efficient cross-
relaxation that takes the neighboring sensitizer to its excited
state, from where it is then able to transfer its energy back to
5 the activator. This constitutes a kind of avalanche effect in the
population of the first excited state of the activator. Long rise
time to build up (seconds) and the existence of a critical pump
threshold make easy to discriminate the occurrence of the PA
mechanism.

10 (v) EMU is the most recently proposed mechanism, it starts
with an ETU step but it involves four different types of inter-
acting centers (four lanthanide ions) with proper and defined
concentrations and arranged in a multilayered (core-shell)
structure.⁶⁷ In the first step of the EMU process the *sensitizer*
15 (I) absorbs and then transfers its energy to the higher excited
state of the *accumulator* (II), after successive energy transfers to
a first *migrator* (III) and then through the layers interface to
other *migrators* the energy is finally populating the excited state
of the *activator* (IV) ion to give the UC luminescence.

20 It is important to highlight that the UC efficiencies of the
various mechanisms are very different. In particular ETU is the
most efficient one and together with EMU (that can be seen as a
more complex ETU case) are by far the most exploited in the
design of UCNPs. In contrast, CU and above all PA require a
25 high doping concentration and therefore they are much more
common in bulk materials. Indicative orders of magnitude for
the various UC efficiencies were already reported by F. Auzel,⁵²
his studies have been the foundations of this field and
proposed this general trend: ETU > ESA > CU (CS > CL) >
30 PA. The most important point, however, is that the complexity
of the UC emission processes makes always challenging to
carefully characterize the optical properties of UCNPs. In
particular the determination of their emission quantum yield
(QY), defined as the ratio of the number of the emitted UC
35 photons to the number of absorbed photons of the excitation
radiation,³³ is not at all trivial with the direct consequence of a
difficult comparison of the performance of different particles.
This is very much due to the power dependence of the UC
intensity, which is not even univocal since UCNPs are subject to
40 different saturation levels: for the same host, activator and
doping degree, it depends on the size of the nanoparticle. The
importance to have protocols allowing a consistent evaluation
of the QY to compare the results coming from different experi-
ments, studies and applications has already been dis-
45 cussed.^{42,68} A comprehensive exposition of the methods to
calculate the QY in UCNPs is beyond the aims of this review,
we would only like to stress that the QY of the UC emission is
usually lower than 1%. This point is of fundamental impor-
tance since diagnostic imaging and theragnostic applications
50 require appropriate brightness that, in the case of UCNPs, can
even decrease with a reduction of the size. This is due not only
to the lower number of activators in a smaller volume (at the
same doping degree) but also to quenching processes entailing
the surface. In the nanoparticles, in fact, the surface to volume
55 ratio is very high exposing a relevant percentage of luminescent
centers to deactivation involving the solvent, other species in

the environment, or even surface lattice defects that can act as
1 long distance quenchers for inner activators *via* energy migra-
tion. The rational design of the external modification of UCNPs
is thus fundamental not only to control their solubility and
possible conjugation properties but also to minimize these
5 possible detrimental effects and increase the overall light
emission efficiency.⁶⁷ To the same goal a proper design of the
UCNPs can allow the control of their excitation dynamics again
of great importance in the pursuing of brighter and brighter
particles.^{65,66}

10 The controlled planning of these systems is not at all trivial
and many research groups spent significant efforts to optimize
UCNPs for optical imaging applications starting from the
doping with non Ln³⁺ ions or from the design of the matrix.
Gu, Zhao and co-workers⁶⁹ demonstrate that upon changing
15 the concentration of dopant Li⁺ in GdF₃:Yb,Er (20, 2 mol%) NPs
it is possible to modulate the energy back-transfer process
induced by the alkaline metal ions. Under a 980 nm excitation
the ratio of the green and red emission of Er³⁺ decreases with
an increase in Li⁺ doping resulting in a yellow to an enhanced
20 bright red upconversion emission suitable for NIR-to-NIR bio-
logical imaging. On the other side, also a matrix change, with a
consequent different crystallinity, can induce a 10-fold
enhancement of the UC luminescence in sub-20 nm cubic
NaLuF₄:20%Yb,1%Tm nanocrystals as described by Yang, Li
25 and co-workers.⁷⁰ This bright agents presenting both excitation
(980 nm) and emission (800 nm) in the NIR region were used
for *in vivo* imaging in animals and could reach a penetration
depth of 1.5 cm in pork tissue. This last feature is a crucial
point for *in vivo* optical imaging and, due to the transparency
30 biological window discussed in the introduction, it greatly
benefits by NIR-to-NIR luminescent probes. For this reason
most of the literature on lanthanide based UCNPs for biome-
dical applications focuses on ytterbium (sensitizer) doped NPs
that can be conveniently excited at 980 nm with common
35 continuous wave (CW) lasers of various power density. The
co-doping with one or more suitable activator ions yields NIR
luminescence ensuring also the efficient collection of the
emitted light in depth. The most common couple combinations
are Yb³⁺/Er³⁺, Yb³⁺/Tm³⁺ and Yb³⁺/Ho³⁺, with an UC emission in
40 the NIR-1 spectroscopic range. In particular, many Tm³⁺ doped
nanocrystalline fluoride hosts have been investigated, such as
NaYF₄,^{71,72} NaGdF₄,⁷³ LiYF₄⁷⁴ and CaF₂,^{75,76} due to the parti-
cularly interesting and intense emission of Tm at 800 nm.

45 The convenience of this approach has been proved compar-
ing deep-tissue imaging obtained with organic fluorophores
and with NaYF₄:0.1%Tm³⁺,20%Yb³⁺ UCNPs that showed much
higher resolution and penetration.⁷¹ However, a fundamental
requirement for a high resolution imaging is a high brightness
50 that makes mandatory the enhancement of the generally
quite low QY of these particles. One of the most elegant
and efficient strategies is the design of core-shell structures
able both to protect the lanthanide ions from nonra-
diative quenching processes and to promote energy transfer
among the different components to favour the upconversion
55 mechanisms.

1

5

10

15

20

Q5

25

30

35

40

45

50

55

Liu *et al.*⁷⁸ synthesised hexagonal NaYF₄:Yb,Er@NaYF₄ core-shell NPs with different shell thickness and investigated the correlation with UC emission intensity for colloidal dispersion in cyclohexane. They found that the green UC intensity is enhanced with increasing shell thickness until a factor of 12 with respect to the core-only NPs. Very similar species were obtained by Chen, Prasad and co-workers⁷⁹ with a systematic synthetic approach that yields size-tunable and monodispersed pure hexagonal phase NaYF₄:Tm³⁺0.5% NPs when doped with 30% of Gd ions. These nanophosphors undergo an impressive enhancement (350 fold) of the upconversion Tm luminescence (800 nm) when covered with a 2 nm shell of NaYF₄ that is able to well suppress surface quenching mechanisms. The NaYF₄:Gd³⁺30%Tm³⁺0.5%@NaYF₄ NPs showed high contrast ability when tested in *in vivo* whole-body and *ex vivo* imaging of nude mice. Many are the examples of multishell structures and we will discuss some other of them hereafter but we would also stress that they can involve different materials. For examples an outer gold shell of proper thickness on silica coated hexagonal phase NaYF₄:Yb,Er NPs presents a plasmonic absorption able to transfer excitation energy at 980 nm inducing an enhancement of all the UC emission peaks.⁸⁰

The UCNPs can also be part of more complex structures as proposed by Shi and co-workers⁷⁷ that have included NaYF₄:Yb,Tm@NaYF₄@SiO₂ nanoparticles of *circa* 33 nm of diameter in hollow mesoporous silica shell spheres (Fig. 2). They have then exploited the spectral overlap of the emission of the UCNPs with the absorption of tris(4,7-diphenyl-1,10-phenanthroline) ruthenium(II) ([Ru(dpp)₃]²⁺), also present in the cavity, to obtain selective hypoxia imaging *in vivo* under NIR excitation. Simpler systems have been proposed to detect also biologically relevant metal ions, such as Ca²⁺ or Zn²⁺ *ex vivo*⁸¹ and *in vivo* (zebrafish).⁸² In these examples the UCNPs were decorated on the surface with specific receptors suitable to take part in energy transfer processes with the nanoparticle and signal the target binding.

To make the optical imaging more and more specific many groups have investigated the possibility of introducing a target component for example folic acid (FA) to recognize tumor cells or an antibody able to interact with the antigens on gram-negative bacteria. With two different ligands – oleic acid (OA) and aminohexanoic acid (AA) – Li and co-workers⁸³ succeeded in the hydrothermal synthesis of high-quality water-soluble upconversion nanocrystals bearing appropriate functional groups using a one-step synthetic strategy. The OA/AA molar ratio allowed us to optimize water dispersibility and provided amino groups for conjugation to folic acid. Their FA surface derivatized LaF₃:20% Yb,1%Tm NPs were successfully applied in the lymphatic capillary bioimaging of small animals with a high signal-to-noise ratio (Fig. 3).

Zhang and co-workers⁸⁴ have taken advantage of the high photostability of antibody-based bacterial targeting NaYF₄:Yb,Er NPs to uniformly label and long term monitor *E. coli* in infected dendritic cells *in vitro*. The same strategy can also be used to reach a much more difficult target such as glioblastoma in brain. Commercial dyes or contrast agents generally suffer of

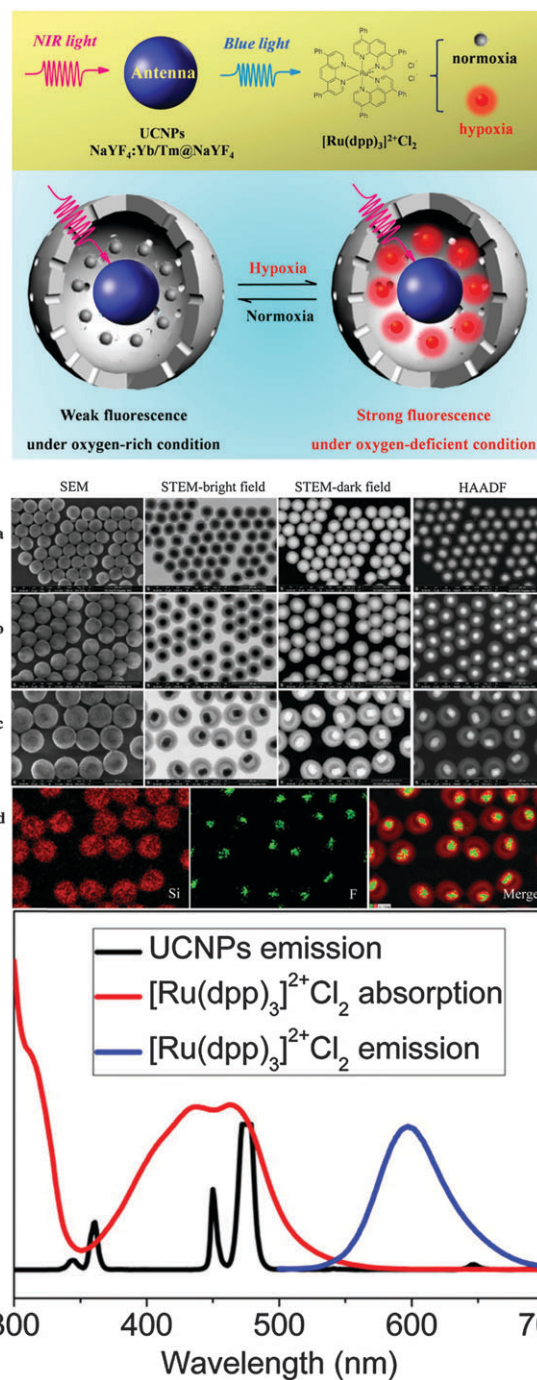

Fig. 2 Schematic illustration of the structure of nanosensors and their sensing to oxygen with a change in luminescence emission (upper). Scanning electron microscopy (SEM), bright/dark field scanning transmission electron microscopy (STEM), and high angle annular dark field (HAADF) images of UCNP@SiO₂ (a), UCNP@SiO₂@mSiO₂ (b), and UCNP@hmSiO₂ (c). (d) Corresponding elemental (F, Si) mappings of UCNP@hmSiO₂ (centre). Normalized absorption and emission spectra showing the spectral overlap of the emission of the NaYF₄:Yb/Tm NPs with the absorption of the oxygen probe [Ru(dpp)₃]²⁺Cl₂. Black line: emission spectrum of the nanoparticles under photoexcitation at 980 nm. Red and blue line: absorbance and emission spectrum of [Ru(dpp)₃]²⁺Cl₂, respectively (bottom). Adapted from ref. 77 Copyright 2014 American Chemical Society.

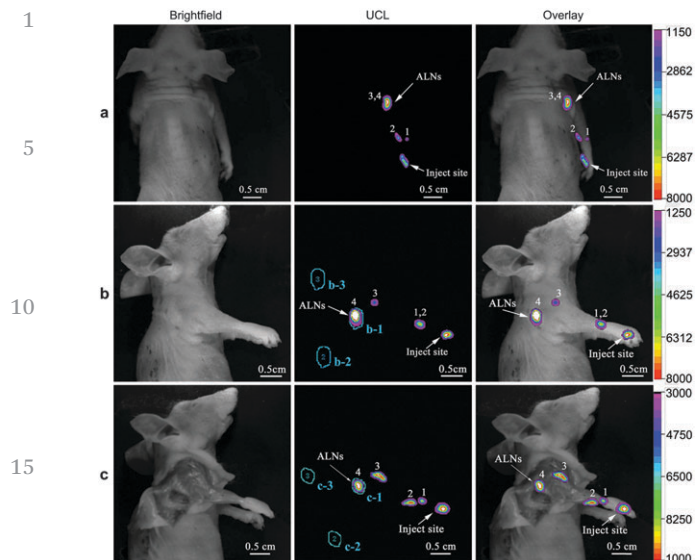

Fig. 3 *In vivo* lymphatic drainage UCL imaging at 800 nm was clearly detected at four different draining lymph basins (1, 2, 3, 4) along the right antebrachium of the nude mouse. Detection of upconversion luminescence in the different positions, prostrate (a) or lateral (b) position, after injection of 20 μL (1 mg mL^{-1}) $\text{LaF}_3\text{:Yb, Er}$ UCNPs into the paw of the nude mouse for 20 min. (c) The lymphatic drainage UCL imaging after removal of skin and fatty tissues was also measured. All images were acquired under the same instrumental conditions (power density of 120 mW cm^{-2} and temperature at 25°C on the surface of the mouse). The mean luminescence intensity ROI (blue areas): ROI 1, (specific uptake), ROI 2, (nonspecific uptake) and ROI 3 (background) were selected for the *in vivo* signal-to-noise ratio (SNR) calculation. Adapted from ref. 83 Copyright 2011 Elsevier Ltd.

poor blood–brain–barrier (BBB) permeability, non-specificity and rapid clearance and Bu, Shi and co-workers⁸⁵ have proposed a targeted, biocompatible system based on UCNPs for the diagnosis and the fluorescence positioning of glioblastoma to guide efficient tumor surgery.

They prepared $\text{NaYF}_4\text{:20\%Yb/2\%Tm/15\%Gd@NaGdF}_4$ NPs capped with amine poly(ethylene glycol)-thiol (PEG) conjugated with Angiopep-2 (ANG) that is specifically able to bind lipoprotein receptors overexpressed on both BBB and glioblastoma cells, resulting in the ANG–PEG–UCNPs nanocomposites (Fig. 4). These species have the further advantage, thanks to the presence of Gd ions, to be suitable also for MRI investigations making this system a dual-modal nanoprobe. Experiments *in vivo* did not evidence any toxicity while ANG–PEG–UCNPs showed very promising results for preoperative diagnosing and intraoperative positioning the brain tumors by MR and NIR-to-NIR UCL fluorescence imaging.

It has to be also mentioned for completeness that the administration method of the imaging agents can co-operate in the targeting process and Li and co-workers⁸⁶ have shown that the uptake of NaYF_4 nanoparticles doped with Yb^{3+} and Tm^{3+} in MVF-7 tumours *in vivo*, following intra-arterial injection, is nearly three-fold higher than that obtained by intra-venous injection for the same species. In the $\text{NaYF}_4\text{:Yb,Tm@SiO}_2$ NPs the lanthanide-doped core was synthesized using a solvothermal

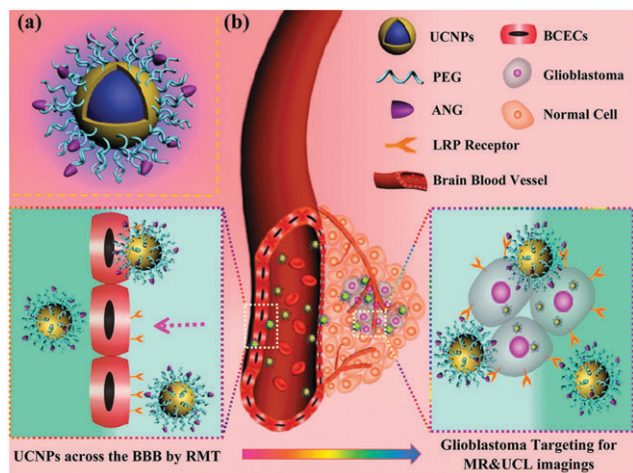

Fig. 4 (a) Design of the dual-targeting ANG–PEG–UCNPs. (b) Schematic diagram of the ANG–PEG–UCNPs as the dual-targeting system to cross the BBB and target the glioblastoma *via* LRP mediated endocytosis, enabling MR and UCL imaging of intracranial glioblastoma. Adapted from ref. 85 Copyright 2014 American Chemical Society.

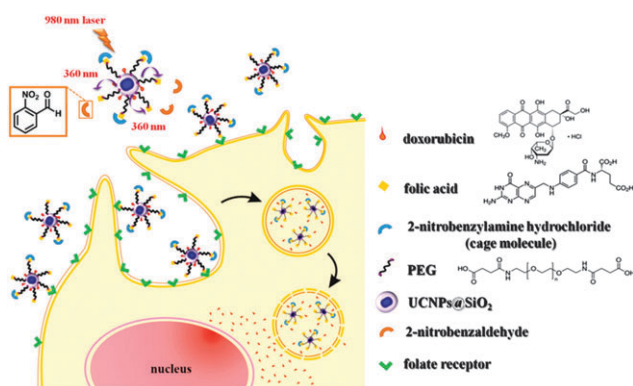

Fig. 5 PEGylated $\text{NaYF}_4\text{:Yb,Tm@SiO}_2$ NPs with therapeutic features. Adapted from ref. 87 Copyright 2013 American Chemical Society.

method (average diameter 20 nm), and during the silica coating step ethoxysilane functionalized polyethylene glycol (PEG–siloxane) was added into the microemulsion to achieve PEGylation (final hydrodynamic diameter $\sim 65 \text{ nm}$).

The implementation of these UC targeted nanolabels with therapeutic features is the last step to go from pure imaging to theranostics. Many research groups are actively investigating different possibilities and most of them take advantage again from NIR light irradiation to trigger targeting, drug release or photosensitizers.²¹

Yeh, Su and co-workers⁸⁷ have proposed PEGylated $\text{NaYF}_4\text{:Yb,Tm@SiO}_2$ NPs bearing doxorubicin (a chemotherapeutic agent) on the surface, *via* a disulfide bond that can be cleaved by lysosomal enzymes within the cells (Fig. 5).

Together with the anticancer agent, on the surface folic acid (FA) is also present with masked carboxylic groups *via* a photocleavable protecting group. In this very complex system the excitation with 980 nm light induces UC UV emission at

1 360 nm that triggers the folic acid cancerous cell targeting by
 2 activating the photocleavage reaction of FA protecting agents.
 3 The results obtained with these NIR-triggered targeting vehicles
 4 in both *in vitro* and *in vivo* imaging and in chemotherapeutic
 5 efficacy studies evidence the potential of this strategy to improve
 6 selective targeting. In this kind of systems the premature release
 7 of anticancer drugs before reaching the target can be prevented
 8 developing a stimuli-responsive controlled release approach. In
 9 particular NIR-remote-controllable nanovectors are highly desir-
 10 able for *in vivo* applications and Shi, Bu and co-workers⁷⁸ have
 11 proposed a nanoplatform based on mesoporous silica-coated
 12 NaYF₄:5%Tm,20%Yb@NaYF₄ core-shell UCNPs.

13 Subsequently the positioning of azobenzene groups (azo)
 14 into the mesopores of silica and the loading of doxorubicin
 15 yield a system that, upon absorption of NIR light (980 nm),
 16 emits UV/Vis photons that are absorbed by the azo molecules
 17 inducing a reversible *cis-trans* photoisomerization. This con-
 18 tinuous rotation-inversion movement acts as a molecular
 19 impeller that propels the release of the drug (Fig. 6).

20 The authors were able to demonstrate in *in vitro* experiments
 21 that in these NPs the drug release is only triggered by NIR
 22 exposure and the amount of the released drug is highly
 23 dependent on the duration and intensity of NIR light exposure.
 24 On the other side in slightly simpler systems where NaGdF₄:Y-
 25 b:Er (Gd : Yb : Er = 78% : 20% : 2%) are coated with bovine serum
 26 albumin (BSA) loaded with two phototherapy active dye mole-
 27 cules, the NIR light excitation induces killing of cancer cells.⁷⁹
 28 In this case 980 nm excitation causes a green light emission
 29 from UCNPs that is absorbed by the Rose bengal, a photosensi-
 30 tizer for photodynamic therapy (PDT), while the photother-
 31 mal therapy (PTT) agent IR825 dye can be directly excited at
 32 808 nm. This combined phototherapy demonstrated very good
 33 synergistic anti-tumor effects in animal experiments together
 34 with the possibility of performing dual modal optical/MR
 35 imaging. A similar UCNP-based theranostic nanosystem has
 36 been proposed by Liu and co-workers,⁸⁸ in this case a layer-by-
 37 layer self-assembly strategy is employed to load multiple strata
 38 of Chlorin e6 (Ce6) conjugated polymers onto Mn²⁺ ion-doped
 39 NaY(Mn)F₄:Yb,Er nanocrystals (Y : Mn : Yb : Er = 50 : 30 : 18 : 2).
 40 The strong UC emission at *ca.* 660 nm under 980 nm excitation
 41 well overlaps the absorption peak of Ce6 that, being a PDT
 42 sensitizer, is consequently activated. Again the dual modal
 43 optical/MR imaging allows the localization of the nanoprobe
 44 that demonstrate remarkably enhanced cell internalization and
 45 tumor-homing, thanks to an outer layer of the charge-reversible
 46 pH sensitive polymer.

47 As a last example NIR light has been used to phototrigger
 48 drug release from yolk-shell structured mesoporous silica
 49 nanocages containing UCNPs (NaYF₄:Tm³⁺,Yb³⁺@NaLuF₄)
 50 and a prodrug.⁸¹ This last species is able to release the drug
 51 after photolysis induced by the upconversion emission light.
 52 The authors demonstrated the possibility of photoregulated
 53 drug release in living animals with a system characterized by a
 54 high drug-loading capacity.

55 All the examples discussed so far have been based on the
 56 Yb³⁺ sensitizer and therefore involve a laser excitation at

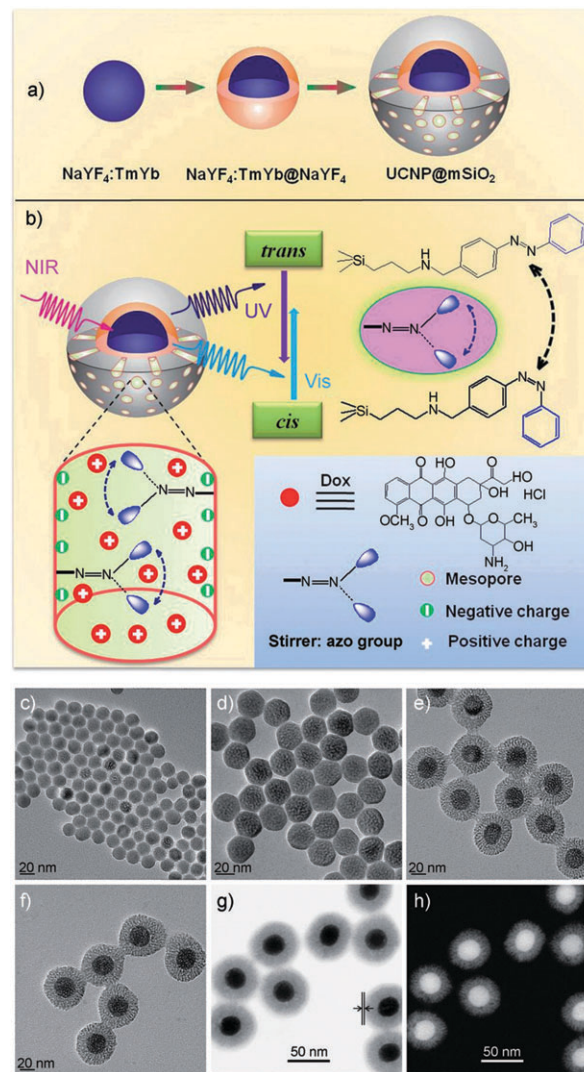

Fig. 6 (a) Synthetic procedure for upconverting nanoparticles coated with a mesoporous silica outer layer. (b) NIR light-triggered Dox release mediated by the upconversion property of UCNPs and *trans-cis* photoisomerization of azo molecules grafted in the mesopore network of a mesoporous silica layer. TEM images of (c) NaYF₄:Tm, Yb, (d) NaYF₄:Tm, Yb@NaYF₄, (e) NaYF₄:Tm, Yb@NaYF₄@mSiO₂, and (f) NaYF₄:Tm, Yb@NaYF₄@mSiO₂-azo. (g) Bright-field and (h) dark-field STEM image of TAT-modified NaYF₄:Tm, Yb@NaYF₄@mSiO₂-azo. Adapted from ref. 78 Copyright 2013 Wiley-VCH Verlag GmbH & Co. KGaA, Weinheim.

980 nm. Since a few years it has been evidenced and taken into account by many groups that at this wavelength some non-negligible overheating problems can rise, especially when high power lasers are used. This light energy, in fact, exactly matches the gap between the NIR 1 and the NIR 2 windows, a range where water presents an absorption peak. Therefore, in bioimaging applications, the water absorption at 980 nm of the excitation beam first of all can be detrimental for depth penetration but, due to the dissipation as heat, it can also cause dramatic tissue damage depending on the laser power and the irradiation time. This is well evidenced by the fact that laser interstitial thermal therapy (LITT), a therapy where tissues

necrosis is obtained *via* laser induced local increase of temperature, is often realized by 980 nm diode lasers.^{89,90} For this reason, in the last few years there is growing attention on systems that can be excited at wavelengths where water does not absorb.

A pioneering computational and experimental study of He and co-workers⁹¹ has evidenced that NaYbF₄:Yb³⁺/Tm³⁺ UCNPs encapsulated in a PEG derivative are suitable for *in vivo* whole body imaging of nude mouse under an excitation wavelength of 915 nm. Moreover, the study of the temperature distribution on mouse skin after various irradiation times showed that there is a significant difference in the temperature rise with respect to 980 nm excitation. A careful comparison of the *in vivo* data and of the performance of the NPs in phantom tissue revealed that the excitation at 915 was advantageous in terms of depth penetration and minimal excitation power density required, with a consequent much reduced overheating. Other excitation wavelengths have been proposed, for example for LiYF₄:Er³⁺10% that under 1490 nm low power light present a total UC QY higher than the one of NaYF₄:20%Yb³⁺/2%Er³⁺ nanocrystals under excitation at 980 nm.⁹²

More recently, however, it has been evaluated that an excitation matching the local minimum of water absorption spectra at around 800 nm could be considered an ideal one, inducing the least damage to the biological environment. To this goal UCNPs have been carefully engineered and thanks to cascade sensitization and Nd ion doping, it has been possible to prepare stable and highly emitting systems under excitation at 800 nm. Nd³⁺ has, in fact, a large absorption cross section at this wavelength, which presents the double advantage to be in a range where water and other biomolecules have the minimum adsorption and to be covered by commercial easily available and low cost CW lasers with good performance. In a first example Han and co-workers⁹³ have found that first of all, due to the rather complicated excited Nd³⁺ states, its doping concentration needs to be optimized for each combination. They showed that β-NaYF₄:1%Nd,30%Yb,0.5%Tm NPs presented the best balance among the component but still a low UC efficiency. Taking into account the high surface to volume ratio in nano-objects and the consequent greater surface quenching risk, it is essential to prevent these deactivations *via* core-shell strategy. They grew an inert β-NaYF₄ layer on the UCNP core for a total average diameter of 29 nm and a *circa* 20-fold enhancement of the emission yield. The final result was a much lower heating effect of water under 800 nm excitation and a comparable UC luminescence intensity with other similar systems. In this case the tri-dopant UCNPs present all the Ln³⁺ in the core while the shell is un-doped. A different strategy was followed by Yan, Sun and co-workers⁹⁴ that distributed the three components (Nd, Yb and Er ions) in two couples: Nd/Yb in the shell and Yb/Er in the core, both layers of the NaGdF₄ matrix. In their investigation they found that Nd³⁺ is an irreplaceable sensitizer in order to have an efficient excitation at *circa* 800 nm, and that the emission intensity of the UCNPs increases with their increasing concentration but at high doping degrees (>10%) there are two detrimental effects:

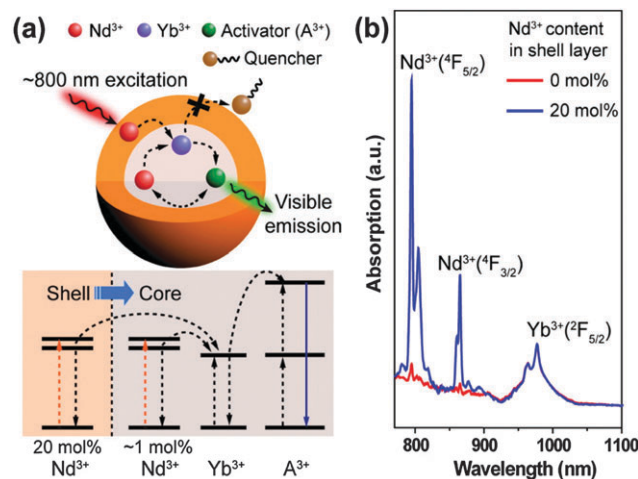

Fig. 7 (a) Schematic design (top) and a simplified energy level diagram (bottom) of a core-shell nanoparticle for photon upconversion under 800 nm excitation. Nd³⁺ ions doped in the core and shell layers serve as sensitizers to absorb the excitation energy and subsequently transfer it to Yb³⁺ ions. After energy migration from the Yb³⁺ ions to activator ions, activator emission is achieved via the Nd³⁺-sensitization process. (b) Near-IR absorption spectra of NaYF₄:Yb/Nd(30/1%) nanoparticles coated with an inert NaYF₄ shell or an active NaYF₄:Nd(20%) shell. The absorption spectra were normalized at 976 nm for comparison. Adapted from ref. 95 Copyright 2013 American Chemical Society.

self-quenching and Nd³⁺ quenching of the Er emission. To minimize these drawbacks Nd³⁺ and Er³⁺ were separated into two different layers and the co-doping with Yb³⁺ of both of them ensured an efficient sensitizer-activator energy transfer. In this design the activator is shielded and protected by the surface quenching but it is also kept far from the Nd ions to decrease possible energy back-transfer processes. This strategy has yielded an UC emission efficiency suitable for *in vivo* imaging of nude mouse under 800 nm excitation and without overheating side effects. Liu and co-workers⁹⁵ have proposed another distribution of almost the same components in order to further enhance the ET efficiency pushing further the doping degree of Nd³⁺. They used the NaYF₄ matrix to prepare core-shell NaYF₄:Yb/Tm/Nd@NaYF₄:Nd NPs with 2% Nd in the core and 20 mol% of total Nd³⁺ considering also that the active shell is present (Fig. 7).

The integrated emission intensity increased of more than 400 times adding the Nd³⁺ layer coating on the core, a better result in comparison with the ones obtained with core-shell systems with an inert outer shell. Nevertheless, the energy back-transfer was still a challenge and Yao, Ma, Zhao, Gu and co-workers⁹⁶ have carefully investigated the possibility to further reduce this quenching effect and maximize the concentration of the Nd sensitizer. They started from the same structure and components of the previous example but they implemented the system adding a second spacer-layer between the core (containing the Yb³⁺ and the activator ions) and the outer shell, presenting the Nd in the matrix (around 90% of the concentration) and doped with Yb³⁺. The intermediate layer acts as a shield to prevent the energy back-transfer increasing the distance between Nd³⁺ and Er³⁺ and contains a certain amount of

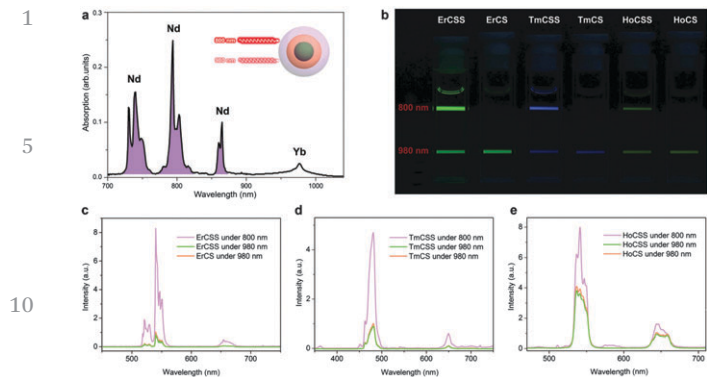

Fig. 8 Photoluminescence comparison of Nd-sensitized quenching-shield sandwich UCNP (exc. 800 nm) and conventional Yb-sensitized core-shell UCNP (exc. 980 nm). (a) Absorption spectra in hexane (20 mg mL^{-1}). (b) Luminescence photographs of UCNP with different activator ions (Er^{3+} , Tm^{3+} , and Ho^{3+}) excited at 800 nm (top) and 980 nm (bottom) with 0.5 W cm^{-2} diode lasers. (c) UC emission spectra of the ErCSS nanoparticles (excitation at 800 and 980 nm) and the ErCS nanoparticles (excitation at 980 nm). (d) UC emission spectra of $\text{NaYF}_4:20\%\text{Yb},0.5\%\text{Tm}@NaYF_4:10\%\text{Yb}@NaNdF_4:10\%\text{Yb}$ (TmCSS) nanoparticles (excitation at 800 and 980 nm) and $\text{NaYF}_4:20\%\text{Yb},0.5\%\text{Tm}@NaYF_4$ (TmCS) nanoparticles (excitation at 980 nm). (e) UC emission spectra of $\text{NaYF}_4:20\%\text{Yb},0.5\%\text{Ho}@NaYF_4:10\%\text{Yb}@NaNdF_4:10\%\text{Yb}$ (HoCSS) nanoparticles (exc. at 800 and 980 nm) and $\text{NaYF}_4:20\%\text{Yb},0.5\%\text{Ho}@NaYF_4$ (HoCS) nanoparticles (excitation at 980 nm). Note that the ErCSS, TmCSS, and HoCSS samples were synthesized under the same conditions and the ErCS, TmCS, and HoCS samples were prepared by using the same synthetic method. All the above samples were dispersed in cyclohexane at the same concentration (20 mg mL^{-1}). The power density of both lasers is 0.5 W cm^{-2} . Adapted from ref. 96 Copyright 2009 Wiley-VCH Verlag GmbH & Co. KGaA, Weinheim.

Yb^{3+} ions to ensure the migration of the direct energy transfer from the sensitizer to the activator.

The authors investigated the influence of the interlayer thickness on the final UC emission intensity and they have found the best balance of the back and forth ET was obtained for a 1.5 nm one. The final $\text{NaYF}_4:\text{Yb}_{0.2},\text{Er}_{0.02}@NaYF_4:\text{Yb}_{0.1}@NaNdF_4:\text{Yb}_{0.1}$ NPs, or the corresponding ones bearing Tm^{3+} or Ho^{3+} as activators, under 800 nm excitation, have UC luminescence higher than the corresponding $\text{NaYF}_4:\text{Yb}_{0.2},\text{Er}_{0.02}@NaYF_4$ NPs sensitized directly *via* Yb^{3+} (Fig. 8).

Also in this case, the evaluation of the ability of the UCNP to penetrate tissue by *in vivo* imaging of nude mouse revealed for the Nd^{3+} sensitized NPs excited at 800 nm a higher penetration depth and a much lower undesirable overheating than the 980 nm-excited Yb^{3+} sensitized NPs. These last examples involve highly engineered UCNP with optimized excitation features but have the partial drawback that the emission light is mostly in the visible range of the spectrum. A very promising strategy that is now extensively explored to overcome also this problem is to exploit lanthanide doped NPs for DS emission, a very interesting topic that needs a separate discussion.

2.2 DS NPs: Stokes-emitting NPs in the NIR-1 and NIR-2 regions

In the DS emitting nanocrystals the co-doping strategy is rarely adopted and the Ln^{3+} ions commonly used are those presenting

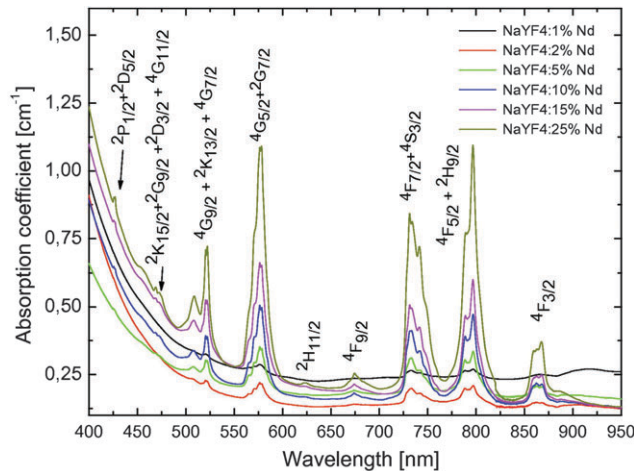

Fig. 9 Room temperature absorption spectra of NaYF_4 colloidal nanocrystals doped with various amounts of Nd^{3+} (1, 2, 5, 10, 15 and 25%). The bands are assigned to the transitions from a ground state $^4I_{9/2}$ to the indexed excited ones. Adapted from ref. 97 Copyright 2011 Elsevier Ltd.

significant visible emission under UV excitation, that is to say Sm^{3+} , Eu^{3+} , Tb^{3+} and Dy^{3+} . However, for *in vivo* imaging, the need of having both the excitation and detection wavelength in the *biological optical transparency window* has led to the choice of Nd^{3+} as an emitting unit.

In fact, as it can be seen from Fig. 9, Nd^{3+} can be conveniently excited in the NIR-1 region, and in particular at around 800 nm, where this ion has a relatively high good absorption cross section.

At the same time, the luminescence spectrum of Nd^{3+} ions presents three possible transitions ($^4F_{3/2} \rightarrow ^4F_{9/2}$ in the NIR-1 and $^4F_{3/2} \rightarrow ^4F_{11/2}$ and $^4F_{3/2} \rightarrow ^4F_{13/2}$ in NIR-2), at around 900, 1050 and 1300 nm, respectively, with luminescence quantum yields that in NPs, summing up the three contributions, can be as large as 80% (Fig. 10).^{95,97,98}

The luminescence of Nd^{3+} doped NPs has been reported in the last few years by several groups for core and core-shell NPs.

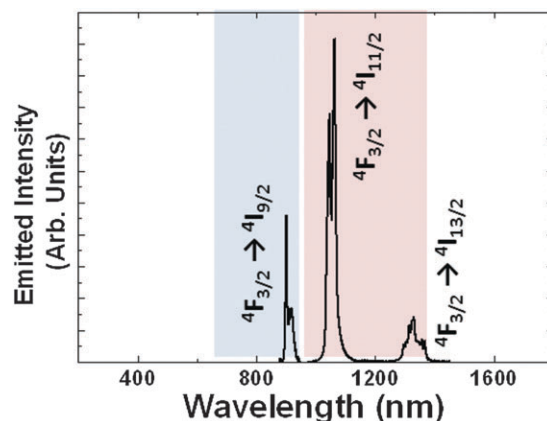
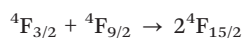

Fig. 10 Emission spectrum of a colloidal solution of $\text{Nd}^{3+}:\text{LaF}_3$ NPs obtained after 808 nm optical excitation. NIR-1 (blue) and NIR-2 (pink) biological windows are schematically labeled. Adapted from ref. 31 Copyright 2014 Wiley-VCH Verlag GmbH & Co. KGaA, Weinheim.

1 The optical properties of $\text{YF}_3:\text{Nd}^{3+}$ NPs, prepared by solvothermal decomposition of trifluoroacetate precursors in high boiling point solvents, have been investigated by Tan *et al.*⁹⁹ These NPs, that have a size of about 20 nm, showed a fluorescence quantum yield and an excited state lifetime that was highly dependent on the concentration of the dopant. In particular, the luminescence spectra and the excited state decays have been recorded for concentrations ranging from 0.25 mol% \leq Nd \leq 5 mol%. In this range, the quantum yield dropped from about 75% to less than 5%, while, at the same time, the average lifetime passed from 588 to 6 μs . This is a behaviour that is common to all Nd^{3+} doped NPs and can be attributed to two concomitant energy transfer processes, *i.e.*, cross relaxation (CR) and energy migration (EM), whose overall efficiency varies with the square of dopant concentration.

In CR, the luminescent $^4\text{F}_{3/2}$ excited state transfers only part of its energy to a Nd^{3+} ion in the $^4\text{F}_{9/2}$ ground state to give two ions in the $^4\text{F}_{15/2}$ state, leading to a decrease of the luminescence, according to the following scheme:



In the case of energy migration, all the energy of a $^4\text{F}_{3/2}$ state is transferred from a Nd^{3+} ion to a neighbouring one and so on. In this way the excitation energy is not lost; however, this process increases the probability that a Nd ion present at (or close to) the surface could be excited; since these ions can be efficiently quenched by surface effects (ligands, solvent molecules, and surface defects), they behave as an energy sink, thus greatly decreasing the overall luminescence quantum yield. The negative effects of energy migration can be minimized, as also discussed for UCNPs, with the epitaxial growth of an undoped outer shell that can efficiently shield these Nd^{3+} ions from surface quenchers.¹⁰⁰ This is a very interesting strategy, which has been followed by different authors. For example, Xie *et al.*¹⁰¹ have investigated Nd^{3+} doped LaF_3 nanocrystals prepared by a surfactant-free aqueous solution route. In this case, the authors showed that core-shell NPs prepared by coating the same NPs with an outer LaF_3 shell showed a 60% intensity increase at 1056 nm with respect to the uncoated NPs.

In this context, another very interesting example has been proposed by Prasad and co-workers that synthesised small core-shell oleate-capped core-shell $\text{NaGdF}_4:\text{Nd}^{3+}/\text{NaGdF}_4$ NPs¹⁰⁰ (average diameter 15 nm) with efficient NIR-to-NIR down shifting PL ($\lambda_{\text{ex}} = 740$ nm, $\lambda_{\text{em}} = 850$ –900 nm) for *in vitro* and *in vivo* imaging.¹⁰⁰ They adapted a previously reported synthetic method bearing hexagonal-phase core-shell $\text{NaYF}_4:\text{Yb},\text{Tm}@\text{NaYF}_4:\text{Yb},\text{Er}$ nanocrystals containing Tm and Er in the core and in the shell, respectively.¹⁰² In this case they take advantage of a NaGdF_4 shell covering a $\text{NaGdF}_4:\text{Nd}^{3+}$ core to suppress non-radiative recombination processes at the NP surface. More in detail, to optimize the overall signal of the NPs, the authors have adopted two sequential steps. The first one was based on the optimization of the brightness of the $\text{NaGdF}_4:\text{Nd}^{3+}$ core upon varying the Nd^{3+} concentration. In particular, they found that in hexane the photoluminescence

quantum yields of these nanostructures doped with a 3, 6, 10, and 15% of the emitting ion were estimated to be about 22, 9.4, 5.0 and 3.6%, respectively, suggesting that the highest brightness (that has to take into consideration also the absorbance of Nd^{3+} and thus is concentration) could be obtained with a 3% doping degree. The authors also showed that lowering even further the concentration of the dopant to 1% could not take to an additional increase of the quantum yield. Once optimizing the Nd concentration, the authors grew a 2 nm thick shell of NaGdF_4 obtaining in this way NPs showing a QY as high as 40%. The effect attributable to the shell is thus a 86% increase of the luminescence, very close to the effects previously discussed. A parallel increase in the excited state lifetime from 190 to 240 μs was also observed. For biological applications, these NPs were then transferred to the aqueous phase by the ligand-free method; in this condition however the QY resulted to be two times lower (and the excited state accordingly shorter) because of the multi-phonon deactivation process due to the high energy of the O–H oscillators, suggesting that the shell used for these NPs does not provide an absolute protection for the Nd^{3+} ions against surface effects.

The NIR-to-NIR bioimaging was successfully demonstrated *in vivo* through visualization of the emission at 900 nm upon Xe lamp excitation from a band-pass optical filter (710–760 nm).¹⁰⁰ In this experiment the NPs were injected subcutaneously into a mouse and the luminescence imaging was measured using a CCD camera (Fig. 11). A bright emission was clearly visible at the injection point, while almost no autofluorescence was observed elsewhere, resulting in a high contrast image.

An exhaustive and rigorous study on the optimization of the best conditions for efficient bioimaging with DS nanoparticles based on Nd^{3+} ions has been performed by Jaque and co-workers.^{31,103,104} They synthesized Nd^{3+} doped LaF_3 nanocrystals having a diameter of 15 nm and a size dispersion close to 30% with different concentrations of the dopant to obtain the highest brightness, reached with a 15% Nd concentration.¹⁰⁴ An important subject of the study was to verify which of the three transitions observed in the luminescence spectrum, at around 900, 1050 and 1300 nm, could give the best signal under normal imaging conditions.³¹ The parameters to be considered are

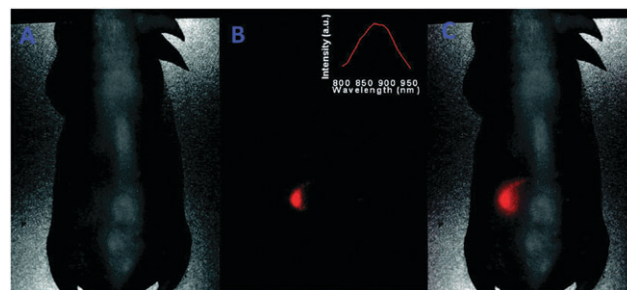

Fig. 11 3.5 *in vivo* whole-body image of a nude mouse subcutaneously injected with ligand-free $(\text{NaGdF}_4:3\%\text{Nd}^{3+})/\text{NaGdF}_4$ nanocrystals: (A) bright field image, (B) PL image, and (C) superimposed image (bright field image and spectrally unmixed PL image). (inset) Spectra of the NIR PL signals. Adapted from ref. 100 Copyright 2012 American Chemical Society.

three: (i) the relative intensity of each transition; (ii) the sensitivity of the detectors at the different wavelengths, and (iii) the transparency of tissues at each wavelength. As far as the relative intensity is concerned, for the system under study a relative intensity of 0.25, 0.60 and 0.15, respectively, was reported, while the sensitivity of the InGaAs array typically used for these experiments is, in arbitrary units, 0.4, 0.8 and 0.8, respectively. The tissue transparency was instead evaluated measuring the intensity transmitted by layers of phantom tissues (mimicking the optical properties of human skin) of different thicknesses. The obtained extinction coefficients, which take into account both absorption and scattering processes, are 7.9, 6.0 and 5.0. Summing up all terms, the ${}^4F_{3/2} \rightarrow {}^4F_{11/2}$ transition at around 1050 nm, in the second biological window, was shown to be the best for subtissue imaging, also if compared to the traditionally used ${}^4F_{3/2} \rightarrow {}^4F_{9/2}$ at 910 nm (first biological window). In addition, since in *in vivo* optical imaging the spatial resolution is restricted mainly by scattering processes, the use of the emission in NIR-2 could also be beneficial from this point of view. High tissue penetration (*ca.* 1 cm), observing the luminescence spot originating from injection points performed at different depth in mice, was then obtained in *in vivo* experiments.

Interestingly, the same group has also demonstrated that these Nd^{3+} doped core-shell LaF_3 NPs can be used as subtissue thermal sensors.¹⁰⁴ In fact, upon increasing the temperature, a gradual, small shift ($0.10 \text{ cm}^{-1} \text{ K}^{-1}$) of the band at 864 nm can be observed, accompanied by a change of the ratio of the intensities observed at 885 and 863 nm. Both these parameters can allow us to measure temperatures with a thermal resolution close to 2°C . Although this resolution is much lower than the one obtained with other systems,¹⁰⁵ it is possible to appreciate the temperature increase obtained in a single-beam plasmonic-mediated heating experiment, as described in Fig. 12. Gold nanorods were used as heaters, taking profit of their high absorbance at 808 nm, where also the NPs are excited, and the temperature monitored by the NIR Nd^{3+} emission, evidencing how the temperature induced spectral shift and intensity variation emission bands of the Nd^{3+} ions can be successfully monitored to estimate the local temperature. In addition, the same kind of Nd^{3+} doped LaF_3 NPs was studied¹⁰³ also for their photo-thermal properties. In this case, however, the NPs were activated with an even larger amount of Nd^{3+} ions, up to 25%, decreasing in this way the brightness of the system (because of the decrease of the QY observed at high dopant concentration), but largely increasing the ability to generate heat under optical excitation at around 800 nm. In this way, with the same NP it has been possible to generate an increase of the local temperature in a chicken breast tissue, an increase that could be concomitantly monitored *via* the observed luminescence. This is an interesting proof of principle for the development of theranostic platforms based only on radiation light in the NIR-1 biological window.

A very recent paper by Villa *et al.*¹⁰³ reported an investigation of $\text{SrF}_2:\text{Nd}^{3+}$ NPs for *in vivo* imaging in the NIR-2 biological window.

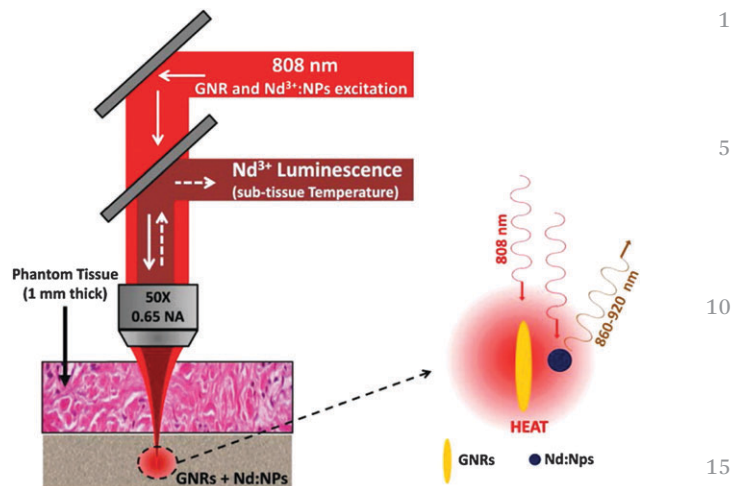

Fig. 12 Schematic representation of the experimental setup used for single-beam sub-tissue-controlled hyperthermia. A 808 nm laser beam is focused into an aqueous solution containing GNRs (nanoheaters) and $\text{Nd}^{3+}:\text{LaF}_3$ nanoparticles (nanothermometers). The solution was placed under a 1 mm thick phantom tissue. The luminescence of $\text{Nd}^{3+}:\text{LaF}_3$ nanoparticles was collected by using the same objective, and the subtissue temperature was extracted from its spectral analysis. Diagram at the right reflects the fact that both GNRs and $\text{Nd}^{3+}:\text{LaF}_3$ NPs were simultaneously excited by the 808 nm radiation. Adapted from ref. 104 Copyright 2013 American Chemical Society.

The particles were prepared by an environmentally friendly technique, using water as a solvent and relatively low treatment temperatures. Upon excitation at 808 nm with a diode laser, the emission band at 1340 nm of the Nd^{3+} ion was used to measure *in vivo* and *ex vivo* optical images of mice after intravenous administration of a colloidal dispersion of the $\text{SrF}_2:\text{Nd}^{3+}$ particles.

This investigation showed a negligible overlap between the emission band at 1340 nm of the Nd^{3+} ions and the infrared autofluorescence due to the food commonly used to feed the mice. The particles have been found to accumulate mainly in the liver and spleen, as shown in Fig. 13.

Nd^{3+} doped bimodal GdF_3 NPs were also investigated by Sardar *et al.*,^{106,107} and their fluorescence and magnetic properties have been demonstrated. The NPs (average size $\sim 5 \text{ nm}$) were prepared by thermal decomposition and subsequently coated with poly(maleic anhydride-*alt*-1-octadecene), PMAO, to increase the water solubility and the cellular uptake. The absolute QY of the Nd^{3+} emission in the 850–1400 nm range for the $\text{GdF}_3:\text{Nd}^{3+}$ powders resulted to be $10.2 \pm 1.6\%$ upon an excitation wavelength of 800 nm and an excitation power density of 12 W cm^{-2} . It is important to note that, differently from other cases, the authors noted a dependence of the QY on the excitation power density. The functionalized NPs form stable colloids and their cellular uptake has been tested on fibroblast cells. By placing the NPs under pig skin of different thicknesses, they could observe a clear signal also at the highest tested thickness (5 mm). In addition, they also found that the DS QY of these NPs were 2000 times higher than that of UC $\beta\text{-NaYF}_4:20\%\text{Yb}^{3+}/2\%\text{Er}^{3+}$ of the same size.

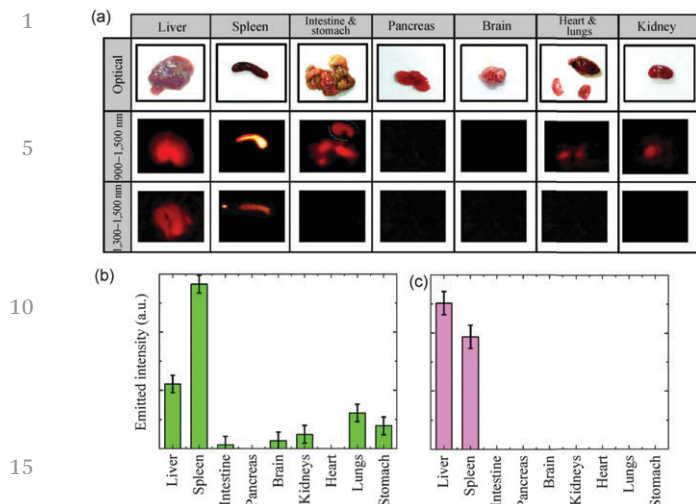

Fig. 13 (a) Optical and fluorescence images in the 900–1500 and 1300–1500 nm spectral detection ranges of the organs extracted from a sacrificed mouse 1 hour after an intravenous injection of Nd:SrF₂ particles. (b) 900–1500 nm integrated fluorescence intensity obtained from the different organs. (c) 1300–1500 nm integrated intensity obtained from the different organs. In all cases, the integrated fluorescence intensity has been normalized by the organ weight. Adapted from ref. 103 Copyright 2014 Springer.

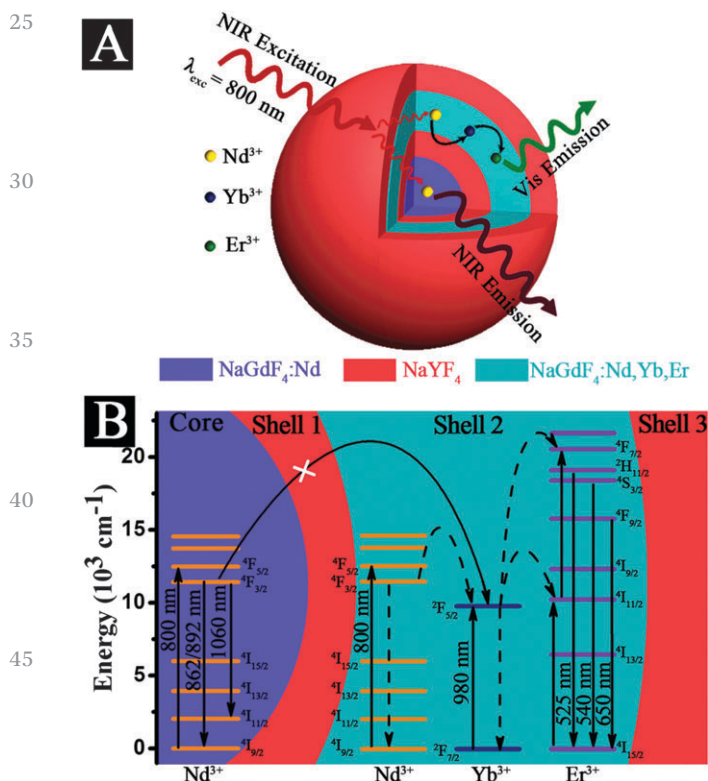

Fig. 14 (A) General strategy to achieve the UC and DS dual-mode luminescence with multi-layer C/S1/S2/S3 β -NGdF₄:Nd/NaYF₄/NaGdF₄:Nd,Yb,Er/NaYF₄ NPs. (B) Proposed energy transfer mechanisms in the multi-layer core-shell NPs. Adapted from ref. 109 Copyright 2013 Macmillan Publishers Limited.

other authors. The advantages of DSNPs are many: first of all, the luminescence quantum yield of these nanostructures is substantially higher. Besides this, the linear dependence of the emitted light on the excitation intensity – differently to what observed for bi-photonic processes – leads to a larger penetration depth and the possible use of light sources with a relatively low density, a feature that decreases possible biological damage. To take profit of all these features for *in vivo* imaging, but having an additional signal in the visible region for *in vitro* experiments, Li *et al.*^{108,109} prepared NaGdF₄ based multishell dual mode (UC and DS) NPs. In particular, as schematized in Fig. 14, these NPs are made of one core and three different shells with a C/S1/S2/S3 structure. The two active parts are the core C (β -NaGdF₄:Nd) and the second shell S2 (NaGdF₄:Nd,Yb,Er) that were designed for DS and UC luminescence, respectively, both at $\lambda_{exc} = 800$ nm. Passive shells S1 and S3 (NaYF₄) were added to prevent surface deactivation and, in the case of S1, possible energy transfer processes to the ions in the active shells. C was responsible for the typical Nd centred luminescence, which was conveniently used for the *in vivo* imaging of a nude mouse upon low excitation intensity, while S2 was responsible for the green fluorescence at 540 nm used for the *in vitro* imaging of human lymphocytes cells.

3. Lanthanide-based nanoparticles as MRI contrast agents

Since the seminal paper of Lauterbur¹¹⁰ in 1973, Magnetic Resonance Imaging (MRI) has rapidly emerged as one of the most powerful routine diagnostic tools in medicine, its strength being based on the non-invasive nature, the high spatial resolution accompanied by tomographic capabilities, and the absence of ionizing electromagnetic radiation.

The principles behind such a technique lie in the combined use of a static magnetic field B_0 and magnetic field gradients arranged in such a way that the physical space which encloses the sample magnetization (typically originating from water protons) is mapped into a frequency space of resonating spins. The basic radio-frequency pulse schemes used in MRI to manipulate the sample magnetization are sensitive just to the proton spin density, and are generally of limited use in the imaging of complex tissues or organs. More frequently, contrast is enhanced by T_1 or T_2 editing techniques, *i.e.* by using pulse sequences that are sensitive, as well as the spin density, also the longitudinal (T_1) or transverse (T_2) relaxation times of protons. These two time constants come at play whenever the magnetization created by the external field B_0 is moved away from its equilibrium value. Within a phenomenological approach, the decay of the z -magnetization towards its thermal equilibrium value is governed by the longitudinal relaxation time, whereas the same decay relative to the x - and y -magnetization components is governed by the transverse relaxation time. For small, rapidly tumbling molecules in the solution state it is found that $T_1 = T_2$ (fast motion limit).

A preference for NIR-to-NIR DSNPs with respect to NIR-to-NIR UCNPs for *in vivo* imaging has been evidenced also by

When the characteristic relaxivity of protons within different domains is not sufficient to provide an informative image, the use of paramagnetic contrast agents (CAs) can lead to a considerable enhancement of the anatomic or pathologic details under investigation. The reason for this enhancement lies in the fact that, when the contrast agents (usually, metal chelates of paramagnetic ions) accumulate in a certain tissue or region, the water protons of that region experience a significant relaxation increase, which can easily be detected in T_1 -weighted imaging sequences. For these reasons, contrast agents are important diagnostic tools used in more than 30% of all clinical MRI scans. However, as will be seen from the theory, the efficacy of a typical Gd(III) small chelate (such as, for example, gadodiamide) is quite limited, and a relatively large local concentration of CA is required to obtain a significant contrast.

As a further complication, the design of all CA must cope with the possible toxicity of paramagnetic ions – notably Gd(III) among other lanthanides – and with the body excretion capabilities. Highly stable Gd(III) complexes are routinely used as CAs, yet not without insidious shortcomings. First, the gadolinium ion may coordinate regions of partial charge on proteins or macromolecular substrates and, as a consequence of such binding, the relaxivity of the CA can vary significantly due to the altered rotational and exchange dynamics. Second, the rapid tumbling of a small complex reduces the efficiency of the relaxation agent, as will be seen from the theory. To alleviate this problem, a variety of slow-tumbling water-soluble complexes with Gd(III) ions have been originally devised with the aim of obtaining high water relaxivities at the lowest possible concentrations. Such macromolecular species include zeolites, micellar aggregates, polyamino acids, polysaccharides, dendrimers and, more recently, nanoparticles based either on lanthanide compounds or functionalised with lanthanide ion chelates.¹¹¹

3.1 Theoretical highlights

The CA operating mechanism takes advantage of a phenomenon known as paramagnetic relaxation enhancement (PRE) of longitudinal and transverse relaxation rates. The interested reader can find a thorough treatment of PRE in books by Bertini¹¹² and Kowalewski,¹¹³ as well as in many technical reviews; to our scope, just the basics of the theory will be recalled in this section.

Solution-state NMR used by chemists mostly deals with diamagnetic species, *i.e.* species in which the pairing of the electron spins cancels out the electron magnetism.¹¹⁴ The strong magnetism of paramagnetic (and ferromagnetic) species is rather due to the presence of unpaired electron spins. In the presence of a magnetic field, the unpaired electron spins behave in a similar way to the nuclear spins, one major difference being that the electronic magnetic moment is about 650 times that of the proton. Just as the longitudinal and transverse relaxation of nuclear spins are driven by random fluctuations of the dipolar coupling between the nuclei, PRE is caused by fluctuations of the electron spin–nuclear spin interactions.

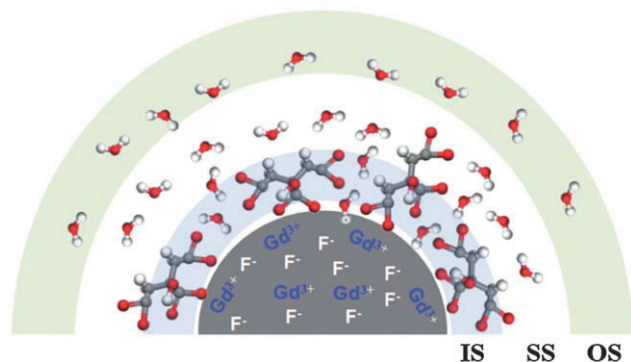

Fig. 15 Schematic representation of a GdF₃ nanoparticle coated with citrate in water medium. IS = inner sphere; SS = second sphere; OS = outer sphere. Adapted from ref. 115 Copyright 2013 The Royal Society of Chemistry.

In solutions of paramagnetic ions or complexes, the ligands carrying nuclear spins (*e.g.* water) can reside in two types of environment, namely in the coordination sphere of the paramagnetic ion or in the bulk solution. PRE for each of these two scenarios is conveniently treated in different ways: “inner-sphere” relaxation refers to the relaxation enhancement of a solvent molecule directly coordinated to the paramagnetic ion, and “outer-sphere” relaxation refers to the relaxation enhancement of non-coordinated solvent molecules (namely, the bulk solvent). An intermediate situation, the “second-sphere” relaxation mechanism, generally refers to PRE of water not directly bound to the paramagnetic ion, but to other H-bonding groups in close proximity to the ion (*e.g.* carboxylates, see Fig. 15).

It is important to point out that the PRE effects discussed below can affect T_1 or T_2 (or even both) in distinct amounts, depending on the chemistry of the paramagnetic relaxing agent. In the following discussion, the Gd(III) ion in water will be taken as the paradigm of a T_1 relaxing agent: accordingly – and for the sake of simplicity – only the theoretical formulations relative to T_1 will be explicitly mentioned. The analogous expressions for T_2 can be found in specialized books.^{112,113}

3.2 Inner-sphere relaxation

For a dilute solution of paramagnetic species like Gd(III) in water, the inner-sphere contribution to PRE is given by the quantity

$$T_{1P}^{-1} = \frac{P_M}{\tau_M + T_{1M}} = R_{1P} \quad (1)$$

where P_M is the mole fraction of bound water nuclei ($P_M = [\text{Gd(III)}]q/55.6$ with q the number of binding sites in the complex¹¹¹), τ_M is the lifetime of the water in the complex and T_{1M} is the longitudinal relaxation time of the bound water protons. Note that τ_M is a limiting factor for the propagation of PRE from the paramagnetic site to the bulk water. For non-binding paramagnetic complexes, the inner-sphere contribution is null by definition, whereas in the fast-exchange limit ($\tau_M \ll T_{1M}$) the enhanced relaxivity depends on the relaxation time for the coordinated solvent molecules.

The quantity T_{1M} is made up of two contributions, namely a Fermi-contact (or scalar) one and a dipolar one. With some convenient approximations, T_{1M} can be estimated by means of the Solomon–Bloembergen equations as

$$T_{1M}^{-1} = (T_{1M}^{FC})^{-1} + (T_{1M}^{DD})^{-1} \quad (2)$$

$$(T_{1M}^{FC})^{-1} = \frac{2}{3} A_{FC}^2 S(S+1) \frac{\tau_{e2}}{1 + (\omega_S - \omega_I)^2 \tau_{e2}^2} \quad (3a)$$

$$(T_{1M}^{DD})^{-1} \approx \frac{2}{15} \frac{K_{IS}^2}{r_{IS}^6} S(S+1) \left[\frac{7\tau_{c2}}{1 + \omega_S^2 \tau_{c2}^2} + \frac{3\tau_{c1}}{1 + \omega_I^2 \tau_{c1}^2} \right] \quad (3b)$$

In eqn (3a) the constant A_{FC} represents the scalar part of the Fermi contact interaction (*i.e.* the electron-nuclear hyperfine coupling constant), a quantity which is proportional to the density of “unpaired electron spin” at the site of the nucleus under investigation. The correlation time $\tau_e = (\tau_M^{-1} + T_{2e}^{-1})^{-1}$ takes into account the exchange lifetime of the complex (τ_M) and the electron transverse relaxation time (T_{2e}). In eqn (3b) r_{IS} is the distance between the observed nucleus and the paramagnetic centre, where it can be defined. In addition, the above equations are formulated for a generic electron spin whose quantum number S should be substituted by the spin-orbit J quantum number in the case of lanthanides. The constant K_{IS} is the (electron–nuclear) dipole–dipole coupling constant

$$K_{IS} = -\frac{\mu_0}{4\pi} \gamma_I \gamma_S \hbar \quad (4)$$

γ_i being the magnetogyric ratio of the nucleus ($i = I$) or the electron ($i = S$) and μ_0 the permeability of vacuum. Again, the product $\gamma_S \hbar$ should be substituted with $g_I \mu_B$ for the case of lanthanides, where μ_B is the Bohr magneton.

It follows from the previous statements that the Fermi-contact contribution vanishes “through bonds” (yet in a non-systematic way), whereas the dipolar contribution rapidly vanishes “through space” as the distance r_{IS} grows.

A prominent role in determining the relaxation properties is played by the correlation time quantities τ_i : as a general rule, if more than one (uncorrelated) processes modulate a single interaction, the inverse of the resulting correlation time is a sum of the rates of the single processes responsible for the loss of correlation. For the dipolar part there exist two relevant correlation times, namely τ_{c1} and τ_{c2} , defined as

$$\tau_{ej}^{-1} = \tau_R^{-1} + \tau_M^{-1} + T_{je}^{-1}; \quad j = 1, 2 \quad (5)$$

which incorporate the rotational correlation time τ_c and the exchange lifetime of the complex together with the electron longitudinal (T_{1e}) or transverse (T_{2e}) relaxation times.

The ultimate goal in the design of highly efficient CAs is essentially related to shortening T_{1P} as much as possible. Apart from increasing the number of binding sites q , a straightforward way to increase the relaxivity of Gd(III) complexes is to shorten T_{1M} . This goal can be achieved by increasing the rotational correlation time (see eqn (3b) and (5)), that is by increasing the size of the complex. The effect of this strategy is well illustrated in Fig. 16: the interaction between the complex

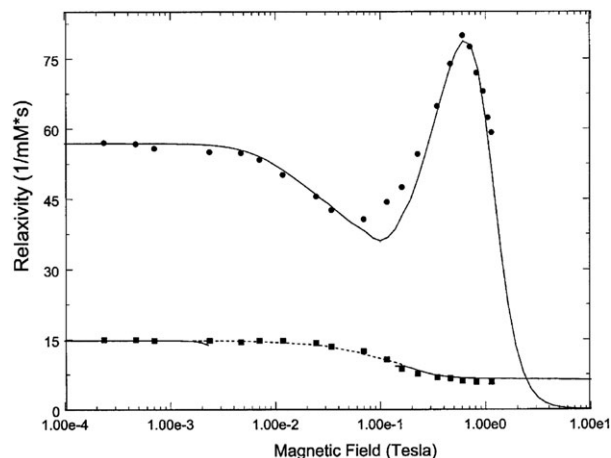

Fig. 16 Experimental and calculated nuclear magnetic relaxation dispersion (NMRD) profiles for Gd–EDTA[−] in aqueous solution in the presence (solid circles) and absence (solid squares) of the bovine serum albumin. Adapted from ref. 116 Copyright 2003 Elsevier Ltd.

Gd–EDTA[−] and bovine serum albumin clearly raises the relaxivity and modifies the dispersion profile.

3.3 Outer-sphere relaxation

As the exchange lifetime τ_M becomes increasingly shorter, a limit situation is reached where a binding site no longer exists and the paramagnet–ligand interaction is modulated only by random encounters between the molecules, under diffusion control. In other words, the solvent (water) molecules can also experience PRE even in the absence of coordination to the paramagnetic species. This second mechanism is generally called “outer-sphere” relaxation and, differently from the inner-sphere intramolecular mechanism, it is driven by the stochastic variation of the intermolecular nuclear spin–electron spin distance. In fact, pure “outer-sphere” relaxation arises just from the modulation of the electron–nuclear dipolar coupling by translational diffusion of water molecules around the Gd(III) complex. In between the “inner-sphere” and “outer-sphere” mechanisms, a “second coordination” (or secondary-sphere) effect has sometimes been invoked, yet hardly quantified.^{117,118} Within this picture, contact shifts no longer exist, and the dipolar shifts average to zero (if the approach to the paramagnetic ion can occur in every direction).¹¹² As compared to eqn (1), the equations describing T_1 for the outer-sphere relaxation are quite different, although a general factorization into a constant term and a dynamic term can still be identified. The characteristic time for the modulation of the interaction energy becomes the diffusional correlation time τ_D ,

$$\tau_D = \frac{d^2}{D_M + D_L} \quad (6)$$

where D_M and D_L are the diffusion coefficients of the Gd(III)-containing and ligand-containing (water) molecules, and d is the distance of closest approach between the Gd(III) and the water molecules. Note that, for very large (*e.g.* nanosized)

1 complexes, $(D_M + D_L) \sim D_L$ meaning that only the ligand (water) diffusion coefficient can influence τ_D .

Within the outer-sphere relaxation mechanism, two limiting situations apply, depending on whether the electronic relaxation time is shorter or longer than the diffusional correlation time.

10 In the case of fast electron relaxation, the solvent appears frozen on the timescale of the electron relaxation process. The outer-sphere contribution can be thus evaluated by integrating the dipolar part of the Solomon–Bloembergen eqn (3b) over the distance range between d and infinity, while noting that $\tau_{ej} = T_{je}$ from eqn (5). In doing this, the following equation results:

$$15 \quad T_{1M}^{-1} = \frac{2}{15} 1000 N_A [M] \frac{4\pi K_{IS}^2}{3 d^3} S(S+1) \times \left[\frac{7T_{2e}}{1 + \omega_S^2 T_{2e}^2} + \frac{3T_{1e}}{1 + \omega_I^2 T_{1e}^2} \right] \quad (7)$$

20 where $1000 N_A [M]$ is the concentration of the molecule bearing the paramagnetic centre in mol m⁻³, N_A being the Avogadro number. In this case, the relevant parameters are just the concentration and the longitudinal and transverse electronic relaxation times of the paramagnetic species. Also, different from the inner-sphere mechanism, the paramagnetic effects for the outer sphere mechanism are not reduced by the mole fraction P_M of bound solvent molecules.

In contrast to the previous case, in the diffusion-controlled regime the dipolar interaction is modulated only by the relative diffusion of the paramagnetic centre and the solvent spins. Eqn (7) thus can be rewritten as

$$30 \quad T_{1M}^{-1} = \frac{8}{135} 1000 N_A [M] \frac{4\pi K_{IS}^2}{3 d(D_M + D_L)} S(S+1) \times [7\mathcal{J}(\omega_S) + 3\mathcal{J}(\omega_I)] \quad (8)$$

35 where the quantities $\mathcal{J}(\omega_i)$ are the spectral densities for the modulation of the distance r by (uniform) translational diffusion. As has been pointed out in different contexts,^{119–121} such spectral densities scale as the inverse of the distance of closest approach d , rather than as the inverse sixth power of r (eqn (3b)), allowing PRE to reach long-range water spins.

40 Generally, for monoqua ($q = 1$), low molecular weight Gd(III) complexes at high fields, the outer-sphere contribution can account for nearly 50% of the relaxivity, whereas its contribution drops in macromolecular systems in the approximate frequency range 10–60 MHz.¹¹¹

3.4 Curie spin relaxation

45 The static magnetic moment $\langle \mu \rangle$ of a paramagnetic molecule interacts with the nuclear spins and introduces another relaxation mechanism. This contribution is important for large paramagnetic molecules with rapid electron spin relaxation, and can in certain situations prevail over the Solomon-like terms. Curie spin relaxation is modulated by reorientation and exchange dynamics of the paramagnetic complex, but not by its electron relaxation. In addition, since the magnetic moment depends on the square of the external magnetic field, Curie

spin relaxation increases with the square of the nuclear Larmor frequency ω_I , according to the equation

$$5 \quad T_{1M}^{-1} = \frac{2}{5} \left(\frac{\mu_0}{4\pi} \right)^2 \frac{\omega_I^2 g_e^4 \mu_B^4}{(3k_B T)^2 r_{IS}^6} S^2 (S+1)^2 \left[\frac{3\tau_r}{1 + \omega_I^2 \tau_r^2} \right] \quad (9)$$

where the constants and parameters have been already introduced in eqn (3) and (4), except for the Boltzmann constant k_B . As seen for the previous equations, the spin–orbit J quantum number should replace the quantum number S in the case of lanthanides. The quantity $S_C = \langle S_z \rangle = -g_e \mu_B S(S+1) B_0 / (3k_B T)$ appearing in eqn (9) is the magnitude of the “Curie spin”, namely the thermally averaged amount of spin S aligned along the external magnetic field B_0 . In this respect, the Curie spin S_C , the magnetic moment $\langle \mu \rangle$ and the molar susceptibility χ_M represent alternate viewpoints on the same phenomenon, being $\langle \mu \rangle = -g_e \mu_B S_C$ and $\chi_M = \mu_{B0} N_A \langle \mu \rangle / B_0$.

At high field strengths with slowly rotating molecules the Curie spin relaxation mechanism may become important, but it is generally negligible at the low fields used in MRI (typically up to 1.5 T, about 60 MHz proton Larmor frequency).¹¹⁷

3.5 Lanthanide-based nanoparticles as MRI contrast agents

25 The use of nanomaterials and nanoparticles as contrast agents has attracted much attention in the last few years, and this subject has been quite extensively covered by recent reviews.^{111,122–124} Examples of lanthanide-based nanosystems include surface-coated lanthanide oxide nanoparticles^{125,126} such as Gd₂O₃ (also doped to add luminescent or fluorescent upconverting properties⁴³), where the coating is typically glucuronic acid,⁷ lactobionic acid,¹²⁷ polyethylene glycol (PEG)^{128,129} to ensure biocompatibility and avoid precipitation. Ultrasmall Gd₂O₃ nanoparticles with particle diameters of about 1 nm exhibit a large R_1 relaxivity with a maximum between 1 and 2.5 nm diameter.

35 Along the same line, dextran coated paramagnetic gadolinium phosphate (GdPO₄) nanoparticles have been proposed for MRI tumor imaging, relying on their tens of nanometre size for accumulation into tumor cells, and on the dextran coating to prevent the rapid elimination from the blood stream.¹³⁰

Layered gadolinium hydroxychloride nanoparticles [Gd₂(OH)₅(H₂O)_x]Cl have also been proposed as MRI contrast agents: interestingly, such systems can be dispersed to form a stable colloidal nanosheet in aqueous medium.¹²⁵

45 Gadolinium fluorides (*i.e.* GdF₃ and NaGdF₄) have also attracted growing interest due to their chemical versatility and high relaxivity values.¹³¹ With respect to other inorganic NPs, these systems have the ability to quickly and reversibly exchange their cations by surface exposure to another lanthanide ion: indeed, this peculiar feature opens up the way to a straightforward synthesis of multimodal imaging NPs bearing, for instance, an up-conversion core and a paramagnetic shell.¹³² A study reported by van Veggel and co-workers¹³³ showed that the rate of increase in ionic relaxivity with decreasing NP size closely parallels the rate of increase in the NP surface-to-volume ratio, thus giving indication that the surface

Gd ions are the major contributors to the relaxivity enhancement. Furthermore, the surface Gd ions on a larger NP have been shown to affect the relaxivity more strongly than those on a smaller NP, which is consistent with the theory of inner-sphere relaxation.

Botta and co-workers¹¹⁵ have provided a thorough investigation into the structure and dynamics of the hydration shells of citrate-coated GdF₃ nanoparticles (Fig. 15). In this study, different citrate: Gd(III) molar ratios were used to investigate the effect of the organic shell on the relaxometric properties. The resulting NPs were thus investigated by nuclear magnetic relaxation dispersion, with the aim of understanding the operating PRE mechanisms and assessing their relative contributions. The longitudinal relaxivity ($1/T_1$) for these NPs is found to be significantly lower than the typical values of Gd-chelates conjugated to macromolecules or incorporated into nanosized systems (micelles, liposomes, silica NPs). The rationale behind this evidence lies in the fact that, in “chelated” macromolecular systems, all paramagnetic ions are accessible to the solvent and contribute to the relaxivity enhancement, mainly because of the reduced molecular tumbling. By means of NMRD measurements complemented with variable-temperature ¹⁷O experiments the same authors conclude that, for GdF₃ nanoparticles, Gd³⁺ surface ions are coordinated to citrate anions and to two inner-sphere water molecules which extensively contribute to R_{1p} . The second-sphere mechanism is also important in this case, and corresponds to the presence of four water molecules per metal ion on the surface, whereas the outer-sphere contribution is found to be negligible.

Another interesting system for the investigation of the PRE induced by lanthanide NPs is represented by the core@shell Gd³⁺-doped upconverting nanoparticles (UCNP) proposed by Bu and Shi and co-workers.¹³⁴ In the case of silica-shielded NPs (Fig. 17), the

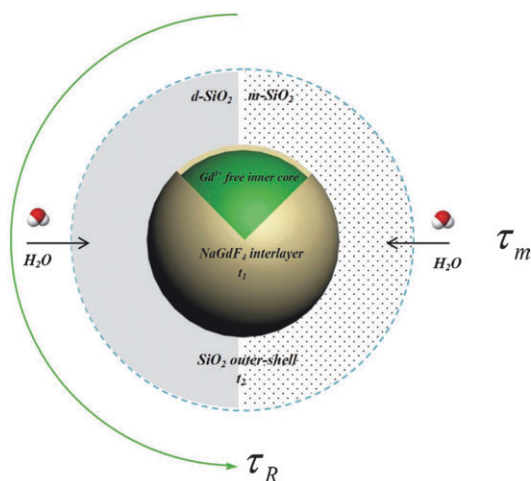

Fig. 17 Sketch of a silica protected, water soluble core@NaGdF₄ nanoparticle. The interlayer NaGdF₄ is the PRE active layer (t_1 = thickness), which contains thousands of surface Gd³⁺ ions as payload. Shell of tunable thickness (t_2) dense (d-) and mesoporous (m-) silica covers the single particle to create difference in porosity and particle size, which could potentially alter the coordinated number of water molecules. Adapted from ref. 134 Copyright 2013 Wiley-VCH Verlag GmbH & Co. KGaA, Weinheim.

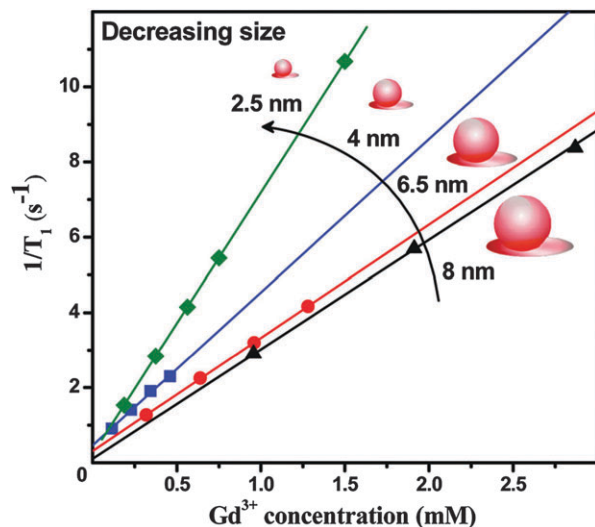

Fig. 18 Longitudinal relaxivity ($1/T_1$) of water protons per Gd(III) ion for NaGdF₄ NPs of different sizes in water (1.5 T). Surface-to-volume ratio $S/V = 3/r$ with r the radius of the nanoparticle. Adapted from ref. 133 Copyright 2011 American Chemical Society.

inner-sphere mechanism is hampered by the slow diffusion of water through the silica shell, and the longitudinal relaxivity enhancement of water protons occurs mainly *via* the outer-sphere mechanism. It is worth remarking that, in macromolecular systems with chelate paramagnetic ions, the efficiency of PRE can be controlled by varying the size of the macromolecule (that is, τ_c) or the chemistry of the chelating groups (and hence τ_M). In lanthanide-based nanosystems, the lanthanide ions on the surface are the major contributors to the PRE of water protons, while the core ions do not provide a significant contribution to the relaxivity.¹³⁵ PRE in these systems is thus driven by the surface-to-volume ratio (S/V , see Fig. 33) and by a careful choice of the coating layer, which can possibly endow secondary sphere relaxation and control the water access to the NP surface.

However, the rotational correlation time τ_c increases with the NP size, contrasting the S/V effect and making the surface ions on larger NPs much more relaxation-efficient than those on smaller NPs. Clearly, the complex balance among all these effects is best assessed through the experimental evidence, as testified by the great amount of synthesis and characterization efforts that has been recently invested in these nanoproboscopes (Fig. 18).

Gadolinium-based NPs doped with fluorescent lanthanide elements have also attracted attention for their ability to act as MRI and fluorescence imaging agents. In principle, the combination of fluorescent bioimaging with MRI capabilities is appealing because the greater sensitivity and resolution of fluorescence imaging may complement MRI data. Examples of such systems include PEGylated Gd₂O₃:Tb³⁺ NPs¹³⁶ and mixed Eu_{0.2}Gd_{0.8}PO₄·H₂O NPs.¹³⁷ GdF₃ NPs doped with Er³⁺/Yb³⁺ and Tm³⁺/Yb³⁺ have also been proposed as bimodal probes for both *in vitro* and *in vivo* optical and MRI, the latter technique taking advantage from the high R_2 relaxivity found

1 for these hybrid NPs.¹³⁸ Unfortunately, one of the general
 limitations of Gd-doped magnetic/upconversion fluorescent
 probes is their relatively low longitudinal relaxivity R_1 , which
 can prevent their use in living systems. For the same UCNPs, a
 5 number of reports have shown that a fluorescence enhance-
 ment of lanthanide ions in the lattice can be obtained by
 introducing a coating layer that shields the surface emission
 ions and reduces the surface defects. As an example, a NaYF₄
 matrix can shield Er³⁺ ions from the surroundings and enhance
 10 their fluorescent intensity as compared to those at the crystal
 surface, but the same matrix also isolates Gd³⁺ ions from the
 water molecules, thus reducing R_1 . In practice, for such nanop-
 robes, deep (>4 nm) Gd³⁺ ions do not contribute significantly
 to the longitudinal relaxivity. These observations have inspired
 15 the synthesis of a highly efficient nanosystem for bimodal T_1
 MRI and upconversion fluorescent imaging.¹³⁹ In such a way,
 Gd-doped UCNPs were designed with a thin NaGdF₄ layer
 deposited on Gd-free NaYF₄:Er/Yb cores, achieving a R_1 value
 of 6.18 mM⁻¹ s⁻¹.

20 Gadolinium oxysulfide NPs doped with other lanthanides
 (Eu³⁺, Er³⁺, Yb³⁺) have been suggested as multimodal platforms
 for MRI, X-ray and photoluminescence imaging.¹⁴⁰ Gd₂O₂-
 S:Eu³⁺ NPs show a strong transverse relaxivity and a strong
 X-ray absorption, allowing their use as contrast agents for
 25 T_2 -weighted MRI and X-ray tomography. Similarly, upconvert-
 ing Gd₂O₂S:Er; Yb NPs can be used both for *in vivo* deep
 fluorescence imaging and for MRI. Core-shell nanoparticles
 with NaLuF₄:Yb³⁺,Tm³⁺ as the core and SiO₂ as the shell layer,
 complemented with the complex Gd-DTPA as the surface
 30 ligand, have also been designed for trimodal NIR-to-NIR upcon-
 version, MRI and X-ray tomography imaging.¹⁴¹

Bio-functionalized NPs with a core-shell structure have also
 been prepared for MRI and fluorescence imaging. These sys-
 tems feature a Prussian blue core containing interstitial gado-
 35 linium and a biofunctional shell of fluorescent avidin and
 biotinylated antibodies that enable molecular targeting of
 eosinophilic cells.¹⁴²

3.6 Comparison with other MRI contrast agents based on 40 Gd(III) complexes

Among the many parameters appearing in the equations
 related to PRE, only a few are actually in control of the synthetic
 chemist, namely τ_M (related to the exchange and to the chem-
 45 istry of the chelating molecules) and τ_c (related to the size of the
 whole complex). As shown in the previous paragraphs, a
 decrease in the correlation time of a lanthanide complex can
 lead to a significant improvement in the relaxivity, and much
 effort has been devoted to the conjugation of Gd(III) complexes
 with macromolecules or nanoscopic objects *via* bifunctional
 50 linkers. Nonetheless, while the optimal condition of fast
 exchange $\tau_M \ll T_{1M}$ is easily met for small complexes, the
 situation changes significantly for macromolecular conjugates,
 where the fast exchange condition is much more stringent and
 requires τ_M to be in the order of tens of nanoseconds.¹¹¹ This
 55 regime is hardly met by lanthanide-DOTA or lanthanide-DTPA
 macromolecular conjugates, for which an intermediate- or

slow-exchange regime typically applies ($\tau_M \geq T_{1M}$). Indeed,
 proper chemical tuning may recover the fast exchange regime,
 but the requirement of clinically approved complexes of excep-
 5 tional stability severely limits the design of new ligands for
in vivo applications.

Amplification of an otherwise modest ionic relaxivity can be
 achieved through scaffolds that accommodate a large number
 of paramagnetic complexes on a single macromolecule. In this
 context dendrimers, monolayer-protected nanoparticles and
 virus capsids have provided perhaps the best results in terms
 10 of relaxivity gains (see Table 2). Liposomes have also been
 prepared by the self-assembly of amphiphilic units bearing
 chelate Gd ions. Albeit of limited “per unit” efficiency, the
 appeal of liposomes for *in vivo* imaging mainly stems from their
 high biocompatibility and easy manipulation of their physico-
 15 chemical properties. Furthermore, in the wide list of nano-
 scopic MRI contrast agents, a distinctive role is played by super
 paramagnetic iron oxide nanoparticles (SPIOs), whose clinical
 use (*e.g.* Combidex) relies on their ability to strongly enhance
 20 T_2 -weighted images, particularly in liver, spleen, and bone
 marrow.

As compared to other macromolecular contrast agents, it
 can be seen from Table 2 that lanthanide-based nanoparticles
 have a relatively low per unit relaxivity, which is partly recov-
 25 ered by increasing the number of paramagnetic centres loaded.
 Indeed, the capability to act as multimodal imaging agents still
 represents an unmatched and most attracting characteristic of
 this class of compounds.

Despite the established use of lanthanide-based drugs in
 clinical MRI, the biotoxicity of their nanoscopic analogues is
 not extensively studied and still little understood.¹⁴³ In general,
 macromolecular conjugates tend to have a much longer dwell
 time in the body and a more difficult elimination, their toxicity
 varies with the type, size and surface functional groups. SPIO
 35 nanoparticles, the only class of NPs clinically used as MRI
 contrast agents, seem to have a high *in vitro* toxicity, which can
 be however attenuated by proper coating (namely with dextran).
 Observed toxic effects range from cell death to inflammatory
 reactions, and from particle agglomeration to alterations in
 neurobehavior. Most of the nanoparticles listed in Table 2 show
 40 prolonged tissue retention and contain heavy metals, some-
 thing that is highly concerning from a clinical perspective. The
 long-term *in vivo* toxicity is generally evaluated in rats or mice
 by weight measurement, behaviour observation, histology and
 haematology analysis: yet, the toxicity evaluation protocols still
 45 lack uniformity as far as the physicochemical properties and
 the nanomaterials’ applications are concerned.⁵⁵

4. Multi-modal NPs for other imaging 50 techniques

Lanthanide-based NPs can be conveniently used also for ima-
 55 ging techniques other than MRI and OI, like CT, PET, and
 SPECT. In the majority of cases, however, this occurs when
 dual- or tri-modal nanoprobe are designed, typically

Table 2 Relaxivities of main clinical gadolinium agents, and of various paramagnetically-labeled molecules, polymers, and colloidal systems

Contrast agent	Type	M_w (kDa) or diameter	Per unit (molecule) total (nm-system) r_1 ($\text{mM}^{-1} \text{s}^{-1}$)	Per unit r_2 ^1H ($\text{mM}^{-1} \text{s}^{-1}$)	Temp. ($^{\circ}\text{C}$)	pH	Notes	Ref.
Gd(DTPA) – Magnevist	Molecule	0.546	4.3	—	25	—	Gadopentetate dimeglumine DTPA =	151 and 152
Gd(DOTA) – Dotarem	Molecule	0.559	3.56	4.75	39	—	diethylenetriaminopentacetate	152–155
Gd(HP- DO_3A) – ProHance	Molecule	0.559 (0.588)	3.7	—	40	—	DOTA = gadoteric acid	153, 156 and 157
Gd- DO_3A - P^{ABn}	Molecule	0.666	4.2	—	37	7.5	Gadoteridol	158
Heterobimetallic Re(I)–Gd(III) complex	Bimodal (MRI/FOI) molecular probe	1.02	8.6 (water)	—	—	—	Monophosphinated analogue of DOTA	159
[[Gd(DTPA)-phen] $_3$] $(\text{H}_2\text{O})_3$ Ru] complex	Bimodal (MRI/FOI) molecular probe	2.50	3.9 (PBS)	20	37	7.4	ph-phen = 1,10-phenanthroline	160
Gd(III)-DTPA-bismonomethylamide	Probe for peroxidase (HRP) imaging	0.79	4.3 (PBS)	—	40	7.4	No significant interaction with HSA was detected	161 and 162
1,4-AQ-Gd $_2$	Bimodal (MRI/FOI) molecular probe	1.32	15.9 (PBS, HRP)	—	37	—	Gd(III)-DTPA-bisamides that oligomerize in the presence of peroxidase- H_2O_2 pair	163
Eu(III)Gd(III) $_3$ Trispicolinamide complex	Bimodal (MRI/FOI) molecular probe	2.78	5.4 (11.7 DNA bound)	—	37	—	Anthraquinone-Gd(III) $_2$ -dimetallic complexes, binding to DNA	164
Gd-DOTA-k(fluorescein)-Gal-CPP	Bimodal (MRI/FOI) molecular probe	2.69	28.8	—	37	7.4	Eu(III), Gd(III) heteropolymetallic lanthanide complex	165
Polysiloxane-GdDTPA	Polymer	48.7	16.8	—	21	—	Dual-labeled probe for intracellular MRI/FOI of β -galactosidase enzyme	166
Gd(III) and Eu(III) chelating acrylate star polymers	Star polymer	10 \pm 2 nm	13.1 (850 polymer)	—	39	—	Cellular uptake monitored by FOI.	167
G4-(Gd- DO_3A - $\text{P}^{\text{BnN1,31}}$) $_{59}$	PAMAM dendrimer	—	84	—	37	—	MRI <i>in vivo</i> experiments	158
G5-(GdEPTPA) $_{111}$	PAMAM dendrimer	—	18.6 (1097 dendrimer)	—	37	7.5	Reversible T and pH dependency	168
G7-(GdEPTPA) $_{253}$	PAMAM dendrimer	—	17.1 (~1900 dendrimer)	—	37	7.4	—	169
G9-(GdEPTPA) $_{1157}$	PAMAM dendrimer	—	25.6 (~6500 dendrimer)	—	37	—	—	170
MS2-HOPO- R_2R	Virus capsids	~14.5 (capsid + linkers)	27.9 (~32 900 dendrimer)	—	60	37	—	171
Gd-DTTA-Au NPs	Gold NPs	27 nm (DLS)	38.2 (6876 capsid)	—	60	7.0	A rigid linker between the Gd-contrast agents and the viral capsid increases relaxivity properties	172
Au@Gd-DOTA-SiO $_2$	Silica coated Au NPs	4.8 nm	60 (3000 particle)	—	30	25	Diamagnetic yttrium ions functionalization is also reported	173
DOTA-monopropionamide C18 (L $_n$)	Micelle/liposomes	9 nm	810	3000	r.t.	—	Au NPs coated with a Gd-DOTA doped silica shell	174
Gd-DOTAGAC $_{12}$	Micelle/liposomes	15–18 nm	13 500	15 800	—	—	—	175
Gd-DOTA(GAC) $_{12}$	Micelle/liposomes	—	24.2	—	25	—	—	176
Gd(III)-ND	Gd(III)-nanodiamond conjugate	55–130 nm	15.4 (mol in micelles); 17.0 (mol in liposomes)	—	60	37	—	177
AMI-227	SPIO, dextran coated	20–40 nm	38.8 (mol in micelles); 40.0 (mol in liposomes)	—	20	37	—	178
Iron oxide@SiO $_2$	SPIO NPs coated with mesoporous silica	9–10 nm (SPIO core) 40–66 nm (overall)	58.8 (particle)	65 (particle)	60	5–7.4	Sinerem or Combix Human blood pool half-life of more than 24 h	179

Table 2 (continued)

Contrast agent	Type	M _w (kDa) or diameter	Per unit (molecule) total (nm-system) r ₁ (mM ⁻¹ s ⁻¹)	Per unit r ₂ (mM ⁻¹ s ⁻¹)	¹ H freq. (MHz)	Temp. (°C)	pH	Notes	Ref.
Gd(III)-DO ₃ A-TiO ₂	TiO ₂ NPs	3–5 nm	3.5 (61.0 particle)	—	60	37	—	NPs were studied over time in biological suspensions, acetate buffer (pH 5) and PBS (pH 7.4)	179
Gd-DTTA-Rubpy-SiO ₂ NPs	Luminescent and para-	37 nm	2.0 × 10 ⁵ (particle)	6.1 × 10 ⁵	128	—	—	DNA labeled nanoparticles	180
Gd-DTPA-Rubpy-SiO ₂ NPs	magnetic hybrid silica NPs	40 nm	4.9 × 10 ⁵ (particle)	7.8 × 10 ⁵	—	—	—	Hybrid silica NPs containing a Ru(bpy) ₃ ²⁺ core and a paramagnetic coating of a silylated Gd(III) complex	171
Gd-DOTA SiO ₂ -coated QDs	Silica coated QDs	8 nm	1019	2438	60	37	—	CdSe/ZnS QDs coated with Gd(III)-DOTA doped silica. 20 to 320 Gd(III) ions per QD	181
Mn ₃ O ₄ @SiO ₂ (RBTC)-FA core-shell	Silica-coated manganese oxide NPs	35 nm	0.50 0.47	—	20 128	37	7.4	Silica-coated Mn ₃ O ₄ NPs conjugated with rhodamine B and folate (FA). <i>In vitro</i> MRI on HeLa and MCF-7 cells	182
Gd-DOTAMA@MCM41	Mesoporous silica	20–50 nm	27 ± 2 (9700 particle)	—	20	37	—	Relaxometric properties are constant over a large pH range, and strongly depend on the pore size and Gd-complex localization	183
Gd-DOTAMA@SBA-15	Mesoporous silica	600–700 nm	6.7 ± 0.3 (2 × 10 ⁸ particle)	—	20	37	—	Mesoporous silica NPs containing redox cleavable Gd(III) chelates, PEG and anisamide ligand to improve biocompatibility and targeting specificity.	184
Gd-DOTAGA-MCM41	Mesoporous silica	20–50 nm	37.8 (29 500 particle)	—	20	37	—	Core-shell structured lanthanide-based NPs, NaLu-	141
Gd-MSNs	Mesoporous silica	3000 nm	19.0	46.8	128	37	7.4	F ₄ YD ³⁺ , Tm ³⁺ @SiO ₂ -GdDTPA for NIR-to-NIR UCL, CT and MR	125
PEG-Gd-MSNs	Mesoporous silica	145 nm	25.7	56.0	—	—	—	<i>In vivo</i> imaging	126
AA-Gd-MSNs	Mesoporous silica	160 nm	—	—	—	—	—	Maximal r ₁ for d in the 1–2.5 nm range	127
UCNP@SiO ₂ -GdDTPA	Silica coated UCNPs	30 nm	6.35	—	20	—	—	<i>In vivo</i> imaging (3 T) of rats with brain tumors (Gd ₂ O ₃ @-glucuronic acid)	185
Gd ₂ O ₃ NPs	Ultrasmall gadolinium oxide NPs	~1 nm	9.9	10.5	64	—	—	Multimodal imaging: SPECT/MR/optical. NPs cleared by renal excretion without accumulation in liver and RES uptake	136
Gd ₂ O ₃ @D-glucuronic acid	Ultra small gadolinium oxide NPs	0.9 nm	12.611.6	12.9	64	—	—	Gd ₂ O ₃ NPs doped with terbium ions synthesized by a polyol route with fluorescent and magnetic contrast agent properties	186
Gd ₂ O ₃	Gd ₂ O ₃ NPs with a polysiloxane shell doped with Cy5 and indium-111 radionuclide	3–4 nm	—	—	300	37	<i>In vivo</i>	NPs coated by poly(acrylic acid)	187
Gd ₂ O ₃	Ultrasmall Gd ₂ O ₃ NPs	4.3 ± 1 nm	PEG-silane 12.0 ± 0.5 Mal-PEG-NHS 14.2 ± 0.5 SH-PEG-NH2 7.8 ± 0.9	—	64	21–23	Water	Antibody labelled NaGdF ₄ nanocrystals, coated by PEG, detecting intraperitoneal tumor xenografts in nude mice by MRI	187
GHC-1 (Gd(OH)CO ₃ ·2H ₂ O)	Ultrasmall Gd hydrated carbonate	2.3 ± 0.1 nm	23.4	46.4	128	25	—		
NaGdF ₄	Gadolinium fluoride nanocrystals	16.9 ± 1.7 nm (DLS) 19.8 ± 1.0 nm 51 nm (DLS)	34.8 8.78	40.6	23 200	32	—		

Table 2 (continued)

Contrast agent	Type	M_w (kDa) or diameter	Per unit (molecule) total (nm-system) r_1 ($\text{mM}^{-1} \text{s}^{-1}$)	Per unit r_2 ($\text{mM}^{-1} \text{s}^{-1}$)	^1H freq. (MHz)	Temp. ($^{\circ}\text{C}$)	pH	Notes	Ref.
GdF_3	Citrate-capped GdF_3 NPs	2.2–2.3 nm	3.9 (330 particle) 5.3 (448 particle)	5.36.4 7.1	2040 60	37	—	r_1 (20 MHz, 298 K) constant over a 115 period of at least 72 h in a biological relevant media (Seronorm TM)	115
NaGdF_4	β - NaGdF_4 NPs	2.5–8.0 nm	5.6 (471 particle) 3.0–7.2	—	64	—	—	Relaxivity per NP is 200–3000 times larger than the clinical agent. Ionic relaxivity is larger for 2.5 nm NPs	133
$\text{NaYF}_4:\text{Yb},\text{Tm}-\text{NaGdF}_4$	NaYF_4 - NaGdF_4 core-shell NPs	20 \pm 1 nm	2.33 (1.56×10^4 particle)	160	400	—	—	UC properties ex. 980/em. 800 nm	132
GdPO_4	Dextran coated GdPO_4 NPs	23 \pm 8 nm	13.9	15.0	64	40	7.4	<i>In vivo</i> imaging of the femoral region of VX2 tumor-bearing rabbit	130
$\text{Eu}_{0.2}\text{Gd}_{0.8}\text{PO}_4$	$\text{Eu}_{0.2}\text{Gd}_{0.8}\text{PO}_4 \cdot \text{H}_2\text{O}$ NPs	40 \pm 4 nm 71 \pm 14 nm	6.13 (47 000 particle) 2.56 (82 000 particle)	7.79	60	37	—	<i>In vitro</i> (HeLa cells) and <i>in vivo</i> (C. elegans) experiments. FOI and MRI agents.	137
$\text{NaYF}_4:\text{Er}/\text{Yb}@/\text{NaGdF}_4$	Core@ NaGdF_4 UCNPs	145 \pm 36 nm Core 23.8 nm Core@ NaGdF_4 24 nm Core@ NaGdF_4 24.5 nm Core@ NaGdF_4 25.8 nm Core@ NaGdF_4 27.5 nm	2.34 (164 000 particle) — 6.18 6.14 5.46 2.18	—	128	—	—	<i>In vitro</i> Shell thickness-dependence of negative lattice shielding effect in Gd-doped UCNPs. Longitudinal relaxivities (r_1 per Gd ion) of silica protected water soluble Core@ NaGdF_4	135
$\text{NaLuF}_4:\text{Yb}^{3+},\text{Tm}^{3+}@/\text{SiO}_2-\text{GdDTPA}$	UCNP@ SiO_2 -GdDTPA	Core 30 nm Core@ SiO_2 40 nm	6.35	—	128	—	Water <i>In vivo</i>	Multifunctional lanthanide-based NPs for NIR-to-NIR UCL, CT and MR <i>in vivo</i> imaging.	141
$\text{K}_{0.53}\text{Gd}_{0.89}\text{Fe}^{\text{III}}_4-[\text{Fe}^{\text{II}}(\text{CN})_6]_{3.8}$	Gd-NPs containing prussian blue	Core: 33 \pm 7 nm Core: 120 \pm 40 nm (DLS)	38.5 \pm 4.6	44.7 \pm 6.3	128	20	Water <i>In vitro</i>	Core-shell biofunctionalized NPs as multimodal imaging agents.	142

1

5

10

15

20

25

30

35

40

45

50

55

1 combining UPCNs for OI with one of the other imaging
 2 techniques. To our opinion, it is important to remind at this
 3 point that, as already discussed, the preparation of multimodal
 4 probes can help us to overcome some of the limitations
 5 characteristic of a single modality; it is however often under-
 6 estimated the problem associated with the different sensitivity
 7 offered by the various imaging techniques, which could hamper
 8 the use of the same probe under the same conditions (*e.g.*
 9 concentration) with two different modalities.

4.1 Nuclear medical imaging

10
 11
 12
 13
 14
 15 As already mentioned, from one hand both PET and SPECT,
 16 being based on radioisotopes, can benefit from a very high
 17 sensitivity and unlimited tissue penetration; on the other hand,
 18 the same decay causes health concern, disposal related pro-
 19 blems, and possible limitations to synthetic strategies. This last
 20 problem is particularly important in nanomedicine: the probe,
 21 in fact, has to be prepared and purified in a time shorter, or at
 22 least comparable, to the half-life of the nuclide. This severely
 23 limits the number of possible solutions, especially when,
 24 instead of rather simple molecules as ^{18}F FDG, a multicompo-
 25 nent nanostructure has to be prepared. For example, the most
 26 used radionuclide for clinical PET is ^{18}F , which has a half-life
 27 time of *circa* 110 minutes: a very rapid conjugation of ^{18}F
 28 into the NPs and a very high reaction yield are thus required in
 29 this case. To date, the only efficient strategy for the preparation
 30 of rare earth NPs for PET imaging has been proposed by the group
 31 of F. Y. Li and is based on the strong binding between fluoride
 32 anions and rare-earth cations.^{144–146} In particular, a water
 33 solution containing ^{18}F is typically added to a water dispersion
 34 of NPs; after a rather short (1–10 minutes) incubation, the NPs
 35 are purified by centrifugation. Since this strategy is simple and
 36 general, it has been used with NPs with different cores (such as
 37 Y_2O_3 , NaYF_4 , $\text{Y}(\text{OH})_3$, $\text{Gd}(\text{OH})_3$, eventually co-doped for obtain-
 38 ing UC material) and capped with various agents (citrate,
 39 Pluronic F127 or oleic acid/ α -CD). In a first example, with this
 40 strategy Li and coworkers¹⁴⁵ synthesized ^{18}F -labeled hydrophilic
 41 citrate-capped $\text{NaY}_{0.2}\text{Gd}_{0.6}\text{Yb}_{0.18}\text{Er}_{0.02}\text{F}_4$ probes made for
 42 PET, MRI, and UCL imaging. In particular, using a small-
 43 animal micro-PET scanner, 15 min after injection on anesthe-
 44 tized mice an intense signal was detected almost exclusively in
 45 the liver and spleen (Fig. 19). This was in agreement with the
 46 magnetic resonance images obtained with the same set of NPs
 47 that, however, are characterized by a low contrast. No evidence
 48 of clearance from these organs was observed after two hours.

49 In another example by the same group,¹⁴⁶ $\text{NaYF}_4:\text{Yb},\text{Tm}$
 50 UCNPs, capped with PEG and having a 20 nm diameter, were
 51 derivatized with $^{18}\text{F}^-$, and applied for lymph node monitoring.
 52 An intense signal could be detected in the left sentinel lymph
 53 node even 3 min after subcutaneous injection of the NPs into
 54 the left paw of a nude mice; dynamic observation indicated in
 55 particular a dramatic increase of the signal between 0 and 30
 min after injection, followed by a plateau. It is interesting to
 note that probes with dimensions ranging from 20 to 100 nm
 are of great interest for sentinel lymph node mapping,¹⁴⁷ so

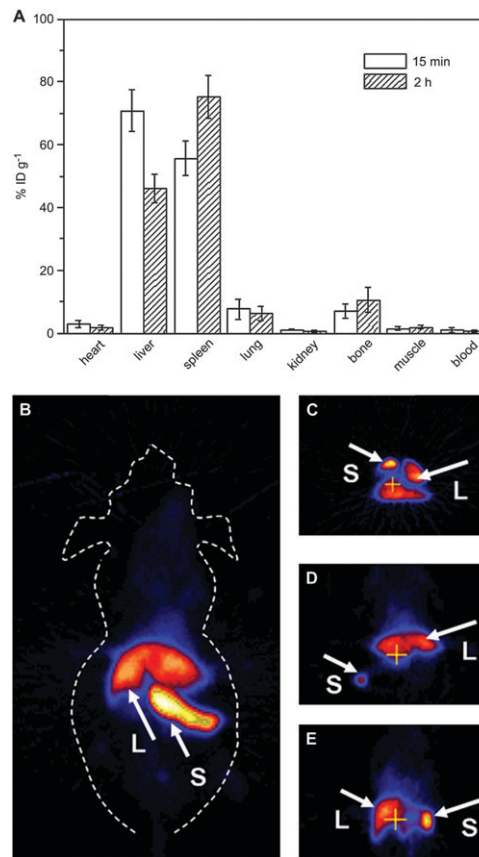

Fig. 19 (A) Biodistribution of ~ 148 kBq ^{18}F -labeled-cit-NPs at 15 min and 2 h post-injection ($n = 5$). *In vivo* micro-PET images acquired at 15 min after intravenous injection of ~ 5.9 MBq ^{18}F -cit-NPs. (B) Whole-body two-dimensional projection, (C) transversal, (D) coronal, and (E) sagittal images are shown respectively. The arrows inset point to the liver (L) and spleen (S). Adapted from ref. 145 Copyright 2011 Elsevier Ltd.

that the use of NPs is particularly promising for this crucial application.

The luminescence properties of these NPs (two distinct bands at 475 and 800 nm upon 980 nm CW excitation) were conveniently used to verify their distributions within organs *in vivo*. Analogous results were also obtained *in vivo*, after improving the water solubility of OA capped lanthanide-doped nanocrystals *via* supramolecular alkyl chain/ α -cyclodextrin (α -CD) host-guest association. This approach resulted independent from the nanocrystal size, shape and core composition, and was applied by Li and co-workers to $\text{NaYF}_4:20\text{mol}\%\text{Yb},2\text{mol}\%\text{Er}$ NPs obtained by thermal decomposition. The final multimodal system was suitable for cell labelling *in vivo*.¹⁴⁴ These results clearly indicate that the formation of a supramolecular adduct with α -CD can be widely applied in improving the water-solubility of UCNPs. The same strategy has also been used for preparing tri-modal (NMR, UCL, and PET) NPs by Li and coworkers, in this case as the final step of the synthetic procedure.¹⁴⁸ They started from $\text{NaYF}_4:\text{Yb},\text{Er}$ oleate capped nanoparticles obtained by solvothermal synthesis, to develop multifunctional up-conversion nanoparticles ($\text{NaYF}_4:\text{Yb},\text{Er}$), combining magnetic (Gd^{3+}), PET (^{18}F), and

targeted recognition (folic acid) properties. In particular Gd^{3+} was introduced on the surface of the nanocrystals by cation exchange with Y^{3+} ions, while ^{18}F was introduced for PET imaging by interaction with the rare-earth ions.

In particular, surface Gd^{3+} ions obtained in this way have the advantage to present strong T_1 enhancement as already discussed. The incubation with $^{18}F^-$ anions followed the surface coverage with OA, aminocaproic acid and folic acid, used to confer water solubility and target ability toward cancer cells. The approach described so far has however two important limitations. The first one is intrinsic to the chosen radionuclide: the short half-life of ^{18}F does not allow investigations for a time longer than *circa* 2 h.

Moreover, about 5% dissociation of ^{18}F from UCNPs was observed, with a potentially negative effect on the toxicity and on the imaging quality.¹⁴⁹ Theoretically, this last problem could be avoided – with one-step synthesis of the UCNPs – using $^{18}F^-$ as a reagent for the preparation of the NP core; unfortunately not a possible option since the synthesis would require more than 8 h being suitable only for radioisotopes showing a longer half-life. To address this issue ^{124}I , a radionuclide with a half-life of 4.18 days, has been used to derivatize the RGD peptide conjugated with 30 nm $NaGdF_4:Yb^{3+}/Er^{3+}$ UCNPs, preparing in this way a trimodal PET/MR/optical probe. These NPs showed – thanks to the targeting properties of the RGD peptide – a high specificity for $\alpha_v\beta_3$ integrin-expressing U87MG tumor cells and xenografted tumor models.¹⁵⁰ Within the lanthanide-based NPs, a more general possibility for inserting a radionuclide with sufficiently long half-life is represented by ^{153}Sm , which has a half-time of 46.3 h, thus offering the possibility to overcome the main limitations encountered by the use of ^{18}F . ^{153}Sm , emitting beta particles and gamma rays ($E_\gamma = 103$ keV), allows SPECT imaging.

Furthermore, $^{153}Sm^{3+}$ shows chemical properties, including the ionic radius, similar to the other lanthanide Ln^{3+} ions, and it can thus be easily used for doping Ln-based nanoparticles. In addition, because of the high sensitivity typical of the SPECT imaging, the low amount of $^{153}Sm^{3+}$ that is required does not alter substantially the properties of the host structure including, if any, its UC ability. An interesting example is represented by $NaLuF_4:^{153}Sm, Yb, Tm$ nanoparticles, obtained by hydrothermal synthesis by Y. Yang and coworkers.¹⁴⁹ These NPs, with a 25–30 nm diameter and capped with OA and 6-aminohexanoic acid, showed a UC luminescence higher than that observed with $NaYF_4$ -based NPs; for this reason they could be used for the first time in the imaging of normal Kunming mice with rich fur *in vivo*. Using the same NPs, SPECT images were taken at 1 and 24 h after injection. Also in this case, as it can be seen from Fig. 20, an intense signal was observed in the liver and in the spleen, in agreement with UCL images. At 24 h, the authors observed a much larger uptake by the spleen compared to the liver, a result that can be partially explained by the fact that spleen is the largest organ of the immune system.

A different, and easier approach for the synthesis of SPECT active NPs has been successively proposed by the same group, based on a post-labelling procedure through a cation exchange

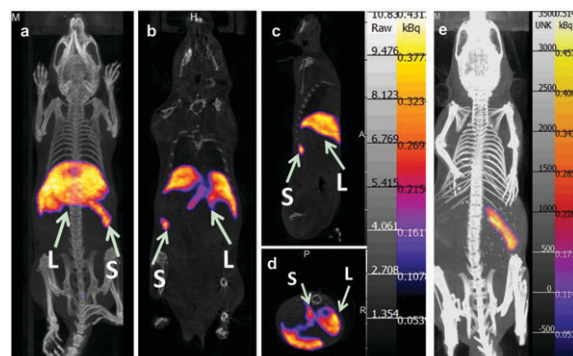

Fig. 20 *In vivo* SPECT images after intravenous injection of Sm-UCNPs. (a) Whole-body three-dimensional projection, (b) coronal, (c) sagittal and (d) transversal images acquired at 1 h and (e) whole-body three-dimensional projection images acquired at 24 h are shown respectively. The arrows inset point to the liver (L) and spleen (S). Adapted from ref. 149 Copyright 2011 Elsevier Ltd.

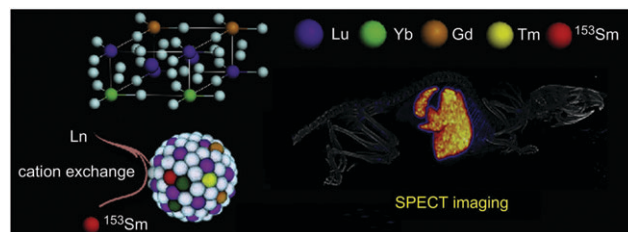

Fig. 21 Schematic representation of ^{153}Sm -postlabeled citrate-capped $NaLuF_4:Yb,Gd,Tm$ by cation exchange for *in vivo* quantitative tracking. Adapted from ref. 188 Copyright 2013 Elsevier Ltd.

method, as schematized in Fig. 21.¹⁸⁸ In this case, citrate-capped $NaLuF_4:Yb,Gd,Tm$ were mixed with $^{153}SmCl_3$ aqueous solutions; the precipitate obtained after a very short shaking (less than 1 min) at room temperature was collected by centrifugation.

Almost no dissociation of $^{153}Sm^{3+}$ from the nanoparticles was observed, even after storage in fetal bovine serum for 72 h. Moreover, when injected into mice, only a negligible $^{153}Sm^{3+}$ signal was observed in urine (by large, the main excretion route for the free ion) even at 300 min after injection, indicating a negligible dissociation also *in vivo*. The results obtained showed that this synthetic strategy could be used to prepare efficient dual-mode (UCL and SPECT) nanoparticles with a very short labelling time (less than 1 min). Interestingly this strategy could be extended to other series of rare-earth nanoparticles, including phosphates, fluorides, and oxides of rare-earth ions, offering in all cases high labelling yield and stability.

Taking advantage of the two described synthetic methods, slightly different materials were realized for a very interesting pre-clinical application: blood pool imaging *in vivo*. In a first case RE-based nanoprobe constituted by very small (sub-10 nm) PEG-coated UCNPs doped with $^{153}Sm^{3+}$ were prepared using a hydrothermal synthetic procedure.¹⁴⁹ The SPECT imaging clearly indicated that these NPs have a long blood retention time *in vivo* and, importantly, that the renal excretion was

1 in this case more rapid than the hepatobiliary excretion in the
 faeces. In a second example, larger (20 nm) radioactive/upconverting
 NaLuF₄:Yb,Tm, ¹⁵³Sm NPs, coated with ethylenediamine tetramethy-
 5 lenephosphonic acid (EDTMP), were synthesized *via* a solvothermal
 method, with the advantage of a reduced time consumption with
 respect to the previous example. However, as expected because of
 their larger size, a remarkable accumulation of these NPs in liver
 and in spleen could be observed at 1 h after injection.

10 4.2 X-ray CT

As already mentioned in the Introduction, also X-ray CT is a
 widely used imaging technique in medicine. In this case,
 together with barium salts, non-ionic, low-osmolar iodinated
 small molecules as iobitridol are used as contrast agents in
 15 clinical applications. These molecules, however, suffer from
 short circulation lifetime and renal toxicity.^{189,190} Y. Liu *et al.*¹⁸⁹
 demonstrated that NaYbF₄:Er NPs, when doped with Gd³⁺
 concentration of 20 mol% or higher (to obtain a better control
 over size and shape) and capped with a PEG derivative, could be
 20 very promising for this technique. As a matter of fact, these NPs
 showed a higher CT contrast signal under the normal operating
 conditions of clinical imagers (120 kVp) not only in comparison
 with a solution having the same concentration (g mL⁻¹) of
 iobitridol, but also with respect to salts of heavy metals (Au, Pt,
 25 Bi, and Ta). The K-edge of Yb (61 keV) is in fact located just
 within the higher energy region of the X-ray spectrum obtained
 with the usual clinical setting. It has to be very briefly recalled
 here that the binding energy of the K shell electrons in an atom
 (K-edge) has to be at least paired, or better a bit exceeded, by the
 30 energy of the photon to be absorbed. In contrast, the K-edge
 values of Au, Pt, Bi, and Ta were found to be far from the region
 of clinical imagers, thus revealing that Ln-based probes could be
 among the most effective *in vivo* CT contrast agents at 120 kVp.

A rare example of a dual probe for SPECT and X-ray CT
 35 imaging was based on hydrophilic PEG coated EuOF:¹⁵³Sm
 NPs.¹⁹¹ In this case, together with the imaging modality given
 by the presence of ¹⁵³Sm³⁺ as a dopant, the authors took profit
 of the high degree of X-ray absorption of europium. These NPs,
 having a diameter core of about 5 nm, showed indeed a significant
 40 (although lower than the one observed with Yb at the same
 concentration) CT contrast signal, as shown in Fig. 22 in
 Hounsfield units (HU).

This figure shows CT images acquired 20 min after the
 injection into the left paw of a mouse of 150 μL of the NPs at
 a concentration of 4.0 mg mL⁻¹. As can be seen, a significant
 contrast enhancement of the lymph node could be observed,
 extending in this way the applications of these NPs. SPECT
 45 images were conveniently taken with the same nanostructures
 for determining their dynamic distribution *in vivo*, indicating a
 blood lifetime of 4.65 h, and an efficient elimination through
 biliary/gastrointestinal pathway. As already mentioned, the
 ability to efficiently absorb X-rays is common to all the RE
 50 elements, and for this reason it has been used in other cases,
 for example with Gd₂O₃:Yb³⁺,Er³⁺ UC nanorods.¹⁹² In some
 cases, the presence of additional heavy atoms, such as Ba²⁺
 in the BaGdF₅:Yb/Er NPs, could even increase the CT contrast.¹⁹³

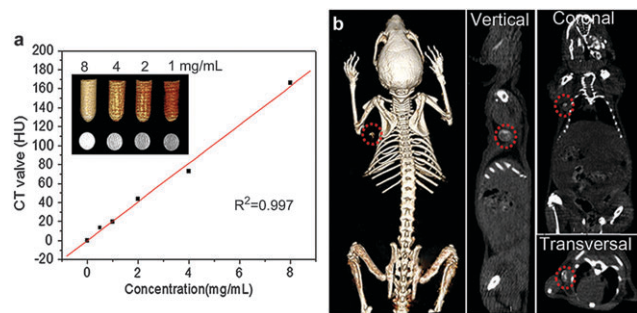

Fig. 22 (a) Hounsfield unit (HU) measurements of PEG-EuOF with different mass concentration of 1.0, 2.0, 4.0, and 8.0 mg mL⁻¹. Inset: phantom and color-mapped CT images of PEG-EuOF with different mass concentration. (b) *In vivo* CT volume-rendered and intensity of vertical, coronal, transversal images of 20 min after injection of 4.0 mg mL⁻¹ PEG-EuOF. The position of lymph node was marked by circles. Adapted from ref. 191 Copyright 2014 Elsevier Ltd.

20 4.3 Photoacoustic imaging

We would like to conclude this section with the example of a
 nanoprobe for photoacoustic imaging (PAI), a very interesting
 and promising imaging modality, with very significant advantages
 such as high resolution (10–100× *vs.* PET), deeper tissue
 penetration compared to OI, and cost-effectiveness compared to
 25 SPECT, PET, and MRI.^{194,195} In particular PAI requires a very
 efficient absorption in the NIR region; the instrumentation
 detects the ultrasound waves generated by the thermoelastic
 expansion of the medium surrounding the probe caused by the
 heat dissipation associated with the non-radiative deactivation
 30 processes of the excited state.

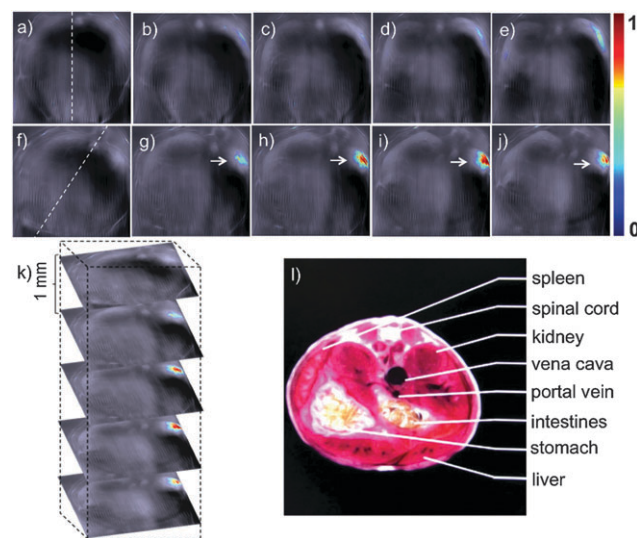

Fig. 23 Single-wavelength PAI of a live mouse anatomy at 980 nm. (a–e) Individual anatomy sections of the live mouse before intravenous injection of UC-α-CD. (f–j) Individual anatomy sections recorded after 35 min post-intravenous injection of UC-α-CD. Dashed lines in figure (a) and (f) indicate the positions of the mouse with respect to the viewer. Pointed areas in figure (g–j) indicate the localization of UC-α-CD. (k) Three-dimensional rendering of scanned area. (l) Schematic section corresponding to analyzed area. Adapted from ref. 196 Copyright 2014 Wiley-VCH Verlag GmbH & Co. KGaA, Weinheim.

To our knowledge, the only example reported so far is based on OA-stabilized hexagonal-phased $\text{NaYF}_4:\text{Yb}^{3+}, \text{Er}^{3+}$ (80:18:2) UCNPs dispersed in water.¹⁹⁶ Yu and co-workers solubilised these nanocrystals by α -CD addition exploiting supramolecular alkyl chain/ α -cyclodextrin (α -CD) host-guest association. The considerable luminescence quenching observed when dispersing the NPs in water (*circa* 62%) had the effect of enhancing the PA signal, although the possibility of performing UCL and PAI at the same time can be in general considered a precious advantage. PAI imaging *in vivo* of an anesthetized mouse showed a clear contrast enhancement localized on the kidney (Fig. 23), proving that these NPs could be used as efficient contrast agents for diagnostic purposes under 980 nm excitation.

5. Conclusions

In this review we have tried to guide the reader through the recent advancements in the research on lanthanide-doped NPs for bioimaging applications, a field where they display tremendous potential. The unique characteristics of these species have been discussed *via* many examples, reporting the different approaches used in the various imaging techniques for both *in vitro* and *in vivo* (small animals) experiments. Summarising the information reported in Tables 1 and 2 and discussed for the different systems, we here suggest a schematic outlook of the strengths and weaknesses of these nanoparticles as imaging agents, comparing them with their molecular counterparts.

The clinical translation of *optical imaging* is in its early infancy; in this scenario lanthanide based nanomaterials present a quite unique property: the possibility of obtaining upconversion luminescence. This is a precious way to shift the absorption toward the NIR region, the most suitable one for biomedical applications. On the other side, exploiting the more common down shifting luminescence processes takes to systems presenting both the absorption and emission in the NIR region, and this approach is more and more attracting the scientific efforts of the field. Nevertheless for a clinical translation, lanthanide-doped NPs, even presenting a high photostability, need further investigation to improve some still critical features. In particular the brightness of UCNPs that is generally quite low (due to parasite cross-relaxations and narrow and low extinction coefficients), possible batch-to-batch variability in emission efficiency, the surface functionalization or a multi-material core-shell design to obtain suitable retention times and efficient clearance when *in vivo*. A direct comparison with the performance of lanthanide complexes is difficult since their application is still quite far and rare also in living cells and their clinical translation is a very distant goal. This is due to many factors, among them the fact that many properties, especially in UCNPs, take profit of collective processes that are not possible in molecular structures. In addition, we would like to mention their blinking problems and the complexity of lanthanide photophysics that, being dramatically affected by the environment, often rises unpredicted problems in complex matrixes.

MRI contrast agents in the form of Gd-chelates represent an established clinical application of lanthanide based molecules. This topic has been given due prominence in the review, highlighting how it is possible to obtain a great boost in relaxivity through scaffolds that accommodate a large number of paramagnetic complexes on a single macromolecule of nanoscopic size. In this context dendrimers, monolayer-protected nanoparticles and virus capsids have provided perhaps the best results in terms of relaxivity gains. On the other side, when the gadolinium ions become part of a nanoparticle structure, the relaxivity gains are generally lower than the typical values of Gd-chelates conjugated to macromolecules. This evidence is mostly due to the physicochemical properties of lanthanide-doped nanoparticles and, together with other physiological factors such as the excretion times and the viscosity/osmolality of injectable preparations, it may represent a limitation to the practical use of these systems.

Another valuable characteristic of lanthanide-doped nanoplatforms is the possibility to obtain, with relatively versatile approaches, *multimodal imaging*. The examples discussed in this review clearly show the advantages of a multimodal approach that allows co-localization and multiple targeting at the same time. These valuable features are not possible at the molecular level and very difficult to obtain (usually with very tedious synthetic procedures) also following a supramolecular approach.

It has to be mentioned that lanthanide based NPs also allow a further degree of complexity and with a relatively facile design it is also possible to obtain systems for drug delivery and light activated therapies, in particular with high penetrating NIR radiation. This is opening up the way to the preparation of theranostic agents with remarkable qualities in terms of biocompatibility, low toxicity, targeting and stimuli-regulated drug release.

All together these NPs are expected to play a fundamental role in medical diagnosis and therapy in the future since they merge capabilities and advantages coming from different materials, strategies and from the knowhow of fields such as chemistry, physics, biology and medicine.

Acknowledgements

This work was supported by: MIUR (PON 01_01078 granted to L.P.); University of Bologna (FARB project A.10.N2.RICER.FARB2RODAA granted to LP, FARB project linea1. NANOX granted to NZ); Fondazione Cariverona (Verona, Italy, "Verona Nanomedicine" Initiative granted to A.S.); and Università degli Studi di Padova (PRAT CPDA132473/13, granted to F.R.).

Notes and references

- 1 F. Pene, E. Courtine, A. Cariou and J. P. Mira, *Crit. Care Med.*, 2009, **37**, S50.
- 2 Q. F. Xiao, X. P. Zheng, W. B. Bu, W. Q. Ge, S. J. Zhang, F. Chen, H. Y. Xing, Q. G. Ren, W. P. Fan, K. L. Zhao, Y. Q. Hua and J. L. Shi, *J. Am. Chem. Soc.*, 2013, **135**, 13041.
- 3 C. Y. Chen, Y. F. Li, Y. Qu, Z. F. Chai and Y. L. Zhao, *Chem. Soc. Rev.*, 2013, **42**, 8266.

- 1 4 R. Weissleder, M. Nahrendorf and M. J. Pittet, *Nat. Mater.*, 2014, **13**, 125.
- 5 T. Hussain and Q. T. Nguyen, *Adv. Drug Delivery Rev.*, 2014, **66**, 90.
- 5 6 S. Kaur, G. Venkaraman, M. Jain, S. Senapati, P. K. Garg and S. K. Batra, *Cancer Lett.*, 2012, **315**, 97.
- 7 V. Biju, *Chem. Soc. Rev.*, 2014, **43**, 744.
- 8 H. Gong, R. Peng and Z. Liu, *Adv. Drug Delivery Rev.*, 2013, **65**, 1951.
- 10 9 F. Novio, J. Simmchen, N. Vazquez-Mera, L. Amorin-Ferre and D. Ruiz-Molina, *Coord. Chem. Rev.*, 2013, **257**, 2839.
- 10 W. Arap, R. Pasqualini, M. Montalti, L. Petrizza, L. Prodi, E. Rampazzo, N. Zaccheroni and S. Marchio, *Curr. Med. Chem.*, 2013, **20**, 2195.
- 15 11 J. M. Warram, E. de Boer, A. G. Sorace, T. K. Chung, H. Kim, R. G. Pleijhuis, G. M. van Dam and E. L. Rosenthal, *Cancer Metastasis Rev.*, 2014, **33**, 809.
- 12 Y. Xing, J. Zhao, P. S. Conti and K. Chen, *Theranostics*, 2014, **4**, 290.
- 20 13 J. Gallo, N. J. Long and E. O. Aboagye, *Chem. Soc. Rev.*, 2013, **42**, 7816.
- 14 N. Lee, S. H. Choi and T. Hyeon, *Adv. Mater.*, 2013, **25**, 2641.
- 15 N. Mitchell, T. L. Kalber, M. S. Cooper, K. Sunassee, S. L. Chalker, K. P. Shaw, K. L. Ordidge, A. Badar, S. M. Janes, P. J. Blower, M. F. Lythgoe, H. C. Hailes and A. B. Tabor, *Biomaterials*, 2013, **34**, 1179.
- 25 16 F. Kiessling, S. Fokong, J. Bzyl, W. Lederle, M. Palmowski and T. Lammers, *Adv. Drug Delivery Rev.*, 2014, **72**, 15.
- 17 J. Unga and M. Hashida, *Adv. Drug Delivery Rev.*, 2014, **72**, 144.
- 30 18 S. Zackrisson, S. M. van de Ven and S. S. Gambhir, *Cancer Res.*, 2014, **74**, 979.
- 19 Q. Liu, W. Feng and F. Y. Li, *Coord. Chem. Rev.*, 2014, **273**, 100.
- 20 E. Hemmer, N. Venkatachalam, H. Hyodo, A. Hattori, Y. Ebina, H. Kishimoto and K. Soga, *Nanoscale*, 2013, **5**, 11339.
- 35 21 Z. Hou, Y. Zhang, K. Deng, Y. Chen, X. Li, X. Deng, Z. Cheng, H. Lian, C. Li and J. Lin, *ACS Nano*, 2015, **9**, 2584.
- 22 Y. Li, T.-y. Lin, Y. Luo, Q. Liu, W. Xiao, W. Guo, D. Lac, H. Zhang, C. Feng, S. Wachsmann-Hogiu, J. H. Walton, S. R. Cherry, D. J. Rowland, D. Kukis, C. Pan and K. S. Lam, *Nat. Commun.*, 2014, **5**.
- 40 **Q9** 23 R. Vankayala, Y. K. Huang, P. Kalluru, C. S. Chiang and K. C. Hwang, *Small*, 2014, **10**, 1612.
- 24 M. Guo, H. J. Mao, Y. L. Li, A. J. Zhu, H. He, H. Yang, Y. Y. Wang, X. Tian, C. C. Ge, Q. L. Peng, X. Y. Wang, X. L. Yang, X. Y. Chen, G. Liu and H. B. Chen, *Biomaterials*, 2014, **35**, 4656.
- 45 25 B. K. Wang, J. H. Wang, Q. Liu, H. Huang, M. Chen, K. Y. Li, C. Z. Li, X. F. Yu and P. K. Chu, *Biomaterials*, 2014, **35**, 1954.
- 50 26 G. Terentyuk, E. Panfilova, V. Khanadeev, D. Chumakov, E. Genina, A. Bashkatov, V. Tuchin, A. Bucharshkaya, G. Maslyakova, N. Khlebtsov and B. Khlebtsov, *Nano Res.*, 2014, **7**, 325.
- 55 27 H. H. Gorriss and O. S. Wolfbeis, *Angew. Chem., Int. Ed.*, 2013, **52**, 3584.
- 28 E. Rampazzo, S. Bonacchi, D. Genovese, R. Juris, M. Montalti, V. Paterlini, N. Zaccheroni, C. Dumas-Verdes, G. Clavier, R. Meallet-Renault and L. Prodi, *J. Phys. Chem. C*, 2014, **118**, 9261.
- 29 N. Khemthongcharoen, R. Jolivot, S. Rattanavarin and W. Piyawattanametha, *Adv. Drug Delivery Rev.*, 2014, **74**, 53.
- 30 R. R. Anderson and J. A. Parrish, *J. Invest. Dermatol.*, 1981, **77**, 13.
- 31 U. Rocha, K. U. Kumar, C. Jacinto, I. Villa, F. Sanz-Rodríguez, M. del Carmen Iglesias de la Cruz, A. Juarranz, E. Carrasco, F. C. J. M. van Veggel, E. Bovero, J. G. Solé and D. Jaque, *Small*, 2014, **10**, 1141.
- 32 R. Wang and F. Zhang, *J. Mater. Chem. B*, 2014, **2**, 2422.
- 33 D. Yang, P. a. Ma, Z. Hou, Z. Cheng, C. Li and J. Lin, *Chem. Soc. Rev.*, 2014, **44**, 1416.
- 15 34 L. Z. Zhao, J. J. Peng, Q. Huang, C. Y. Li, M. Chen, Y. Sun, Q. N. Lin, L. Y. Zhu and F. Y. Li, *Adv. Funct. Mater.*, 2014, **24**, 363.
- 35 M. V. DaCosta, S. Doughan, Y. Han and U. J. Krull, *Anal. Chim. Acta*, 2014, **832**, 1.
- 36 Y. Liu, D. Tu, H. Zhu and X. Chen, *Chem. Soc. Rev.*, 2013, **42**, 6924.
- 37 J. Zhou, Z. Liu and F. Li, *Chem. Soc. Rev.*, 2012, **41**, 1323.
- 38 C. F. Gainer and M. Romanowski, *J. Innovative Opt. Health Sci.*, 2014, **07**, 1330007.
- 39 A. Sedlmeier and H. H. Gorriss, *Chem. Soc. Rev.*, 2014, **44**, 1526.
- 25 40 M.-K. Tsang, G. Bai and J. Hao, *Chem. Soc. Rev.*, 2015, **44**, 1585.
- 41 W. Zheng, P. Huang, D. Tu, E. Ma, H. Zhu and X. Chen, *Chem. Soc. Rev.*, 2015, **44**, 1379.
- 42 S. L. Gai, C. X. Li, P. P. Yang and J. Lin, *Chem. Rev.*, 2014, **114**, 2343.
- 43 F. C. J. M. van Veggel, C. Dong, N. J. J. Johnson and J. Pichaandi, *Nanoscale*, 2012, **4**, 7309.
- 44 L. D. Sun, Y. F. Wang and C. H. Yan, *Acc. Chem. Res.*, 2014, **47**, 1001.
- 35 45 N. M. Idris, M. K. G. Jayakumar, A. Bansal and Y. Zhang, *Chem. Soc. Rev.*, 2014, **44**, 1449.
- 46 E. Pershagen and K. E. Borbas, *Coord. Chem. Rev.*, 2014, **273**, 30.
- 47 L. J. Xu, G. T. Xu and Z. N. Chen, *Coord. Chem. Rev.*, 2014, **273**, 47.
- 48 G. Liu, *Chem. Soc. Rev.*, 2015, **44**, 1635.
- 49 Y. Sun, W. Feng, P. Yang, C. Huang and F. Li, *Chem. Soc. Rev.*, 2015.
- 45 **Q10** 50 A. Gnach, T. Lipinski, A. Bednarkiewicz, J. Rybka and J. A. Capobianco, *Chem. Soc. Rev.*, 2015, **44**, 1561.
- 51 N. Bloembergen, *Phys. Rev. Lett.*, 1959, **2**, 84.
- 52 F. Auzel, *Chem. Rev.*, 2004, **104**, 139.
- 53 J. S. Chivian, W. E. Case and D. D. Eden, *Appl. Phys. Lett.*, 1979, **35**, 124.
- 50 54 M. F. Joubert, *Opt. Mater.*, 1999, **11**, 181.
- 55 Y. Zhang, W. Wei, G. K. Das and T. T. Y. Tan, *J. Photochem. Photobiol., C*, 2014, **20**, 71.
- 56 H. J. M. A. A. Zijlmans, J. Bonnet, J. Burton, K. Kardos, T. Vail, R. S. Niedbala and H. J. Tanke, *Anal. Biochem.*, 1999, **267**, 30.

- 1 57 X. Li, F. Zhang and D. Zhao, *Chem. Soc. Rev.*, 2014, **44**, 1346.
58 X. Chen, D. Peng, Q. Ju and F. Wang, *Chem. Soc. Rev.*, 2014,
44, 1318.
59 X. Yan, G. R. Fern, R. Withnall and J. Silver, *Nanoscale*,
5 2013, **5**, 1091.
60 S. Polizzi, S. Bucella, A. Speghini, F. Vetrone, R. Naccache,
J. C. Boyer and J. A. Capobianco, *Chem. Mater.*, 2004, **16**, 1330.
61 F. Vetrone, J. C. Boyer, J. A. Capobianco, A. Speghini and
M. Bettinelli, *Nanotechnology*, 2004, **15**, 75.
10 62 E. Nakazawa and S. Shionoya, *Phys. Rev. Lett.*, 1970,
25, 1710.
63 F. Wang, R. R. Deng, J. Wang, Q. X. Wang, Y. Han,
H. M. Zhu, X. Y. Chen and X. G. Liu, *Nat. Mater.*, 2011,
10, 968.
15 64 L. Tu, X. Liu, F. Wu and H. Zhang, *Chem. Soc. Rev.*, 2015,
44, 1331.
65 H. Dong, L.-D. Sun and C.-H. Yan, *Chem. Soc. Rev.*, 2015,
44, 1608.
66 G. Y. Chen, C. H. Yang and P. N. Prasad, *Acc. Chem. Res.*,
20 2013, **46**, 1474.
67 Q. Q. Su, S. Y. Han, X. J. Xie, H. M. Zhu, H. Y. Chen,
C. K. Chen, R. S. Liu, X. Y. Chen, F. Wang and X. G. Liu,
J. Am. Chem. Soc., 2012, **134**, 20849.
68 C. T. Xu, Q. Q. Zhan, H. C. Liu, G. Somesfalean, J. Qian,
S. L. He and S. Andersson-Engels, *Laser Photonics Rev.*,
25 2013, **7**, 663.
69 W. Yin, L. Zhao, L. Zhou, Z. Gu, X. Liu, G. Tian, S. Jin,
L. Yan, W. Ren, G. Xing and Y. Zhao, *Chem. – Eur. J.*, 2012,
18, 9239.
30 70 T. Yang, Y. Sun, Q. Liu, W. Feng, P. Yang and F. Li,
Biomaterials, 2012, **33**, 3733.
71 A. Gnach, K. Prorok, M. Misiak, B. Cichy and
A. Bednarkiewicz, *J. Rare Earths*, 2014, **32**, 207.
72 G. Y. Chen, T. Y. Ohulchanskyy, R. Kumar, H. Agren and
P. N. Prasad, *ACS Nano*, 2010, **4**, 3163.
35 73 J. Ryu, H. Y. Park, K. Kim, H. Kim, J. H. Yoo, M. Kang,
K. Im, R. Grailhe and R. Song, *J. Phys. Chem. C*, 2010,
114, 21077.
74 G. Gao, C. L. Zhang, Z. J. Zhou, X. Zhang, J. B. Ma, C. Li,
W. L. Jin and D. X. Cui, *Nanoscale*, 2013, **5**, 351.
40 75 M. Pedroni, F. Piccinelli, T. Passuello, S. Polizzi, J. Ueda,
P. Haro-Gonzalez, L. M. Maestro, D. Jaque, J. Garcia-Sole,
M. Bettinelli and A. Speghini, *Cryst. Growth Des.*, 2013,
13, 4906.
45 76 I. X. Cantarelli, M. Pedroni, F. Piccinelli, P. Marzola,
F. Boschi, G. Conti, A. Sbarbati, P. Bernardi, E. Mosconi,
L. Perbellini, L. Marongiu, M. Donini, S. Dusi, L. Sorace,
C. Innocenti, E. Fantechi, C. Sangregorio and A. Speghini,
Biomater. Sci., 2014, **2**, 1158.
50 77 J. Liu, Y. Liu, W. Bu, J. Bu, Y. Sun, J. Du and J. Shi, *J. Am.*
Chem. Soc., 2014, **136**, 9701.
78 L. Liu, F. Qin, H. Zhao, T. Lv, Z. Zhang and W. Cao, *Opt.*
Lett., 2013, **38**, 2101.
79 J. A. Damasco, G. Chen, W. Shao, H. Agren, H. Huang,
W. Song, J. F. Lovell and P. N. Prasad, *ACS Appl. Mater.*
55 *Interfaces*, 2014, **6**, 13884.
80 A. Priyam, N. M. Idris and Y. Zhang, *J. Mater. Chem.*, 2012,
22, 960.
81 Z. Li, S. Lv, Y. Wang, S. Chen and Z. Liu, *J. Am. Chem. Soc.*,
2015, **137**, 3421.
82 J. Peng, W. Xu, C. L. Teoh, S. Han, B. Kim, A. Samanta,
J. C. Er, L. Wang, L. Yuan, X. Liu and Y.-T. Chang, *J. Am.*
Chem. Soc., 2015, **137**, 2336.
83 T. Y. Cao, Y. Yang, Y. A. Gao, J. Zhou, Z. Q. Li and F. Y. Li,
Biomaterials, 2011, **32**, 2959.
84 L. C. Ong, L. Y. Ang, S. Alonso and Y. Zhang, *Biomaterials*,
2014, **35**, 2987.
85 D. Ni, J. Zhang, W. Bu, H. Xing, F. Han, Q. Xiao, Z. Yao,
F. Chen, Q. He, J. Liu, S. Zhang, W. Fan, L. Zhou, W. Peng
and J. Shi, *ACS Nano*, 2014, **8**, 1231.
86 X. Zhu, B. Da Silva, X. Zou, B. Shen, Y. Sun, W. Feng and
F. Li, *RSC Adv.*, 2014, **4**, 23580.
87 Y. H. Chien, Y. L. Chou, S. W. Wang, S. T. Hung,
M. C. Liau, Y. J. Chao, C. H. Su and C. S. Yeh, *ACS Nano*,
2013, **7**, 8516.
88 C. Wang, L. Cheng, Y. Liu, X. Wang, X. Ma, Z. Deng, Y. Li
and Z. Liu, *Adv. Funct. Mater.*, 2013, **23**, 3077.
89 R. J. McNichols, A. Gowda, M. Kangasniemi, J. A. Bankson,
R. E. Price and J. D. Hazle, *Lasers Surg. Med.*, 2004, **34**, 48.
90 J. Torres-Reveron, H. Tomasiewicz, A. Shetty,
N. Amankulor and V. Chiang, *J. Neurooncol.*, 2013,
25 **113**, 495.
91 Q. Zhan, J. Qian, H. Liang, G. Somesfalean, D. Wang, S. He,
Z. Zhang and S. Andersson-Engels, *ACS Nano*, 2011,
5, 3744.
92 G. Y. Chen, T. Y. Ohulchanskyy, A. Kachynski, H. Agren
and P. N. Prasad, *ACS Nano*, 2011, **5**, 4981.
93 J. Shen, G. Y. Chen, A. M. Vu, W. Fan, O. S. Bilsel,
C. C. Chang and G. Han, *Adv. Opt. Mater.*, 2013, **1**, 644.
94 Y. F. Wang, G. Y. Liu, L. D. Sun, J. W. Xiao, J. C. Zhou and
C. H. Yan, *ACS Nano*, 2013, **7**, 7200.
35 95 X. J. Xie, N. Y. Gao, R. R. Deng, Q. Sun, Q. H. Xu and
X. G. Liu, *J. Am. Chem. Soc.*, 2013, **135**, 12608.
96 Y. Zhong, G. Tian, Z. Gu, Y. Yang, L. Gu, Y. Zhao, Y. Ma and
J. Yao, *Adv. Mater.*, 2014, **26**, 2831.
97 A. Bednarkiewicz, D. Wawrzynczyk, M. Nyk and W. Streck,
Opt. Mater., 2011, **33**, 1481.
98 D. Wawrzynczyk, A. Bednarkiewicz, M. Nyk, W. Streck and
M. Samoc, *Nanoscale*, 2013, **5**, 12671.
99 M. C. Tan, G. A. Kumar, R. E. Riman, M. G. Brik, E. Brown
and U. Hommerich, *J. Appl. Phys.*, 2009, **106**, 063118.
45 100 G. Y. Chen, T. Y. Ohulchanskyy, S. Liu, W. C. Law, F. Wu,
M. T. Swihart, H. Agren and P. N. Prasad, *ACS Nano*, 2012,
6, 2969.
101 M. Y. Xie, L. Yu, H. He and X. F. Yu, *J. Solid State Chem.*,
2009, **182**, 597.
50 102 H.-S. Qian and Y. Zhang, *Langmuir*, 2008, **24**, 12123.
103 I. Villa, A. Vedda, I. Cantarelli, M. Pedroni, F. Piccinelli,
M. Bettinelli, A. Speghini, M. Quintanilla, F. Vetrone,
U. Rocha, C. Jacinto, E. Carrasco, F. Rodríguez,
Á. Juarranz, B. del Rosal, D. Ortgies, P. Gonzalez, J. Solé
55 and D. García, *Nano Res.*, 2014, **1**.

- 1 104 U. Rocha, C. Jacinto, W. F. Silva, I. Guedes, A. Benayas, L. M. Maestro, M. A. Elias, E. Bovero, F. C. J. M. van Veggel, J. A. G. Sole and D. Jaque, *ACS Nano*, 2013, 7, 1188.
- 105 D. Cauzzi, R. Pattacini, M. Delferro, F. Dini, C. Di Natale, R. Paolesse, S. Bonacchi, M. Montalti, N. Zaccheroni, M. Calvaresi, F. Zerbetto and L. Prodi, *Angew. Chem., Int. Ed.*, 2012, 51, 9662.
- 106 M. Pokhrel, L. C. Mimun, B. Yust, G. A. Kumar, A. Dhanale, L. Tang and D. K. Sardar, *Nanoscale*, 2014, 6, 1667.
- 10 107 L. C. Mimun, G. Ajithkumar, M. Pokhrel, B. G. Yust, Z. G. Elliott, F. Pedraza, A. Dhanale, L. Tang, A. L. Lin, V. P. Dravid and D. K. Sardar, *J. Mater. Chem. B*, 2013, 1, 5702.
- 108 F. Liu, Q. Zhao, H. You and Z. Wang, *Nanoscale*, 2013, 5, 1047.
- 15 109 X. Li, R. Wang, F. Zhang, L. Zhou, D. Shen, C. Yao and D. Zhao, *Sci. Rep.*, 2013, 3, 3536.
- 110 P. C. Lauterbur, *Nature*, 1973, 242, 190.
- 111 M. Botta and L. Tei, *Eur. J. Inorg. Chem.*, 2012, 1945.
- 20 112 I. Bertini, C. Luchinat and G. Parigi, *Solution NMR of Paramagnetic Molecules: Applications to metalloproteins and models*, 2001.
- 113 J. Kowalewski and L. Mäler, *Nuclear Spin Relaxation in Liquids: Theory, Experiments, and Applications*, CRC Press, 2006.
- 25 114 M. H. Levitt, *Spin Dynamics: Basics of Nuclear Magnetic Resonance*, John Wiley & Sons Ltd, Chichester, 2nd edn, 2007.
- 115 F. Carniato, K. Thangavel, L. Tei and M. Botta, *J. Mater. Chem. B*, 2013, 1, 2442.
- 30 116 D. Kruk and J. Kowalewski, *J. Magn. Reson.*, 2003, 162, 229.
- 117 P. Caravan, J. J. Ellison, T. J. McMurry and R. B. Lauffer, *Chem. Rev.*, 1999, 99, 2293.
- 118 M. Botta, *Eur. J. Inorg. Chem.*, 2000, 399.
- 35 119 Y. Ayant, E. Belorizky, J. Aluzon and J. Gallice, *J. Phys.*, 1975, 36, 991.
- 120 B. Halle, *J. Chem. Phys.*, 2003, 119, 12372.
- 121 D. Frezzato, F. Rastrelli and A. Bagno, *J. Phys. Chem. B*, 2006, 110, 5676.
- 40 122 A. J. L. Villaraza, A. Bumb and M. W. Brechbiel, *Chem. Rev.*, 2010, 110, 2921.
- 123 W. Xu, K. Kattel, J. Y. Park, Y. Chang, T. J. Kim and G. H. Lee, *Phys. Chem. Chem. Phys.*, 2012, 14, 12687.
- 124 S. H. Lee, B. H. Kim, H. B. Na and T. Hyeon, *Wiley Interdiscip. Rev.: Nanomed. Nanobiotechnol.*, 2014, 6, 196.
- 45 125 J. Y. Park, M. J. Baek, E. S. Choi, S. Woo, J. H. Kim, T. J. Kim, J. C. Jung, K. S. Chae, Y. Chang and G. H. Lee, *ACS Nano*, 2009, 3, 3663.
- 126 J. Y. Park, E. S. Choi, M. J. Baek, G. H. Lee, S. Woo and Y. Chang, *Eur. J. Inorg. Chem.*, 2009, 2477.
- 50 127 E. S. Choi, J. Y. Park, M. J. Baek, W. Xu, K. Kattel, J. H. Kim, J. J. Lee, Y. Chang, T. J. Kim, J. E. Bae, K. S. Chae, K. J. Suh and G. H. Lee, *Eur. J. Inorg. Chem.*, 2010, 4555.
- 128 M. Ahren, L. Selegard, A. Klasson, F. Soderlind, N. Abrikosova, C. Skoglund, T. Bengtsson, M. Engstrom, P.-O. Kall and K. Uvdal, *Langmuir*, 2010, 26, 5753.
- 129 L. Faucher, M. Tremblay, J. Lagueur, Y. Gossuin and M.-A. Fortin, *ACS Appl. Mater. Interfaces*, 2012, 4, 4506.
- 130 H. Hifumi, S. Yamaoka, A. Tanimoto, T. Akatsu, Y. Shindo, A. Honda, D. Citterio, K. Oka, S. Kuribayashi and K. Suzuki, *J. Mater. Chem.*, 2009, 19, 6393.
- 5 131 F. Evanics, P. R. Diamente, F. van Veggel, G. J. Stanisz and R. S. Prosser, *Chem. Mater.*, 2006, 18, 2499.
- 132 N. J. J. Johnson, A. Korinek, C. Dong and F. C. J. M. van Veggel, *J. Am. Chem. Soc.*, 2012, 134, 11068.
- 133 N. J. J. Johnson, W. Oakden, G. J. Stanisz, R. S. Prosser and F. C. J. M. van Veggel, *Chem. Mater.*, 2011, 23, 3714.
- 10 134 F. Chen, W. B. Bu, S. J. Zhang, J. N. Liu, W. P. Fan, L. P. Zhou, W. J. Peng and J. L. Shi, *Adv. Funct. Mater.*, 2013, 23, 298.
- 135 F. Chen, W. Bu, S. Zhang, X. Liu, J. Liu, H. Xing, Q. Xiao, L. Zhou, W. Peng, L. Wang and J. Shi, *Adv. Funct. Mater.*, 2011, 21, 4285.
- 15 136 R. M. Petoral, Jr., F. Soderlind, A. Klasson, A. Suska, M. A. Fortin, N. Abrikosova, L. Selegard, P.-O. Kall, M. Engstrom and K. Uvdal, *J. Phys. Chem. C*, 2009, 113, 6913.
- 137 Y. Li, T. Chen, W. Tan and D. R. Talham, *Langmuir*, 2014, 30, 5873.
- 20 138 T. Passuello, M. Pedroni, F. Piccinelli, S. Polizzi, P. Marzola, S. Tambalo, G. Conti, D. Benati, F. Vetrone, M. Bettinelli and A. Speghini, *Nanoscale*, 2012, 4, 7682.
- 139 F. Chen, W. B. Bu, S. J. Zhang, X. H. Liu, J. N. Liu, H. Y. Xing, Q. F. Xiao, L. P. Zhou, W. J. Peng, L. Z. Wang and J. L. Shi, *Adv. Funct. Mater.*, 2011, 21, 4285.
- 25 140 S. A. Ossen, S. Lechevallier, M. Verelst, P. Perriat, J. Dexpert-Ghys, D. Neumeyer, R. Garcia, F. Mayer, K. Djanashvili, J. A. Peters, E. Magdeleine, H. Gros-Dagnac, P. Celsis and R. Mauricot, *Nanoscale*, 2014, 6, 555.
- 141 A. Xia, M. Chen, Y. Gao, D. Wu, W. Feng and F. Li, *Biomaterials*, 2012, 33, 5394.
- 142 M. F. Dumont, H. A. Hoffman, P. R. S. Yoon, L. S. Conklin, S. R. Saha, J. Paglione, R. W. Sze and R. Fernandes, *Bioconjugate Chem.*, 2014, 25, 129.
- 35 143 M. Mahmoudi, K. Azadmanesh, M. A. Shokrgozar, W. S. Journeay and S. Laurent, *Chem. Rev.*, 2011, 111, 3407.
- 144 Q. Liu, M. Chen, Y. Sun, G. Y. Chen, T. S. Yang, Y. Gao, X. Z. Zhang and F. Y. Li, *Biomaterials*, 2011, 32, 8243.
- 40 145 J. Zhou, M. X. Yu, Y. Sun, X. Z. Zhang, X. J. Zhu, Z. H. Wu, D. M. Wu and F. Y. Li, *Biomaterials*, 2011, 32, 1148.
- 146 Y. Sun, M. X. Yu, S. Liang, Y. J. Zhang, C. G. Li, T. T. Mou, W. J. Yang, X. Z. Zhang, B. A. Li, C. H. Huang and F. Y. Li, *Biomaterials*, 2011, 32, 2999.
- 45 147 M. Helle, E. Rampazzo, M. Monchanin, F. Marchal, F. Guillemain, S. Bonacchi, F. Salis, L. Prodi and L. Bezdetnaya, *ACS Nano*, 2013, 7, 8645.
- 148 Q. Liu, Y. Sun, C. Li, J. Zhou, C. Li, T. Yang, X. Zhang, T. Yi, D. Wu and F. Li, *ACS Nano*, 2011, 5, 3146.
- 50 149 T. Cao, Y. Yang, Y. Sun, Y. Wu, Y. Gao, W. Feng and F. Li, *Biomaterials*, 2013, 34, 7127.
- 150 J. Lee, T. S. Lee, J. Ryu, S. Hong, M. Kang, K. Im, J. H. Kang, S. M. Lim, S. Park and R. Song, *J. Nucl. Med.*, 2013, 54, 96.
- 55 151 J. G. Llorente, M. G. Gallego and A. M. Arnaiz, *Acta Radiol.*, 1997, 38, 121.

- 1 152 S. Aime, M. Botta, M. Panero, M. Grandi and F. Uggeri, *Magn. Reson. Chem.*, 1991, **29**, 923.
- 153 R. Shukla, M. Fernandez, R. K. Piliyal, R. Ranganathan, P. C. Ratsep, X. Zhang and M. F. Tweedle, *Magn. Reson. Med.*, 1996, **35**, 928.
- 5 154 D. H. Powell, A. E. Merbach, G. González, E. Brücher, K. Micskei, M. F. Ottaviani, K. Köhler, A. Von Zelewsky, O. Y. Grinberg and Y. S. Lebedev, *Helv. Chim. Acta*, 1993, **76**, 2129.
- 10 155 S. Aime, P. L. Anelli, M. Botta, F. Fedeli, M. Grandi, P. Paoli and F. Uggeri, *Inorg. Chem.*, 1992, **31**, 2422.
- 156 S. I. Kang, R. S. Ranganathan, J. E. Emswiler, K. Kumar, J. Z. Gougoutas, M. F. Malley and M. F. Tweedle, *Inorg. Chem.*, 1993, **32**, 2912.
- 15 157 X. Zhang, C. A. Chang, H. G. Brittain, J. M. Garrison, J. Telser and M. F. Tweedle, *Inorg. Chem.*, 1992, **31**, 5597.
- 158 J. Rudovský, M. Botta, P. Hermann, K. I. Hardcastle, I. Lukeš and S. Aime, *Bioconjugate Chem.*, 2006, **17**, 975.
- 159 T. Koullourou, L. S. Natrajan, H. Bhavsar, Pope, J. Feng, J. Narvainen, R. Shaw, E. Scales, R. Kauppinen, A. M. Kenwright and S. Faulkner, *J. Am. Chem. Soc.*, 2008, **130**, 2178.
- 20 160 G. Dehaen, S. V. Eliseeva, P. Verwilt, S. Laurent, L. Vander Elst, R. N. Muller, W. De Borggraeve, K. Binnemans and T. N. Parac-Vogt, *Inorg. Chem.*, 2012, **51**, 8775.
- 25 161 M. Querol, J. W. Chen, R. Weissleder and A. Bogdanov, *Org. Lett.*, 2005, **7**, 1719.
- 162 M. O. Breckwoldt, J. W. Chen, L. Stangenberg, E. Aikawa, E. Rodriguez, S. Qiu, M. A. Moskowitz and R. Weissleder, *Proc. Natl. Acad. Sci. U. S. A.*, 2008, **105**, 18584.
- 30 163 J. E. Jones, A. J. Amoroso, I. M. Dorin, G. Parigi, B. D. Ward, N. J. Buurma and S. J. A. Pope, *Chem. Commun.*, 2011, **47**, 3374.
- 164 E. Debroye, M. Ceulemans, L. Vander Elst, S. Laurent, R. N. Muller and T. N. Parac-Vogt, *Inorg. Chem.*, 2014, **53**, 1257.
- 35 165 A. Keliris, T. Ziegler, R. Mishra, R. Pohmann, M. G. Sauer, K. Ugurbil and J. Engelmann, *Bioorg. Med. Chem.*, 2011, **19**, 2529.
- 166 G. Schuhmann-Giampieri, H. Schmitt-Willich, T. Frenzel, W.-R. Press and H.-J. Weinmann, *Invest. Radiol.*, 1991, **26**, 969.
- 40 167 C. T. Adkins, J. N. Dobish, C. S. Brown, B. Mayrsohn, S. K. Hamilton, F. Udoji, K. Radford, T. E. Yankeelov, J. C. Gore and E. Harth, *Polym. Chem.*, 2012, **3**, 390.
- 45 168 S. Laus, A. Sour, R. Ruloff, É. Tóth and A. E. Merbach, *Chem. – Eur. J.*, 2005, **11**, 3064.
- 169 P. D. Garimella, A. Datta, D. W. Romanini, K. N. Raymond and M. B. Francis, *J. Am. Chem. Soc.*, 2011, **133**, 14704.
- 50 170 L. Moriggi, C. Cannizzo, E. Dumas, C. R. Mayer, A. Ulianov and L. Helm, *J. Am. Chem. Soc.*, 2009, **131**, 10828.
- 171 D. Gerion, J. Herberg, R. Bok, E. Gjersing, E. Ramon, R. Maxwell, J. Kurhanewicz, T. F. Budinger, J. W. Gray, M. A. Shuman and F. F. Chen, *J. Phys. Chem. C*, 2007, **111**, 12542.
- 172 L. Tei, G. Gugliotta, Z. Baranyai and M. Botta, *Dalton Trans.*, 2009, 9712.
- 173 F. Kielar, L. Tei, E. Terreno and M. Botta, *J. Am. Chem. Soc.*, 2010, **132**, 7836.
- 5 174 L. M. Manus, D. J. Mastarone, E. A. Waters, X.-Q. Zhang, E. A. Schultz-Sikma, K. W. MacRenaris, D. Ho and T. J. Meade, *Nano Lett.*, 2010, **10**, 484.
- 175 S. J. McLachlan, M. R. Morris, M. A. Lucas, R. A. Fisco, M. N. Eakins, D. R. Fowler, R. B. Scheetz and A. Y. Olukotun, *J. Magn. Reson. Imaging*, 1994, **4**, 301.
- 10 176 A. E. Stillman, N. Wilke and M. Jerosch-Herold, *J. Magn. Reson. Imaging*, 1997, **7**, 765.
- 177 Y. Anzai, J. A. Brunberg and R. B. Lufkin, *J. Magn. Reson. Imaging*, 1997, **7**, 774.
- 178 K. R. Hurley, Y.-S. Lin, J. Zhang, S. M. Egger and C. L. Haynes, *Chem. Mater.*, 2013, **25**, 1968.
- 179 P. J. Endres, T. Paunesku, S. Vogt, T. J. Meade and G. E. Woloschak, *J. Am. Chem. Soc.*, 2007, **129**, 15760.
- 20 180 W. J. Rieter, J. S. Kim, K. M. L. Taylor, H. An, W. Lin, T. Tarrant and W. Lin, *Angew. Chem., Int. Ed.*, 2007, **46**, 3680.
- 20 181 H. Yang, Y. Zhuang, H. Hu, X. Du, C. Zhang, X. Shi, H. Wu and S. Yang, *Adv. Funct. Mater.*, 2010, **20**, 1733.
- 182 F. Carniato, L. Tei, W. Dastru, L. Marchese and M. Botta, *Chem. Commun.*, 2009, 1246.
- 25 183 F. Carniato, L. Tei, M. Cossi, L. Marchese and M. Botta, *Chem. – Eur. J.*, 2010, **16**, 10727.
- 184 J. L. Vivero-Escoto, K. M. L. Taylor-Pashow, R. C. Huxford, J. Della Rocca, C. Okoruwa, H. An, W. Lin and W. Lin, *Small*, 2011, **7**, 3519.
- 30 185 D. Kryza, J. Taleb, M. Janier, L. Marmuse, I. Miladi, P. Bonazza, C. Louis, P. Perriat, S. Roux, O. Tillement and C. Billotey, *Bioconjugate Chem.*, 2011, **22**, 1145.
- 186 G. Liang, L. Cao, H. Chen, Z. Zhang, S. Zhang, S. Yu, X. Shen and J. Kong, *J. Mater. Chem. B*, 2013, **1**, 629.
- 35 187 Y. Hou, R. Qiao, F. Fang, X. Wang, C. Dong, K. Liu, C. Liu, Z. Liu, H. Lei, F. Wang and M. Gao, *ACS Nano*, 2013, **7**, 330.
- 188 Y. Sun, Q. Liu, J. Peng, W. Feng, Y. Zhang, P. Yang and F. Li, *Biomaterials*, 2013, **34**, 2289.
- 189 Y. Liu, K. Ai, J. Liu, Q. Yuan, Y. He and L. Lu, *Angew. Chem., Int. Ed.*, 2012, **51**, 1437.
- 40 190 C. Haller and I. Hizoh, *Invest. Radiol.*, 2004, **39**, 149.
- 191 Y. Q. Wu, Y. Sun, X. J. Zhu, Q. Liu, T. Y. Cao, J. J. Peng, Y. Yang, W. Feng and F. Y. Li, *Biomaterials*, 2014, **35**, 4699.
- 45 192 Z. Liu, F. Pu, S. Huang, Q. Yuan, J. Ren and X. Qu, *Biomaterials*, 2013, **34**, 1712.
- 193 S. Zeng, M. K. Tsang, C. F. Chan, K. L. Wong and J. Hao, *Biomaterials*, 2012, **33**, 9232.
- 194 C. Lutzweiler, R. Meier, E. Rummeny, V. Ntziachristos and D. Razansky, *Opt. Lett.*, 2014, **39**, 4061.
- 50 195 M. Gerling, Y. Zhao, S. Nania, K. J. Norberg, C. S. Verbeke, B. Englert, R. V. Kuiper, A. Bergstrom, M. Hassan, A. Neesse, J. M. Lohr and R. L. Heuchel, *Theranostics*, 2014, **4**, 604.
- 196 S. K. Maji, S. Sreejith, J. Joseph, M. Lin, T. He, Y. Tong, H. Sun, S. W.-K. Yu and Y. Zhao, *Adv. Mater.*, 2014, **26**, 5633.