

Alma Mater Studiorum Università di Bologna
Archivio istituzionale della ricerca

Millimeter-Wave Propagation: Characterization and modeling toward fifth-generation systems. [Wireless Corner]

This is the final peer-reviewed author's accepted manuscript (postprint) of the following publication:

Published Version:

Millimeter-Wave Propagation: Characterization and modeling toward fifth-generation systems. [Wireless Corner] / Salous, Sana; Degli Esposti, Vittorio; Fuschini, Franco; Thomae, Reiner S.; Mueller, Robert; Dupleich, Diego; Haneda, Katsuyuki; Molina Garcia-Pardo, Jose-Maria; Pascual Garcia, Juan; Gaillot, Davy P.; Hur, Sooyoung; Nekovee, Maziar. - In: IEEE ANTENNAS & PROPAGATION MAGAZINE. - ISSN 1045-9243. - ELETTRONICO. - 58:6(2016), pp. 7762981.115-7762981.127. [10.1109/MAP.2016.2609815]

Availability:

This version is available at: <https://hdl.handle.net/11585/586432> since: 2018-02-23

Published:

DOI: <http://doi.org/10.1109/MAP.2016.2609815>

Terms of use:

Some rights reserved. The terms and conditions for the reuse of this version of the manuscript are specified in the publishing policy. For all terms of use and more information see the publisher's website.

This item was downloaded from IRIS Università di Bologna (<https://cris.unibo.it/>).
When citing, please refer to the published version.

(Article begins on next page)

This is the final peer-reviewed accepted manuscript of:

S. Salous *et al.*

"Millimeter-Wave Propagation: Characterization and modeling toward fifth-generation systems. [Wireless Corner]"

in *IEEE Antennas and Propagation Magazine*, vol. 58, no. 6, pp. 115-127, Dec. 2016

The final published version is available online at:

<https://doi.org/10.1109/MAP.2016.2609815>

Rights / License:

The terms and conditions for the reuse of this version of the manuscript are specified in the publishing policy. For all terms of use and more information see the publisher's website.

This item was downloaded from IRIS Università di Bologna (<https://cris.unibo.it/>)

When citing, please refer to the published version.

Millimeter-wave Propagation Characterization and Modelling Towards 5G Systems

S. Salous, V. Degli Esposti, F. Fuschini, D. Dupleich, R. Müller, R. S. Thomä, K. Haneda, J.M. Molina-Garcia-Pardo, J. Pascual-Garcia, D. P. Gaillot, M. Nekovee, S. Hur

Abstract— In this paper propagation issues regarding the use of mm-waves in future wireless systems are discussed. Challenges of mm-wave radio propagation measurements and modelling are identified followed by a description of state of the art radio channel sounders. Both already available and still needed channel measurements and models are presented. Finally, current and future standardization issues are outlined with recommendations for future research.

Key words—*Millimeter-wave propagation, 5G, Millimeter-wave Measurements, Channel sounders, MIMO, Beamforming, Diffuse Scattering, Ray Tracing, Standards, FMCW, PRBS*

I. INTRODUCTION

Mobile data traffic is projected to increase 5000 fold by the year 2030 [1]. This increase in traffic can be met through increase in link-capacity, spectrum availability and massive densification of small cells. Recent advances in air-interface design provide spectral efficiency performance very close to the Shannon limit. There is, however, room for increase in spectral efficiency through techniques such as Coordinated Multi-Point (CoMP), Massive MIMO, interference management and cancellation [2]. At millimeter wave (mm-wave) bands between about 30-300 GHz, in addition to the techniques mentioned above, the availability of large contiguous blocks of spectrum of 1 GHz or more allow to achieve unprecedented link capacities and throughput densities. Moreover at these higher frequencies, the antenna elements are smaller, enabling the implementation of large antenna arrays for beam forming to compensate for propagation losses, and dramatically increase system performances. Since large arrays are very directive, adaptive beamforming techniques become necessary to cope with time

variations in the channel. We note that while a large number of antenna elements could be implemented on both base stations and terminals due to smaller size, this would also result in increased complexity of the RF frontend of mobile terminals. For these reasons, among others, the use of the higher range of mm-wave frequencies for mobile communications remains challenging.

Having access to such large blocks of spectrum also makes it possible in early deployments to tradeoff spectral efficiency for bandwidth, i.e. high data rates can be achieved even with low-order modulation schemes requiring lower power and lower complexity and cost.

For the above reasons, exploitation of mm-wave frequencies for 5G standards has started to gain considerable traction within the wireless industry, [3] and is also on the research agenda of European Union's (EU) Horizon 2020 5G PPP initiative [4]. Furthermore, following the World Radio Conference (WRC'15) where various frequency bands have been identified for possible allocation for future wireless networks, the International Telecommunications Union (ITU) study groups 3 and 5 are working towards a suitable channel model.

Proprietary WiFi-technologies operating in indoor environments in the 60 GHz ISM frequency band based on the IEEE 802.11ad and 802.15.3c standards are already commercially available [5] [6]. Recently, IEEE 802.11 Task Group AY was launched to develop enhanced standards for operation in license-exempt bands above 45 GHz. However, the development of mm-wave technologies for ultra-high capacity mobile communication is currently at an early stage. Although initial trials look promising [3], a number of challenges need to be overcome before the technology moves towards inclusion in 5G standards and extensive commercial deployment by 2020.

The EU Horizon 2020 research program also considers the extension of the wireless communications systems to frequencies above 60 GHz to fill the gap between the millimetre-wave and the terahertz spectrum. Furthermore, the first phase of EU's Horizon 2020 5G PPP initiative is investigating the 6-100 GHz frequencies, including mm-wave frequencies in this range, for 5G's ultra-high data rate mobile broadband [7]. The frequency range, between 60 GHz and 300 GHz is not limited to communications, but also finds application in remote sensing, security and industrial measurement. The use of this band has been proposed for high-speed data links, automotive radar, radar

Manuscript received ...

Sana Salous is with the School of Engineering and Computing Sciences, University of Durham, UK, (email: sana.salous@durham.ac.uk). Vittorio Degli-Esposti and Franco Fuschini are with the Dept. of Electrical, Electronic and Information Eng. "G. Marconi", University of Bologna (e-mail: v.degliestosti, franco.fuschini@unibo.it). D. Dupleich, R. Müller, R. S. Thomä, are with the Ilmenau University of Technology, K. Haneda is with the University of Aalto, K. Haneda is with the School of Electrical Engineering, Aalto University, (e-mail: Katsuyuki.haneda@aalto.fi), Jose-Maria Molina-Garcia-Pardo and Juan Pascual-Garcia (email: josemaria.molina@upct.es, juan.pascual@upct.es) are with the Universidad Politécnica de Cartagena, Davy P. Gaillot is with the University of Lille1, IEMN/TELICE, FR (email: davy.gaillot@univ-lille1.fr), Maziar Nekovee is with Samsung R&D Institute UK (SRUK) Sooyoung Hur is with Samsung Korea, (e-mail: sooyoung.hur@samsung.com)

imaging, security screening, substance identification and non-destructive testing among others [8][9][10].

One of the basic highly important challenges in the development of mm-wave technologies is the lack of appropriate channel models. The need for new channel models to support 5G networks planning has been recently reaffirmed during the 3GPP RAN Workshop on 5G held in Phoenix [11]. While significant studies of the channel characteristics are available in the 60 GHz band for indoor and short-range scenarios, and more recently for body networks [12] for secure communication, only a few trials have been conducted in other mm-wave band and for outdoor, outdoor-indoor, and scenarios with mobility [13]-[18].

Under the assumption that antenna dimensions must be related to the wavelength, and therefore antenna gains nearly constant with frequency, one important issue of mm-wave propagation is the higher path loss, as isotropic free-space attenuation is inversely proportional to the second power of the wavelength. The use of high-gain antenna arrays is therefore mandatory to mitigate this problem. Other important issues are gaseous and rain attenuation for longer range links, and the higher shadowing due to lower diffraction and penetration in case of LOS blockage from obstacles.

While information relating to gaseous and rain attenuation are well known and available from ITU-R recommendations ITU-R P676-10 and ITU-R P 530-9, there are no parameters related to path loss exponents apart from a very brief statement and to wideband channel parameters such as Root-Mean-Square (RMS) delay spread and angular spread in ITU-R 1411-8. Such models are of great importance in order to (i) develop and test the required physical and higher layer components (algorithms and architectures), (ii) perform link and system level feasibility studies, and (iii) investigate spectrum engineering regulatory issues such as interference risks and co-existence in the mm-wave bands.

Only a small number of studies address propagation characterization and modelling for very wide-bandwidth channels with directive arrays, such as those of beamforming transmission techniques, which may drastically influence channel characteristics [16][17][19]-[21]. Fundamental questions on the relation between the time dispersion of the channel and the directivity of the transmission lobe, or on the spatial, temporal and polarimetric characteristics of the propagation channel still need to find complete answers.

Because of the higher frequencies and wider bandwidths compared to existing standards for 4G cellular and WLAN below 6 GHz, mm-wave applications will need specific considerations. New radio interface technologies such as massive arrays will render basic assumptions for statistical channel models obsolete. Those robust models that performed very well for 4G for instance, assume that many propagation paths superimpose after OFDM processing. However, the much higher spatial resolution of high-gain analogue/hybrid beamforming before digitization and, hence, OFDM, enforce paradigm-shifts towards time-

domain concepts and deterministic modelling approaches [22].

The aim of this paper, therefore, is to provide the reader with an insight on recent research in important aspects of mm-wave propagation characterization and modelling, for future 5G systems and applications, with particular focus on research carried out within the European Cooperation Project “COST IC1004”. The relatively large body of results available for 60 GHz is taken as a starting point, but emphasis is placed on the recent results that are becoming available for outdoor and outdoor-indoor scenarios at other frequencies of interest including 28 GHz, 38 GHz and 70 GHz.

The rest of this paper is organized as follows: section II gives an overview of propagation characteristics based on available ITU-R recommendations and recent studies; section III describes state of the art channel sounding techniques available for mm-wave measurements; section IV presents an overview of propagation modelling including path loss models, shadowing models, stochastic channel models and models based on ray tracing; section V presents standardization prospects and finally section VI draws some conclusions and makes recommendations for further studies.

II. PROPAGATION CHARACTERISTICS

When designing radio links in the mm-wave band, it's in principle necessary to consider the additional attenuation due to gases in the lower atmosphere and rain. In the frequency range up to 100 GHz, two absorption peaks occur in standard atmosphere. The larger one is due to oxygen at 60 GHz and corresponds to 15 dB/km. Therefore gas attenuation should not represent a major concern for future mm-wave indoor and small-cell applications [13]. Similar considerations hold true for rain effects, with a maximum attenuation of about 30 dB/km for very heavy (100 mm/hr) rainfall.

A more important factor to consider is the high penetration loss of building materials. Typical relative permittivity and conductivity for different building materials are given in ITU-R 1238-8 [23], and other studies as reported by [24] and [25] while a comparative study between 5.8 GHz and 62.4 GHz is given by [26]. The ITU-R recommendation provides an expression for the conductivity σ - which gives rise to the dB/m specific attenuation factor - as a function of frequency f in GHz

$$\sigma = cf^d \text{ S/m} \quad (1)$$

where values for c and d are tabulated for different frequency ranges. For example for a concrete wall $c=0.0326$ and $d=0.8095$. This gives 0.0326 [S/m] at 1 GHz vs. 0.908 [S/m] at 60 GHz, leading to a much higher penetration loss. This is in agreement with measurements in [27] on a brick-wall, showing a permittivity value more than 10 times greater at 70 GHz than at UHF.

Reported penetration losses at 60 GHz are on the order of some dBs for very thin plastic, wood or plaster partitions, 4 dB for a 0.7 cm single-panel tempered glass and 25 dB for a 9 cm indoor brick wall when both the transmit and receive antennas are vertically polarised

[28][29]. Penetration losses at 70 GHz are similar to those at 60GHz and are summarized in Table 1 for some common materials.

Table 1 - Penetration losses at 70 GHz for some construction and furniture items (from [27])

Object	Loss	
	[dB]	[dB/cm]
Indoor brick wall (9 cm thick, with plaster on both surfaces)	25.3	2.8
PC Monitor (LCD monitor made of plastic, metal parts and glass)	34.0	5.7
Wooden bookshelf (30 cm deep with a back panel, filled with hard-cover books)	30.0	1.0
Plywood panel (1.3 cm thick)	2.7	2.1
Absorber Panel (flat carbon-loaded foam, 11 cm thick)	53.8	4.9

The frequency dependence of penetration loss has also been reported with variations between 18.9 dB at 900 MHz, 26 dB at 11.4 GHz to 36.2 at 28.8 GHz for a three-wall partition between antennas [30]. These additional losses at the higher frequencies will require compensation through higher effective radiated powers.

Polarization aspects have long been overlooked in mm-wave propagation as the majority of mm-wave links were originally conceived as stationary LOS links with directive antennas and polarization matching. With the application of mm-wave transmission to mobile environments, frequent LOS blockage and multipath propagation, the study of the polarimetric properties of mm-wave propagation has become important. Recent experimental investigations at 60 GHz using a channel sounder have shown that most multipath contributions are clearly polarization dependent as they appear or disappear from the channel's power profiles shown in Fig. 1 depending on the polarization of the Transmitter (Tx) and Receiver (Rx) antennas [31].

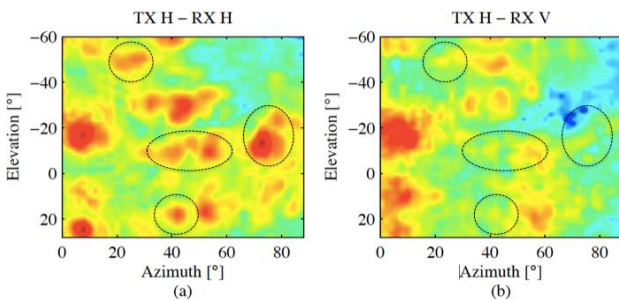

Fig- 1 - Power Angle Spectrum at the transmitter for HH polarization (a) and HV polarization (b) [31]

Another important issue of mm-wave propagation is rough-surface scattering. For rough construction materials such as concrete, bricks, asphalt, etc, the standard deviation of surface-roughness σ_h , is of the order of 1-2 mm, and therefore no longer satisfies the Rayleigh criterion, $\sigma_h < \lambda / (8 \cos \theta_i)$ as for lower frequencies [32]. This fact results in a lower specular reflectivity of the

surface in favour of some sort of diffuse reflection where each impinging ray is back-scattered into many low-amplitude rays having random propagation directions. Although some authors hypothesized for this reason a stronger Dense Multipath Component (DMC [33]) at mm-wave frequencies compared to lower frequencies, recent studies have shown that the actual ratio of the DMC to the Specular Component is similar [34][27], or even lower [35]. Probably the higher degree of rough-surface scattering for some surfaces is over-compensated by the lower level of multipath-richness due to the suppression of through-wall propagation and by the lower diffraction effects. This aspect is very important to properly design and assess the performance of beam forming techniques adopting narrow beams, recently proposed to enhance the SINR and to implement spatial multiplexing in future multi-Gigabit transmission systems [3].

The DMC affects the Spatial-Degrees-of-Freedom (SDoF) of the propagation channel and determines the extent of channel capacity improvement possible through eigenmode transmission. Even though mm-wave radio channels are said to be multipath sparse, [36] shows experimentally that up to 10 spatial eigenmodes are available in indoor propagation channels for the transmit and receive antenna aperture size of $9\lambda^2$ and the receive signal-to-noise ratio of 20 dB.

III. MM-WAVE CHANNEL SOUNDING

Full characterization of the radio channel at mm-waves requires the estimation of a number of parameters of the multipath components and the polarimetric characteristics of the channel. Multipath parameters include time delay, Doppler shift, angle of departure (AoD), angle of arrival (AoA) and a 2x2 matrix of polarimetric path weights. These are normally realised with a sophisticated channel sounder design using a wideband signal with a high Waveform Repetition Frequency (WRF). In addition, it is desirable to have an Instantaneous Dynamic Range (IDR) for each measured snapshot that enables the clear detection of the multipath components above the noise floor and a high overall dynamic range for a deeper understanding of the propagation channel.

The IDR relates to the maximum path power weight (just below the onset of nonlinear distortion) relative to the noise level in one channel impulse response function whereas the system dynamic range describes the dB-range between the highest and the lowest channel attenuation that can be processed along a recording track. The latter, can be controlled by the transmitter power and automatic gain control (AGC) which can be applied at either side or both sides of the link. To satisfy all of these requirements of high dynamic range, time delay resolution and angular resolution, estimation of Doppler shift and polarimetric measurements can be costly and even difficult to achieve.

To measure the AoA/AoD there are different options available. The first option is to use a single antenna element which has to be rotated or physically moved to multiple positions to form the full array (synthetic array) [37][38]. Measuring the channel in azimuth and in elevation would always require some 2D movement.

While some trials with planar positioning of omnidirectional antennas were reported, using high-gain antennas and rotation positioner allows well resolved directional characterisation without any sophisticated high resolution processing. However, full channel characterization (azimuth and elevation and double sided for AoA and DoD) is very time consuming and not applicable for dynamic scenarios. Fig. 2 (a) shows a set up at Durham University [39] with a lens antenna with 2.2° beam width rotated in azimuth in 5° steps to estimate the power delay profile as illustrated in Fig. 2 (b) for a typical urban outdoor environment with buildings on either side of the receiver.

The second measuring philosophy is to use real antennas instead of virtual arrays. A circular Uniform Beam Array (CUBA) [40] might be a good choice for fast directional resolution, see Fig. 3 [41]. For double arrays the transmitted waveforms have to be orthogonal either in time, in frequency or using codes. Fast channel sampling rates can be achieved with simultaneous multiple antenna transmissions using orthogonal codes which is generally complex with limited IDR and costly to implement.

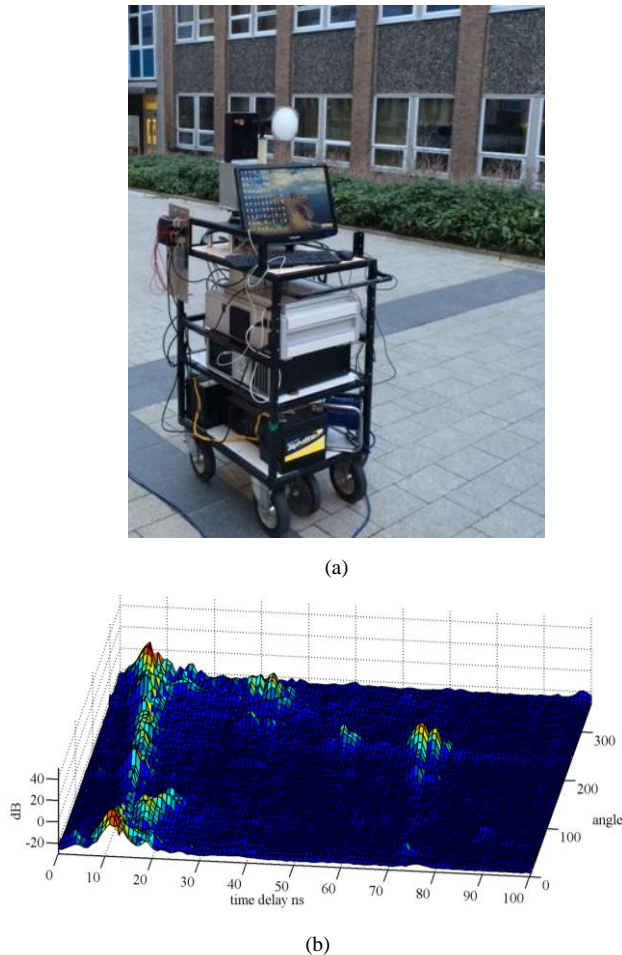

Fig. 2 (a) Receiver-Sounder with lens antenna, (b) measured power delay profile versus azimuthal angle [39]

Reception can also be achieved either using a single element or multiple elements. In the multiple element case, either a single receiver in conjunction with a switch can be used or multiple parallel receivers to speed up the acquisition. Antenna elements can be either omni-

directional or directional such as the CUBA array. Directional antenna elements provide a gain advantage in the mm-wave band due to the higher losses experienced in the environment and from the additional losses due to the atmosphere and rain for ranges in excess of a few hundred meters. This is the reason why most measurements in the mm-wave band are performed using directional antennas such as a horn antenna. A further advantage of these measurements can be the capability to generate beam-formed channel models. Due to the narrow beam width of the horn antenna and the high cost of employing parallel channels usually a single channel with extensive measurements are performed with small step increments to cover all azimuth directions (sometimes including elevation) [35][42][43]. This gives the power delay profiles as a function of angle of arrival and angle of departure when positioners are used on both sides of the link.

However, the synthetic aperture approach or rotating both the transmitter and receiver antennas to cover all combinations of azimuth and elevation angles takes considerable measurement time. The underlying assumption is that the channel is time invariant during the measurement time which can be difficult to achieve in real environments. In addition, due to the very small wavelength highly accurate positioners would be required on the order of a fraction of a wavelength to synthesize the array and sources with low phase noise and high stability would be needed to apply high resolution estimation algorithms.

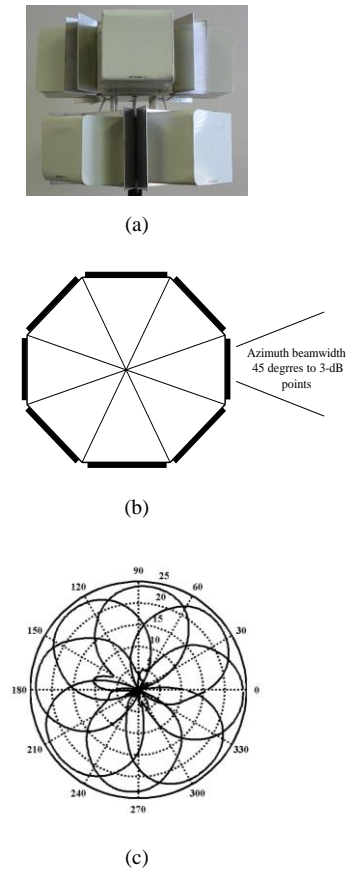

Fig. 3 - CUBA array: (a) picture; (b) angular separation and (c) radiation pattern [41].

In principle multiple antenna measurements enable the detailed estimation of the multipath parameters including the AoD and AoA using high resolution algorithms such as SAGE [44] or RIMAX [33] [45]. A drawback of SAGE is that 1) the computational load is dependent on the covariance matrix size which can be excessively huge for typical MIMO measurements and 2) it only assumes additive white Gaussian noise in the model and thus does not include DMC. This potentially results in obtaining a larger number of paths and unfaithful estimates as well as data spreads/distributions [46]. In contrast in the data model of RIMAX, the probability density function of a radio channel observation is a multivariate normal distribution. The SMC and DMC parameters are estimated by solving deterministic and stochastic maximum-likelihood problems, respectively. In addition the gradient based search in RIMAX results in a faster convergence than the independent parameter search of SAGE.

The mathematical ability to split the SMC and DMC from the measured radio channels is not only pivotal to understanding the mechanisms of each propagation component but also a prerequisite to developing advanced Geometric Stochastic Channel Models (GSCM) for the propagation scenarios defined in the upcoming standards. Moreover, this approach enables a joint polarimetric description of the SMC and DMC which is up to now missing in the literature. As an Example, Fig. 4 presents the SMC estimates (TOA and DOA/DOD azimuth) and DMC obtained from MIMO radio channels measured in the 57 – 66 GHz band with 1.12 GHz bandwidth (Position 5 in [47]). These VNA measurements were obtained with an omnidirectional antenna at the transmitter which was linearly moved in 2mm steps along 5 positions to form a virtual 5-element uniform linear array (ULA). For the receiver end the antenna was moved in 2 mm steps to form a 6 x 6 virtual uniform rectangular array (URA).

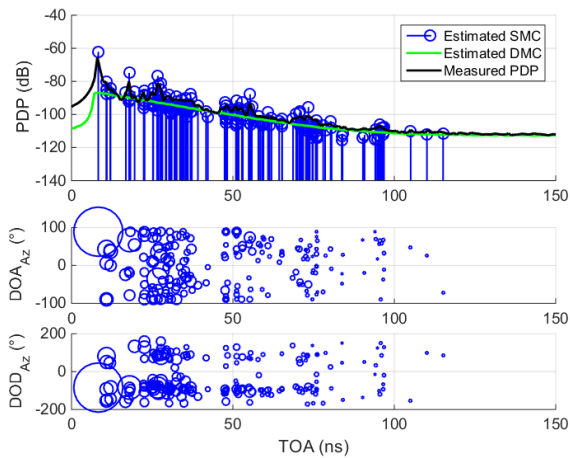

Fig. 4: Estimates of the SMC and DMC parameters: TOA (in ns), AoA/AoD (in °), for Position 5 from [46].

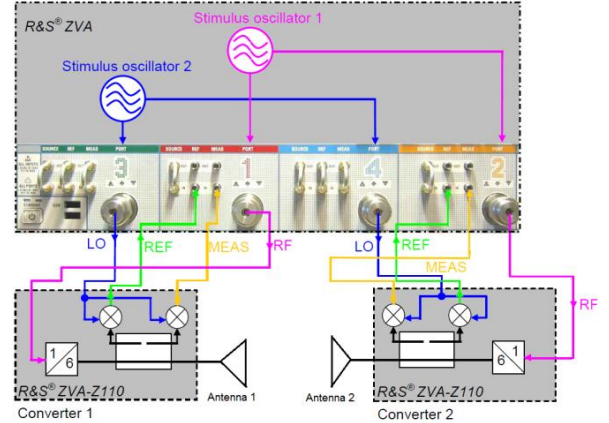

Fig. 5 - VNA-based millimeter-wave channel sounder [47]

Another parameter of interest in mm wave measurements is the resolution of multipath components which is related to the time delay resolution of the sounding equipment or equivalently the transmission bandwidth of the signal. Regardless of the number of antennas employed at the transmitter and receiver, channel sounding in the mm-wave band can be performed with a number of channel sounder waveforms and configurations ranging from commercial off the shelf equipment such as a vector network analyser (VNA) to custom designed sounders. The VNA can be employed in indoor measurements where the channel characteristics are assumed to be time-invariant for the duration of the sweep, or for CW measurements for the evaluation of narrowband transmissions. Wideband measurements with a large number of frequency samples requires long sweep times and can lead to a dispersed response due to movement [12]. In addition to the duration of the sweep, VNA's require the use of long cables since both the transmitter and receiver need to be connected to the same unit which reduces the range of the measurement or require an external amplifier to compensate for the cable loss. The use of cables at mm-waves can lead to distortion of the frequency sweep due to the phase instability and phase non-linearity over a wide bandwidth in the cables. The impact of phase distortion is a dispersed pulse with lower peak value which reduces the time delay resolution and a time variant response due to the cables rather than the radio channel. An alternative to using high loss cables with phase instability in the higher frequency bands is to use a VNA in the lower frequency bands with up and down converters as illustrated in Fig. 5 [47].

Another way to prevent the high loss of RF cables is to install an RF-over-fiber solution [48], [49]; the optical fibre has only a few dBs of losses for 100 m cable length, and furthermore, has gain at the electric/optical and optical/electric converters. However, this set up cannot be used for moving antenna platforms.

A custom designed sounder on the other hand can use separate transmitters and receivers and allow for outdoor cellular measurements as well as outdoor to indoor measurements and between floors. In the main such sounders use two different types of waveforms: continuous waveform with a Pseudo-Random Binary Sequence (PRBS) [41][42] and frequency modulated continuous wave (FMCW) [12] [51] [52]. Using a sliding

correlator in a PRBS sounder or a heterodyne detector at the receiver in a FMCW sounder compresses the bandwidth of the detected signal thereby alleviating the data acquisition requirements. Hence, wideband digital synthesizers or custom specific SiGe can be designed that allow very wide frequency bands and compact, low power devices [53]. Alternatively the data can be acquired with high speed sampling scopes [54]. However commercial off the shelf equipment typically have drawbacks if long un-sustained data recording and multiple device remote synchronized operation is required. A simplified scheme of a PRBS based channel sounder is depicted in Fig. 6.

PRBS sounders in the mm wave band tend to have short duration length sequences which are commensurate with the duration of the channel impulse response. The bandwidth of the PRBS waveform is related to the used chip technology and the time delay resolution achieved with such sounders is related to the clock rate of the chip. The spectrum of PRBS signal consists of discrete frequency components at multiples of the duration of the sequence and the envelope of the spectrum is that of a sinc/x function. The bandwidth of a PRBS sounder is usually reported as the bandwidth between the first two nulls of the spectrum which is equal to twice the clock rate of the chip. Nowadays, bandwidths greater than 10 GHz are no longer a challenge [42].

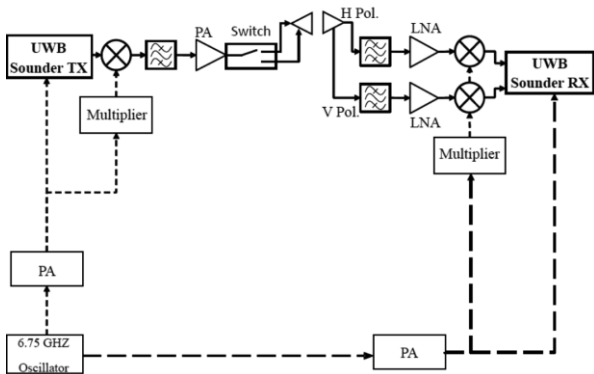

Figure 6 –PRBS-based channel sounder set-up [50]

The FMCW technique is enabled through the use of digital synthesizers that can be clocked at a high rate. High bandwidths can be achieved through frequency multiplication with bandwidths up to 6 GHz [51]. The technique allows bandwidth compression using a replica at the receiver of the transmitted waveform but with a sweep duration much longer than the maximum expected time delay e.g. 204.8-819.2 μs whereas the duration of the PRBS code should be sufficiently long to avoid range/time delay ambiguity e.g. 4.7 μs duration and a sampling rate of the channel equal to 3345 [42], [10]. Multiple antenna mm-wave sounders in the 60 GHz band have been reported for 2 by 2 antenna configurations [51] and a full polarimetric 2 by 4 channel sounder at 70 GHz and 60 GHz was reported in [42][55]. The transmit antennas are switched at the rate of the waveform duration while the receive channels are implemented in parallel. To avoid switching losses in the mm-wave band, the two transmit channels employed mm-wave RF heads with RF switching in the lower frequency band.

Sounders in the lower mm-wave ~28-30 GHz band have also been reported with PRBS sequences using 400 MHz clock rate and single horn antennas. Parameters estimated from the measurements included path loss coefficient, rms delay spread and angular spread using a highly directive horn antenna rotated in angle [13]. While these measurements have yielded some useful information, the measured bandwidth is smaller than expected for future 5G systems which are on the order of 2 GHz and the time taken to complete the rotation to obtain the angular information was significantly long that no Doppler information is reported.

Other waveforms used in channel sounding, is the multi-tone OFDM like signals such as in the RUSK sounder [56]. The waveform requires high speed Analogue to Digital converters commensurate with the transmission bandwidth.

The estimation of delay/Doppler/angular information requires the design of novel sounders with multiple antenna capability to permit the complete characterization of the channel. An example would be similar to the parallel receiver architecture developed for the 2 GHz band [52] with switched transmitter antenna with CUBA arrays. This approach has been recently developed at Durham University in the 30 GHz band with 8 by 8 antenna configuration. An alternative is the fully switched receiver architecture for mm-wave as reported in [57]. The realization of a 2 by 8 configuration with 45 degree directional antennas can provide a more rapid channel response which also covers angular spread in azimuth and in elevation.

A combination of two transmit channels in conjunction with a single pole four way switch each and a four way receiver with a single pole two way switch on each channel can reduce the cost of a full parallel system.

Future sounder design should take into account, cost, angular coverage and Doppler estimation. In addition, since the frequency allocation in the mm wave band is not yet determined a number of candidate frequencies are being proposed. Comparative simultaneous measurements in multiple frequency bands would be desirable. For the evaluation of backhaul links, a hub and several receiving locations with multiple frequency bands, and dual polarisation would be needed. The use of a distributed link sounder requires time and frequency synchronisation over multiple links. Similarly, the evaluation of multi-user beamforming requires a transmitter with multiple receiver units.

IV. PROPAGATION MODELLING

A. Deterministic and semi-deterministic models

As outlined in Section II, compared with UHF links mm-wave radio links are limited in range due to the higher propagation losses both in free space and through building material. The small wavelength leads to higher diffraction loss and higher scattering effects due to rough-surfaces. In addition, current power amplifiers in the mm-wave bands are currently limited to tens of dBm's. Therefore the propagation environment is intrinsically much smaller than at UHF, often limited to the room where the radio terminals are located or to Line Of Sight

(LOS) areas and areas just around building corners with respect to the transmitter. Furthermore, since mm-waves cannot penetrate deeply into walls and objects and the scattering from volume-irregularities (brick holes, presence of cables and pipes into walls, etc.) is much smaller, the influential propagation environment can be described as simpler and better defined with respect to UHF.

Considering all of these characteristics, deterministic ray models such as Ray Tracing (RT) or Ray Launching seem to represent the natural base to model mm-wave propagation. Being founded on a sound, albeit approximate, theory such as Ray Optics, ray-based models can be considered fairly reliable when the wavelength is small compared to the size of the obstacles and when the propagation environment is limited and therefore a detailed environment description is possible.

The representation of the scenario must include both its geometrical and electromagnetic properties. For reference, the electrical permittivity and the conductivity values measured on some common building materials at millimetre frequencies are listed in Table 2.

RT models represent an appropriate choice when it comes to deterministic, mm-wave propagation and channel modelling. The relatively small mm-wave propagation environment allows easy and fast RT prediction, thus overcoming its traditional drawback: high computation time. Moreover, due to its accuracy and versatility RT can be used to derive simpler path-loss models [63][64] or to directly perform multidimensional channel characterization, often in combination with measurements [33][65][66][67]. Since RT models by definition simulate multipath propagation, they can be used to evaluate and/or compare the performance of MIMO solutions (e.g. beamforming), which will be likely adopted in future mm-wave systems [22][68].

Table 2 – electromagnetic parameters at mm-wave for common building materials

Material	Freq. (GHz)	ϵ_R	σ [S/m]	Ref.
Brick Wall	60	2.5	1.4	[58]
		4.4	1	[59]
Cement	60	3	1.8	[58]
Concrete	60	6	1	[60]
Glass	41.5	3.4	--	[61]
	60	8.9	0.4	[59]
		6.5	0.7	[58]
Marble	60	11.5	0.3	[60]
Paper	30	2.3	0.2	[62]
	60	2.4	0.4	[62]
	90	2.5	0.6	[62]
Plasterboard	41.5	2.5	--	[62]
	60	2.8	0.3	[60]
Plexiglass	60	2.7	0.9	[58]
Plywood	41.5	1.7	--	[61]
	60	2.5	--	[61]
		2.4	2.7	[59]
Stone	60	6.8	0.9	[60]
Wood	30	2.5	0.2	[62]

60	2.4	0.4	[62]
	2.8	0.15	[58]
90	2.3	0.6	[62]

Ray models however need to be extended to include somehow diffuse scattering, for example using the Effective Roughness (ER) approach [69]. In [27] and [67] measurement campaigns were performed to determine the proper ER parameters for common indoor materials at 60 and 70 GHz. The characterization of diffuse scattering for outdoor materials and for other mm-wave bands different from the 60 and 70 GHz band is still an open issue.

The degree of diffuse scattering and therefore of DMC seems to vary for different environments: while a closed office room shows a comparable amount of DMC power as at UHF in [33], more open environments such as a shopping mall, large offices and a railway station seem to yield a lower degree of DMC at mm-waves compared to lower frequencies [34]. This could be due to the presence of surfaces having a small roughness compared to the wavelength, and to the large amount of reverberating energy in the considered environments.

With respect to UHF frequencies, small objects such as ceiling lamps, computer monitors and metal window frames seem to generate more evident and specular-like contributions, probably due to their larger size compared to the wavelength; such objects should be therefore taken into account to achieve good deterministic prediction accuracy [46]. Studies have been carried out lately to characterize the scattering pattern of common-use objects and materials. The measured and simulated scattering pattern of a brick wall slab is for example shown in Fig. 7 [31].

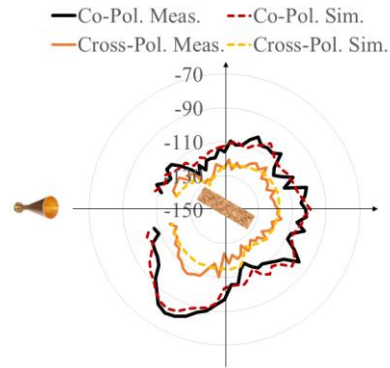

Figure 7 – Scattering pattern of a plastered brick wall slab at 70 GHz: anechoic chamber measurement vs. RT+ER simulation for co- and cross-polarization antenna states. The antenna symbol identifies the illumination direction.

The scattering effect of smaller objects can be included in RT models either in a deterministic way, i.e. characterizing their scattering pattern and introducing them as scatterers into the environment description, or in a statistical way through the cited ER model.

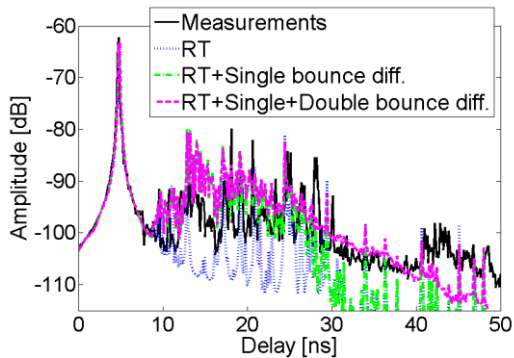
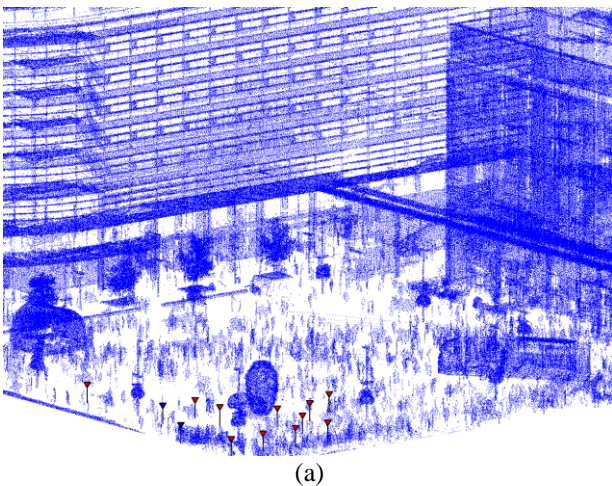

Fig. 8 - Measured and simulated PDP's at 60 GHz in an indoor environment. Simulation is performed using RT combined with the ER diffuse scattering model (from [68])

The latter approach is followed in [31] and [68]. In Fig. 8 the Power Delay Profile (PDP) measured at 60 GHz in an indoor environment is compared with three simulated PDP's using RT without diffuse scattering and with single or double-bounce diffuse scattering computed with the ER model. It is evident that the best results are achieved in the latter case.

To accurately include the effect of objects and small details, laser-scanning techniques are being used to derive accurate environment representations in a form of a set of points, which is called a point cloud. An example of the point cloud measured at an open square of dimension 80 x 80 m² is shown in Fig. 9 (a).

The point cloud covers objects such as lampposts, trees and human body that would be missing in many available environment databases. The point cloud furthermore records roughness of surfaces with the accuracy of the order of 1 mm.



(a)

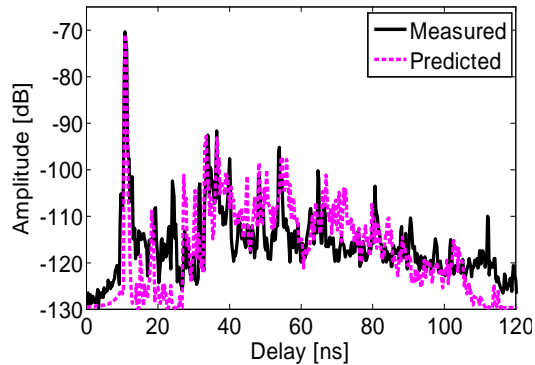

(b)

Fig. 9. (a) Point cloud geometrical database of an open square in Helsinki, Finland. (b) Power delay profiles measured and simulated for the open square scenario.

It is therefore well suited for high frequency channel simulations where these small irregularities in the environment may make differences in channels. Proper ray-based methods that can make use of such point-clouds – instead of flat polygonal surfaces – in the input database for channel simulation have been proposed recently [70]. A comparison of measured and simulated power delay profiles in the open square shown in Fig. 9 (a) is presented in Fig. 9 (b). The transmitter and receiver antennas are located in one of the red and green triangles in Fig. 9 (a), respectively [72]. The methods are capable of simulating specular components as well as the DMC [72].

Among the models easily applicable to a point-cloud representation of the environment, Graph Theory models are particularly interesting as they allow the modelling of an infinite number of bounces with a relatively low computation time [73][74]. They are very suitable to mm-wave and Terahertz propagation modelling in reverberant environments such as aircraft cabins and trains. The model however at present assumes highly diffuse back-scattering from obstacles, such as in the case of very rough surfaces or THz frequencies, as specular reflection cannot be easily handled by the algorithm.

B. Other propagation and channel models

Although deterministic and semi-deterministic models appear suitable for mm-wave propagation modelling, simplified and empirical-statistical models are still necessary when non site-specific results are needed, e.g. for system design or for simple and fast channel simulation. Such models are often referred to as statistical channel-models (rather than propagation-models) and are aimed at simulating statistical distributions such as the Power-Delay Profile (PDP), the Power-Angle-Profile (PAP), the Doppler Spectrum, etc, to assist in mm-wave device and system design [20].

Due to the large propagation loss and low power budget at mm-wave bands, the fundamental concern is the feasibility of NLOS links or of LOS links exceeding the 100-200 m range. Therefore reliable narrowband shadowing models and path-loss models are of vital importance for the design of mm-wave radio links. Due to the very high penetration attenuation and to the short

wavelength, even relatively small obstacles such as the human body or a computer monitor can cause severe shadowing in mm-wave radio links. Specific models have therefore been developed to model for instance the static and dynamic characteristics of human-blockage [64].

A number of Hata-like path-loss models for mm-wave frequencies based on sets of measurements have been proposed [13][41][75][76]. Instead of an extensive mm-wave measurement campaign, ray tracing simulations in downtown Ottawa have been used recently to derive a dual-slope path loss model for 28 GHz outdoor links [63]. This dual-slope characteristic is probably related to the lower degree of through-wall penetration and DMC of mm-wave frequencies with respect to UHF.

Half way between deterministic propagation models and statistical channel models are Geometric-Stochastic Channel Models (GSCM) already proposed for radio channel simulation at lower frequencies and standardised at the international level [77]-[79]. GSCM models can be thought of as simplified RT models where scatterers generating multipath are placed in the space around the radio terminals according to statistical spatial distribution rather than according to a deterministic environment description. Ray paths (or ray clusters) are then generated using simplified RT techniques to derive realistic realizations of the radio channel and its parameters for each environment class. Besides simplicity, the advantage over RT models is the non-site-specific nature of the results, whereas the main disadvantage is the lower accuracy and reliability of them.

Since the application of mm-wave transmission to multi-Gigabit wireless systems adopting massive MIMO and beamforming techniques is foreseen, multidimensional propagation models accounting for time and angle dispersion of the signal are especially important. Some of these have been developed within standardization bodies such as the statistical channel model IEEE 802.15 TG3c [80] and the IEEE 802.11ad GSCM model [81]. The latter is based on a mix of deterministic RT and measurement-based statistical modelling techniques and on the concept of multipath cluster [43]. The trend seems to be towards the introduction of deterministic elements into GSCM models to derive “map-based GSCM” models [82].

In terms of fully stochastic modelling, papers show apparent differences of ray-cluster properties at mm-wave compared to the legacy lower-frequency bands. The widely-used drop-based GSCMs such as the WINNER II [77], ITU-R M.2135 [78] and 3GPP TR25.996 [79] for mobile channel generation define that there are 20 sub-paths inside a cluster, while the measurements at 28 and 60 GHz show clearly smaller number of sub-paths, typically up to 10 [81],[83]-[85]. Furthermore, the assumption of equal sub-path power over the angles in the cluster clearly contradicts with measurements, leading to overestimation of multipath richness [76]. This difference is especially crucial when using electrically large antenna arrays at mm-wave since they can resolve sub-paths inside a cluster and hence are sensitive to the intra-cluster sub-path structure.

V. APPLICATIONS AND STANDARDIZATION PROSPECTS

Some standards for applications in the 60 GHz bands are already available such as IEEE 802.15 tg3c and 802.11ad [5] [6]. These include the use of large arrays at both link ends to implement beamforming and enhance throughput density in indoor high-speed internet access and cable replacement applications. Implementations of the 802.11ad are now available in different devices such as laptops and smartphones. This standard is a big step forward for mm-wave communication, but the current system is limited in link re-establishing speed, beam directivity and polarization. This results in a maximum data rate of 7 GBit/s.

Therefore the development and standardization process of next generation of 60 GHz wireless LAN systems (IEEE 802.11ay), which will include more sophisticated technologies to reach data rates of more than 40 GBit/s, has already started.

The use of massive arrays to implement beamforming schemes with very narrow beams (pencil-beamforming) is envisioned [86], although the commercial implementation of such techniques using low-cost technology poses relevant technological challenges for the future. Analog signal-processing will have to be used to keep costs and electrical power consumption within reasonable figures, but this option will reduce flexibility with respect to the digital signal processing option and will probably limit the size of feasible antenna arrays [87].

Current use of the mm-wave band also includes backhaul and collision avoidance radar [88][89]. Backhaul commercial products are available in both the E band (60-90 GHz) and in the V-band (40-75 GHz). Backhaul in the licensed band 71-76 GHz and 81-86 GHz provide Gigabit data rates between the core network and various cellular systems (2G, 3G and LTE) while backhaul equipment in the unlicensed band in the frequency range 57-66 GHz offers Gigabit data rates to small cells such as on a street lamp-post or roof tops for self-organizing networks. The high data rates are envisaged as key enablers of heterogeneous networks where numerous small cells need to pass their load down the line.

Another mm-wave frequency band of interest is the 30-40 GHz band currently being investigated for mobile access in cellular network [3]. The aim is to utilize the abundant spectrum available in this band for mobile communication to achieve high data rates to support immersive multimedia services for future 5G radio networks over short ranges between 200-300 m in dense urban environments with a long range overlay of regular cellular networks in the lower frequency bands, then finally to migrate to the stand-alone 5G cellular communication systems

To enable standardization of mm-waves for cellular network, propagation channel models are essential as it is necessary to demonstrate the feasibility of using these higher frequency bands for cellular applications with adaptive beam forming and high mobility. Measurements and channel modelling in these frequency bands are at an early stage with limited measurements and path loss models. To date ITU-R recommendations do not provide

appropriate channel models and an intensive measurement campaign with high resolution and angular information is needed. To enable future standardization, effort is needed into 5GPP and the ITU Study groups 3 and 5.

VI. CONCLUSION

The availability of unallocated spectrum in the mm-wave band and of novel transmission techniques making use of large antenna arrays offer an opportunity to provide high data rates to enable immersive user experiences currently unachievable from cellular radio networks. While commercial products are currently available for backhaul and internet access point to point links, the applications of these frequencies to cellular users presents a grand challenge due to the shadowing effects and the need for adaptive beam forming in a high mobility environment. Therefore Gigabit data transmission in these bands requires accurate channel models with high-end channel sounders to provide angular spread and time delay characterization of the multipath components. In addition, path loss and shadowing effects will impact the data rate and there is a need for extensive measurements to obtain full radio propagation characterization.

Due to the limited availability of measurement data, and of suitable channel models, especially for the frequency bands between 8 GHz and 90 GHz, a number of open issues still exist, as briefly listed below:

- (i) the actual frequency dependence of path loss
- (ii) path loss exponent models for LOS and NLOS
- (iii) multipath delay- and angular-spread modeling including clustering
- (iv) the actual ratio of Specular to Dense Multipath Component (DMC) and proper modelling of the latter
- (v) feasibility of massive-array beam forming, and its impact on multi-dimensional channel characteristics, including polarization
- (vi) dynamic channel models for adaptive beamforming solutions

These issues require the design of novel and powerful channel sounders with multiple bands, multiple antennas and high repetition rates allowing a double-directional characterization of the channel. Limited channel models are included in the current ITU-R recommendations especially in the higher frequency bands. The lack of channel models needs to be addressed by a collective effort to provide input into standardization bodies.

VII. ACKNOWLEDGEMENTS

The authors would like to thank the EU COST Action IC1004 which provided a forum that facilitated the collaboration in the preparation of this manuscript. channel sounder in the 60 GHz band at Durham University was funded under EPSRC project PATRICIAN EP/I00923X/1 and a follow on Impact Acceleration Account. Huawei Technologies Co. is supporting the mm-Wave research at Technische Universität Ilmenau. The research at Bologna University was supported by the Center for Industrial Research on Information and Communication Technologies (CIRI ICT) of the

University of Bologna. UPCT and Lille work was supported by MINECO, Spain (TEC2013-47360-C3-2-P), the Fonds Unique Interministeriel (FUI) under the project SOSPedro, France (F1412020-U), and the European FEDER funds.

REFERENCES

- [1] European Project ICT-317669-METIS, Deliverable D8.4 METIS final Project Report. April 2015. <https://www.metis2020.com/documents/deliverables/>
- [2] V. Jungnickel, K Manolakis, W. Zirwas, B. Panzner, V. Braun, M. Lossow, M. Sternad, R. Apelfröjd, T. Svensson, "The role of small cells, coordinated multipoint, and massive MIMO in 5G," IEEE Communications Magazine, Vol. 52, Issue 5 Pages: 44 – 51, 2014.
- [3] W. Roh, J.-Y. Seol, J. Park, B. Lee, J. Lee, Y. Kim, J. Cho, K. Cheun, and F. Aryanfar, "Millimeter-wave beamforming as an enabling technology for 5G cellular communications: theoretical feasibility and prototype results," IEEE Communications Magazine, vol. 52, no. 2, pp. 106–113, February 2014
- [4] The 5G Infrastructure Public Private Partnership <https://5g-ppp.eu/>
- [5] IEEE 802.11ad International Standard for Information technology--Telecommunications and information exchange between systems--Local and metropolitan area networks--Specific requirements--Part 11: Wireless LAN Medium Access Control (MAC) and Physical Layer (PHY) Specifications Amendment 3: Enhancements for Very High Throughput in the 60 GHz Band, March 2014. <http://www.ieee802.org/11/>
- [6] IEEE 802.15.3c International Standard for Information technology Telecommunications and information exchange between systems - Local and metropolitan area networks - Specific requirements. Part 15.3: Wireless Medium Access Control (MAC) and Physical Layer (PHY) Specifications for High Rate Wireless Personal Area Networks (WPANs), 2009, <http://www.ieee802.org/15/>
- [7] 5G PPP mmMAGIC project. <https://5g-mmmagic.eu>
- [8] M. R. Yuce (Editor), Ultra-Wideband and 60 GHz Communications for Biomedical Applications, Springer, 2014.
- [9] Jofre, L.; Romeu, J.; Capdevila, S.; Abril, J.; Nova, E.; Alonso, M., "The "challenging" world of Terahertz radiation and imaging," Antennas and Propagation (EUCAP), Proceedings of the 5th European Conference on, vol., no., pp.3470,3475, 11-15 April 2011
- [10] Alexis Paolo Garcia Ariza, Robert Müller, Frank Wollenschläger, Alexander Schulz, Mohamed Elkhoully, Yaoming Sun, Srdjan Glisic, Uwe Trautwein, Ralf Stephan, Jens Müller, Reiner S. Thomä, Fellow, Matthias A. Hein, "60 GHz ultrawideband polarimetric MIMO sensing for wireless multi-Gigabit and radar," IEEE Trans. On Antennas and Propagation, VOL. 61, NO. 4, APRIL 2013, pp 1631-1641.
- [11] RP-151306 Channel modelling for higher frequency bands, 69th 3GPP TSG RAN Meeting, September 14-16, Phoenix (USA);
- [12] S. Salous, A. Cheema and X. Raimundo, "Radio channel propagation measurements using a multiband agile chirp sounder," URSI GA 2014, Beijing.
- [13] T.S. Rappaport, R. Sun Shu, H.Z. Mayzus, Y. Azar, K. Wang, G.N. Wong, J.K. Schulz, M. Samimi, F. Gutierrez, "Millimeter wave mobile communications for 5G cellular: It will work!," IEEE Access. Vol.1, pp.335-349, 2013.

- [14] K. Haneda, "Channel models and beamforming at millimeter-wave frequency bands," *IEICE Transactions on Communications*, vol. E98-B, no. 5, pp. 755–772, May 2015.
- [15] T.S. Rappaport, E. Ben-Dor, J.N. Murdock, and Q. Yijun, "38 GHz and 60 GHz angle-dependent propagation for cellular & peer-to-peer wireless communications," *Proc. IEEE Int. Conf. Commun. (ICC 2012)*, pp.4568–4573, June 2012
- [16] T. S. Rappaport, G. R. MacCartney, M. K. Samimi and S. Sun, "Wideband millimeter-wave propagation measurements and channel models for future wireless communication system design," *IEEE Trans. Commun.*, vol.63, no.9, pp.3029–3056, Sep. 2015.
- [17] G. R. MacCartney, T. S. Rappaport, S. Sun and S. Deng, "Indoor office wideband millimeter-wave propagation measurements and channel models at 28 GHz and 73 GHz for ultra-dense 5G wireless networks," *IEEE Access*, in press.
- [18] M. Sasaki, W. Yamada, T. Sugiyama, M. Mizoguchi, and T. Imai, "Path loss characteristics at 800 MHz to 37 GHz in urban street microcell environment," in *Proc. 9th European Conf. Ant. Prop. (EuCAP2015)*, Lisbon, Portugal, Apr. 2015.
- [19] M. Samimi et al., "28 GHz angle of arrival and angle of departure analysis for outdoor cellular communications using steerable beam antennas in new york city," *Proc. 77th IEEE Veh. Technol. Conf. (VTC 2013-Spring)*, pp.1–6, June 2013
- [20] K. Haneda, "Channel models and beamforming at millimeter-wave frequency bands," *IEICE Transactions on Communications*, vol. E98-B, no. 5, pp. 755–772, May 2015
- [21] M.R. Akdeniz, Y. Liu, M. K. Samimi, S. Sun, S. Rangan, T. S. Rappaport and E. Erkip, "Millimeter wave channel modeling and cellular capacity evaluation," *IEEE J. Sel. A. Commun.*, no.6, pp.1164–1179, Sep. 2014.
- [22] V. Degli Esposti, F. Fuschini, E.M. Vitucci, M. Barbiroli, M. Zoli, L. Tian, X. Yin, D. Dupleich, R. Muller, C. Schneider, R.S. Thoma, Ray-Tracing-Based mm-Wave Beamforming Assessment, *IEEE Access*, vol. 1, pp. 1314-1325, November 2014
- [23] International Telecommunication Union, "Propagation data and prediction methods for the planning of indoor radiocommunication systems and radio local area networks in the frequency range 900 MHz to 100 GHz," Recommendation ITU-R P.1238-8, July 2015.
- [24] L. M. Correia, P. O. França, "Estimation of materials characteristics from power measurements at 60 GHz," *IEEE International Symposium on Personal, Indoor, Mobile Radio Communications*, pp. 510–513, Sep. 1994.
- [25] J. Lu, D. Steinbach, P. Cabrol, P. Pietraski and R. V. Pragada, "Propagation characterization of an office building in the 60 GHz band," *8th European Conference on Antennas and Propagation (EuCAP 2014)*, The Hague, The Netherlands, 6-11 April 2014.
- [26] Cuinas, I.; Pugliese, J.-P.; Hammoudeh, A.; Sanchez, M.G., "Comparison of the electromagnetic properties of building materials at 5.8 GHz and 62.4 GHz," *Vehicular Technology Conference, 2000. IEEE 52nd VTS Fall*, vol.2, no., pp.780,785 vol.2, 2000.
- [27] F. Fuschini, S. Hafner, M. Zoli, R. Muller, E.M. Vitucci, D. Dupleich, M. Barbiroli, J. Luo, E. Schulz, V. Degli Esposti, R.S. Thoma, Item Level Characterization of mm-wave Indoor Propagation, *Eurasip Journal on Wireless Communications and Networking*, Accepted for publication, Sept. 2015
- [28] S. Salous, *Radio Propagation and Channel Modeling*, Wiley, 2013
- [29] G. Riva, V. Degli-Esposti, E. De Ponti, L. Ferrucci, E. Papa, "Characterization of mm-wave indoor propagation with directive antennas," *27th IEEE European Microwave Conference*, Jerusalem, Israel, September 8-12, 1997
- [30] K. C. Allen, Building penetration loss measurements at 900 MHz, 11.4 GHz, and 28.8 MHz, NTIA Report, U.S. Dept. of Commerce, National Telecommunications and Information Administration, (microfiche, Shipping list no.: 94-0659-M) 1994.
- [31] V. Degli-Esposti, F. Fuschini, E. M. Vitucci, M. Barbiroli, M. Zoli, D. Dupleich, R. Müller, C. Schneider, and R. S. Thomä, "Polarimetric Analysis of mm-Wave Propagation for Advanced Beamforming Applications," *9th European Conference on Antennas and Propagation (EuCAP 2015)*, Lisbon, Portugal, April 12-17, 2015
- [32] P. Beckmann and A. Spizzichino, *The Scattering of Electromagnetic Waves From Rough Surfaces*. Oxford, U.K.: Pergamon, 1963
- [33] A. Richter, "Estimation of radio channel parameters: Models and algorithms," Ph.D. dissertation, Technische Universität Ilmenau, Fakultät für Elektrotechnik und Informationstechnik, Ilmenau, DE, 2005.
- [33] D. Dupleich, F. Fuschini, R. Mueller, E. Vitucci, C. Schneider, V. Degli Esposti and R. Thomä, "Directional characterization of the 60 GHz indoor-office channel," *31th URSI General Assembly and Scientific Symposium*, Beijing, China, 16-23 August, 2014
- [34] K. Haneda, J. Järveläinen, A. Karttunen, M. Kyro, J. Putkonen, "A statistical spatio-temporal radio channel model for large indoor environments at 60 and 70 GHz," *IEEE Trans. Ant. Prop.*, vol. 63, no. 6, pp. 2694-2704, June 2015
- [35] K. Haneda, C. Gustafson and S. Wyne, "60 GHz spatial transmission: beamforming or multiplexing?," *IEEE Trans. Ant. Prop.*, vol. 61, no. 11, pp. 5735-5743, Nov. 2013.
- [36] S. Ranvier, J. Kivinen, P. Vainikainen, "Millimeter-Wave MIMO Radio Channel Sounder," *IEEE Transactions on Instrumentation and Measurement*, Volume: 56, Issue: 3, Pages: 1018 – 1024, June 2007
- [37] T. S. Rappaport, G. R. MacCartney, M. K. Samimi, S. Shu "Wideband Millimeter-Wave Propagation Measurements and Channel Models for Future Wireless Communication System Design," *IEEE Transactions on Communications*, Volume: 63, Issue: 9, Pages: 3029 – 3056, Sept. 2015.
- [38] Salous, Gao Wideband Measurements in Indoor and Outdoor Environments in the 30 GHz and 60 GHz Bands accepted for publication in *EUCAP 2016*
- [39] T. Zwick, D. Hampicke, A. Richter, G. Sommerkorn, R. Thomä and W. Wiesbeck, "A Novel Antenna Concept for Double-Directional Channel Measurements," *IEEE Trans. on VT*, vol. 53, No. 2, March 2004, pp.527-537.
- [40] M. Abdallah, S.M. Feeney, S. Salous and R. Lewenz, "Design and calibration of circular uniform beam array for wideband channel characterisation," *IET Proceedings, Microwaves, Antennas and Propagation*, vol 4, Issue 1, pp 43-53, January 2010.
- [41] S. Hur, Y. Cho, K. Lee, J. Ko, and J. Park, "Millimeter-wave modeling based on Measurements in In-building and campus environments at 28 GHz," presented in the 10th COST IC1004 MC and Scientific Meeting, Aalborg, Denmark on May 26-28, 2014.
- [42] R. Müller, S. Häfner, D.A. Dupleich, R. Herrmann, C. Schneider, J. Luo, X. Lu, R.S. Thomä, "Ultra-Wideband Channel Sounder for Measurements at 70 GHz," *IEEE 81st Vehicular Technology Conference: VTC2015-Spring 11–14 May 2015*, Glasgow, Scotland

- [43] C. Gustafson, K. Haneda, S. Wyne, F. Tufvesson, "On mm-wave multipath clustering and channel modeling," *IEEE Transactions on Antennas and Propagation*, vol.62, no.3, pp.1445,1455, March 2014
- [44] M. Landmann, M. Käske, and R.S. Thomä, "Impact of Incomplete and Inaccurate Data Models on High Resolution Parameter Estimation in Multidimensional Channel Sounding," *IEEE Trans. on Antennas and Propagation*, vol. 60, no 2, February 2012, pp. 557-573
- [45] E. Tanghe, D. P. Gaillot, W. Joseph, M. Liénard, P. Degauque, and L. Martens, "Robustness of high-resolution channel parameter estimators in the presence of dense multipath components," *IET Electron. Lett.*, vol. 48, no. 2, pp. 130–132, Jan. 2012.
- [46] M-T Martinez-Ingles, D.P. Gaillot, J. Pascual-Garcia, J. M. Molina-Garcia-Pardo, M. Liénard, and J. V. Rodriguez, "Deterministic and Experimental Indoor mmW Channel Modeling," *IEEE Antennas and Wireless Propagation Letters*, vol. 13, pp. 1047-1050, 2014.
- [47] Maria-Teresa Martinez-Ingles, Davy P. Gaillot, Juan Pascual-Garcia, Jose-Maria Molina-Garcia-Pardo, José-Víctor, Rodríguez, Lorenzo Rubio and Leandro Juan-Llácer, "Channel Sounding and Indoor Radio Channel Characteristics in the W-band, *EURASIP Journal on Wireless Communications and Networking*.
- [48] J. Medbo, M. Riback, H. Asplund and J. E. Berg, "MIMO channel characteristics in a small macrocell measured at 5.25 GHz and 200 MHz bandwidth," in *Proc. 62nd IEEE Veh. Tech. Conf. (VTC-2005-Fall)*, vol. 1, no., pp. 372-376, Sep., 2005.
- [49] K. Haneda, S. L. H. Nguyen and J. Jarvelainen, "Estimating omni-directional pathloss from directional channel sounding," 10th European Conf. Ant. Prop. (EuCAP 2016), Davos, Switzerland, submitted.
- [50] R. Müller, S. Häfner, D.A. Dupleich, R. Herrmann, C. Schneider, J. Luo, X. Lu, R.S. Thomä, "Ultra-Wideband Channel Sounder for Measurements at 70 GHz," *IEEE 81st Vehicular Technology Conference: VTC2015-Spring 11–14 May 2015, Glasgow, Scotland*
- [51] S. Salous, S.M. Feeney, X. Raimundo and A.A. Cheema, "Wideband MIMO channel sounder for radio measurements in the 60 GHz band," 2015, accepted for publication in the *IEEE Transaction on Wireless Communications*.
- [52] S. Salous, P. Filippidis, R. Lewenz, I. Hawking, N. Razavi-Ghods, and M. Abdallah, "Parallel Receiver Channel Sounder for Spatial and MIMO Characterisation of the Mobile Radio Channel," *IEE Proceedings on Communication*, vol. 152 (6), pp. 912-918, December 2005.
- [53] R. Zetik, M. Kmec, J. Sachs R.S. Thomä, "Real-Time MIMO Channel Sounder for Emulation of Distributed Ultra-Wideband Systems," *International Journal of Antennas and Propagation*, Hindawi Publishing Corporation, Volume 2014 (2014), Article ID 317683, 16 pages, <http://www.hindawi.com/journals/ijap/2014/317683/>
- [54] Thomas Zwick, Troy J. Beukema, and Haewoon Nam, "Wideband channel sounder with measurements and model for the 60 GHz indoor radio channel," *IEEE Trans. On Vehicular Technology*, VOL. 54, NO. 4, July 2005, pp 1266-1277.
- [55] <https://mentor.ieee.org/802.11/dcn/15/11-15-0879-03-00ay-channel-sounding-for-802-11ay.pptx>
- [56] R. Thomä, D. Hampicke, A. Richter, A. Schneider, G. Sommerkorn, U. Trautwein and W. Wirmitzer, "Identification of Time-Variant Directional Mobile Radio Channels," *IEEE Trans. on IM*, vol. 49, no. 2, April 2000, pp. 357-364.
- [57] <https://mentor.ieee.org/802.11/dcn/15/11-15-0840-01-00ay-nist-preliminary-channel-measurements-at-83-ghz.pptx>
- [58] J. Lu, D. Steinbach, P. Cabrol, P. Pietraski, R.V. Pragada, "Propagation Characterization of an Office Building in the 60 GHz Band", 8th Eur. Conf. Antennas Propag. (EuCAP'14), The Hague (NL), April 2014, pp. 809-813;
- [59] I. Cuinas, J.P. Pugliese, A. Hammoudeh, M.G. Sanchez, "Comparison of the Electromagnetic Properties of Building Materials at 5.8 GHz and 62.4 GHz", 52nd Veh. Tech. Conf. (VTC Fall'00), Boston (MA), September 2000, vol. 2, pp. 780-785;
- [60] L.M. Correia, P.O. Frances, "Transmission and isolation of signals in buildings at 60 GHz", 6th Int. Symposium on Personal, Indoor and Mobile Radio Communications (PIMRC'95), Toronto (CDN), September 1995, vol. 3, pp. 1031-1034;
- [61] D. Ferreira, I. Cuinas, R.F.S. Caldeirinha, T.R. Fernandes, "A Review on the Electromagnetic Characterization of Building Materials at Micro- and Millimetre Wave Frequencies", 8th Eur. Conf. Antennas Propag. (EuCAP'14), The Hague (NL), April 2014, pp. 145-149;
- [62] K.A. Korolev, M.N. Afsar, "Complex Dielectric Permittivity Measurements of Materials in Millimeter Waves", *Joint 30th Int. Conf. on Infrared and Millimeter Waves and 13th Int. Conf. on THz Electronics (IRMMW-THz 2005)*, Williamsburg (VA), September 2005 pp. 62-63
- [63] Y. Chang, S. Baek, S. Hur, Y. Mok, and Y. Lee, "A Novel two-slope mmWave channel model based on 3D ray-tracing in urban environments," *PIMRC 2014, Washington DC, USA, September 2-5, 2014*.
- [64] M. Jacob, S. Priebe, T. Kurner, M. Peter, M. Wisotzki, R. Felbecker, and W. Keusgen, "Extension and validation of the IEEE 802.11ad 60 GHz human blockage model," *EuCAP 2013, Gothenburg, Sweden, Apr. 8–12, 2013*.
- [65] W. Peter, W. Keusgen, and R. Felbecker, "Measurement and ray-tracing simulation of the 60 GHz indoor broadband channel: Model accuracy and parameterization," *EuCAP 2007, Edinburgh, UK, November 2007*
- [66] A. Karttunen, J. Jarvelainen, A. Khatun and K. Haneda, "Radio propagation measurements and WINNER II parametrization for a shopping mall at 61-65 GHz," 81st Veh. Tech. Conf. (VTC2015-Spring), Glasgow, Scotland, May 2015
- [67] J. Pascual-García, M. T. Matínez-Inglés, J. M. Molina-García-Pardo, J. V. Rodríguez, L. Juan-Llácer, "Using tuned diffuse scattering parameters in ray tracing channel modeling," in *Proc. 9th European Conference on Antennas and Propagation (EuCAP)*, Lisbon, Portugal, 13-17 April 2015.
- [68] S. L. H. Nguyen, K. Haneda, J. Jarvelainen, A. Karttunen and J. Putkonen, "On the mutual orthogonality of millimeter-wave massive MIMO channels," 81st Vehicular Technology Conference (VTC2015-Spring), Glasgow, Scotland, May 2015.
- [69] V. Degli-Esposti, F. Fuschini, E. Vitucci, G. Falciasacca, "Measurement and modeling of scattering from buildings", *IEEE Transactions on Antennas and Propagation*, Vol. 55 No 1, pp. 143-153, January 2007
- [70] J. Järveläinen, V. Degli-Esposti, K. Haneda, E. M. Vitucci, and C. Gustafson, "Modeling polarimetric properties in 60 GHz full-scattering propagation prediction method," 8th IC1004 MC and Scientific Meeting, Ghent, Belgium on September 26-27, 2013.
- [71] L. Raschkowski, P. Kyösti, K. Kusume and T. Jämsä (ed.), "METIS Channel Models," *ICT-317669-METIS*,

- <https://www.metis2020.com/documents/deliverables/>, Feb. 2015.
- [72] U.-T. Virk, J.-F. Wagen and K. Haneda, "Simulating specular reflections for point cloud geometrical database of the environment," 2015 Loughborough Antennas & Propagation Conference, Loughborough University, UK, 2-3 November 2015.
- [73] T. Pedersen, G. Steinbock, and B. Fleury, "Modeling of reverberant radio channels using propagation graphs," *Antennas and Propagation, IEEE Transactions on*, vol. 60, no. 12, pp. 5978–5988, 2012.
- [74] L. Tian, V. Degli-Esposti, E. M. Vitucci, X. Yin, S. X. Lu, F. Mani, "Deterministic modeling of diffuse scattering component based on propagation graph theory," PIMRC 2014, Washington DC, USA, September 2-5, 2014.
- [75] S. Piersanti, L. A. Annoni, D. Cassioli, "Millimeter waves channel measurements and path loss models," *IEEE International Conference on Communications (ICC) 2012*, Ottawa, Canada, 10-15 June 2012.
- [76] M. Kyro, K. Haneda, J. Simola, K. Takizawa, H. Hagiwara, and P. Vainikainen, "Statistical channel models for 60 GHz radio propagation in hospital environments," *IEEE Transactions on Antennas and Propagation*, vol. 60, no. 3, pp. 1569-1577, March 2012
- [77] P. Kyosti et al., "IST-4-027756 WINNER II, D1.1.2 V1.2, WINNER II Channel Models," in <http://projects.celticinitiative.org/winner+/deliverables.html>, 2008.
- [78] International Telecommunication Union, "Guidelines for evaluation of radio interface technologies for IMT-Advanced," Report ITU-R M.2135-1, Dec. 2009.
- [79] 3GPP TR 25.996, "Spatial channel model for multiple input multiple output (MIMO) simulations," Dec. 2009. [Online]. Available: <http://www.3gpp.org/DynaReport/25996.htm>
- [80] S.-K. Yong, "TG3c channel modeling sub-committee final report," *IEEE Tech. Rep.* 802.15-07-0584-01-003c, March 2007.
- [81] A. Maltsev, R. Maslennikov, A. Sevastyanov, A. Lomayev, and A. Khoryaev, "Statistical channel model for 60 GHz WLAN systems in conference room environment," *EUCAP 2010*, Spain, April 2010.
- [82] J. Medbo, K. Börner, K. Haneda, V. Hovinen, T. Imai, J. Järveläinen, T. Jamsa, A. Karttunen, K. Kusume, J. Kyröläinen, P. Kyösti, J. Meinilä, V. Nurmela, L. Raschkowski A. Roivainen, "Channel Modeling for the Fifth Generation Mobile Communications," *EuCAP 2014*, The Hague, The Netherlands, 6-11 April 2014.
- [83] S. Hur, Y.-J. Cho, T. Kim, J. Park, A.-F. Molisch, K. Haneda, and M. Peter, "Wideband spatial channel model in an urban cellular environments at 28 ghz," in *Proc. 9th European Conf. Antennas Propag. (EuCAP 2015)*, Lisbon, Portugal, Apr. 2015.
- [84] S. Hur, S. Beak, B. Kim, J. Park, A.-F. Molisch, K. Haneda, and M. Peter, "28 ghz channel modeling using 3d ray-tracing in urban environments," in *Proc. 9th European Conf. Antennas Propag. (EuCAP 2015)*, Lisbon, Portugal, Apr. 2015.
- [85] M.K. Samimi and T.S. Rappaport, "Ultra-wideband statistical channel model for non line of sight millimeter-wave urban channels," *Proc. IEEE Global Telecommun. Conf. (GLOBECOM 2014)*, Austin, TX, Dec. 2014.
- [86] T. Kim, J. Park, J.-Y. Seol, S. Jeong, J. Cho, and W. Roh, "Tens of Gbps Support with mmWave Beamforming Systems for Next Generation Communications," in *Proc. IEEE GLOBECOM, 2013*, pp. 3685–3690, Atlanta, GA, USA, 9-13 December, 2013
- [87] J. Liu, H. Minn and A. Gatherer (Editor), "The Death of 5G part 2: Will analog be the death of massive MIMO?," *IEEE ComSoc Technology News, CTN Issue: June 2015*. <http://www.comsoc.org/ctn/death-5g-part-2-will-analog-be-death-massive-mimo>
- [88] R. Taori, A. Sridharan, "In-band, point to multi-point, mm-Wave backhaul for 5G networks," *IEEE International Conference on Communications (ICC 2014)*, Pages: 96-101, Sydney, Australia, 10-14 June, 2014.
- [89] L. Song, S. Gigoyan, J. Wilson, A. E. Fathy, "Low Cost Antennas for Collision Avoidance Radar Sensors," *2007 IEEE Radio and Wireless Symposium*, pp. 257 – 260, Long Beach, CA, 9-11 Jan. 2007.