



# CPCOL

EUROPEAN JOURNAL OF  
CREATIVE PRACTICES  
IN CITIES AND LANDSCAPES

vol.3, n.1 2020  
ISSN 2612-0496

## **CURATING THE CITY: ARTISTIC PRACTICES AND URBAN TRANSFORMATIONS**

Edited by Annalisa Trentin,  
Anna Rosellini and Amir Djalali

Cristina Garzillo, Anastasia  
Gkoliomyti, Leila Haghighat, Susan  
Holden, Peter Klimczak, Alessandro  
Mosetti, Ashley Paine, Guillermo  
Ruiz de Teresa, Michele Smargiassi,  
Ke Sun, Yoshiharu Tsukamoto.





EUROPEAN JOURNAL OF  
CREATIVE PRACTICES  
IN CITIES AND LANDSCAPES

n.1 2020  
vol.3

ISSN 2612-0496  
<https://cpcl.unibo.it/>

## **CURATING THE CITY: ARTISTIC PRACTICES AND URBAN TRANSFORMATIONS**

Annalisa Trentin,  
Anna Rosellini,  
Amir Djalali,  
Anastasia Gkoliomyti,  
Yoshiharu Tsukamoto,  
Alessandro Mosetti,  
Guillermo Ruiz,  
Ke Sun,  
Leila Haghghat,  
Ashley Paine,  
Susan Holden,  
Cristina Garzillo,  
Peter Klimczak,  
Michele Smargiassi



EUROPEAN JOURNAL OF  
CREATIVE PRACTICES  
IN CITIES AND LANDSCAPES

n.1 2020  
vol.3

ISSN 2612-0496

<https://cpcl.unibo.it/>

<https://doi.org/10.6092/issn.2612-0496/v3-n1-2020>

**Editors-in-Chief**

**Carola Hein**, Delft University of Technology, Netherlands

**Giovanni Leoni**, University of Bologna, Italy

**Editors**

**Damiano Aliprandi**, Fitzcarraldo Foundation, Italy

**Micaela Antonucci**, University of Bologna, Italy

**Audrius Banaitis**, Vilnius Gediminas Technical University, Lithuania

**Andrea Boeri**, University of Bologna, Italy

**Alessandra Bonoli**, University of Bologna, Italy

**Vando Borghi**, University of Bologna, Italy

**Andrea Borsari**, University of Bologna, Italy

**Francesca Bruni**, City of Bologna, Italy

**Kelly Cotel**, ICLEI – Eurocities, Germany

**Gamze Dane**, Technical University Eindhoven, Netherlands

**Roberto Falanga**, University of Lisbon, Portugal

**Maria Felidou**, Athens School of Fine Arts, Greece

**Elisa Franzoni**, University of Bologna, Italy

**Cristina Garzillo**, ICLEI – Eurocities, Germany

**Jacopo Gaspari**, University of Bologna, Italy

**Valentina Gianfrate**, University of Bologna, Italy

**Giovanni Ginocchini**, Urban Center Bologna, Italy

**Julie Hervé**, Eurocities – ICLEI, Belgium

**Jyoti Hosagrahar**, UNESCO HQ, France

**Cécile Houpert**, Eurocities – ICLEI, Belgium

**Ana Ivanovska**, SS. Cyril and Methodius University of Skopje, Republic of North Macedonia

**Arturas Kaklauskas**, Vilnius Gediminas Technical University, Lithuania

**Raffaele Laudani**, University of Bologna, Italy

**Danila Longo**, University of Bologna, Italy

**Tino Mager**, Technical University Delft, Netherlands

**Gino Malacarne**, University of Bologna

**Ognen Marina**, SS. Cyril and Methodius University of Skopje, Republic of North Macedonia

**Joao Morais Mourato**, University of Lisbon, Portugal

**Valentina Orioli**, University of Bologna, Italy

**Panagiotis Pagkalos**, Athens School of Fine Arts, Greece

**Ana Pereira Roders**, Technical University Eindhoven, Netherlands

**Chiara Gemma Pussetti**, University of Lisbon, Portugal

**Ania Rok**, ICLEI – Eurocities, Germany

**Anna Rosellini**, University of Bologna, Italy

**Ines Tolic**, University of Bologna, Italy

**Corrado Topi**, University of York, United Kingdom

**Annalisa Trentin**, University of Bologna, Italy

**Michele Trimarchi**, Magna Graecia University, Catanzaro, Italy

**Wout van der Toorn Vrijhoff**, Technical University Delft, Netherlands

**Walter Vitali**, Urban@IT, Italy

**Managing Editor**

**Amir Djalali**, University of Bologna, Italy

**Martina Massari**, University of Bologna, Italy

**Federico Diodato**, University of Bologna, Italy

### Scientific Committee

**Manola Antonioli**, ENSA Paris La Villette, France  
**Pier Vittorio Aureli**, Architectural Association, United Kingdom  
**Alessandro Balducci**, Milan Polytechnic, Italy  
**Claudio Calvaresi**, Milan Polytechnic, Italy  
**Andrea Cavalletti**, University of Bologna, Italy  
**Neera Chandhoke**, Delhi University, India  
**Gregor Fitzl**, Potsdam University, Germany  
**Kalliopi Fouseki**, UCL London, United Kingdom  
**Elisa Giaccardi**, Technical University Delft, Netherlands  
**David Gissen**, California College of the Arts, United States  
**Torgim Guttormsen**, Norwegian Institute for Cultural Heritage, Norway  
**Bernadette Nadya Jaworsky**, Masaryk University, Brno, Czech Republic  
**Antonio Lucci**, Humboldt University, Germany  
**Thomas Macho**, Linz University of Art, Austria  
**Achille Mbembe**, University of the Witwatersrand, South Africa  
**Alain Milon**, University Paris Nanterre, France  
**Sarah Nuttall**, University of the Witwatersrand, South Africa  
**Vincent Nadin**, Technical University Delft, Netherlands  
**Joan Ockman**, University of Pennsylvania, United States  
**Agostino Petrillo**, Milan Polytechnic, Italy  
**Federico Rahola**, Genova University, Italy  
**Henrik Reeh**, Copenhagen University, Denmark  
**Hilde Remoy**, Technical University Delft, Netherlands  
**Kun Song**, Tianjin University, China  
**Teresa Stoppani**, London South Bank University, United Kingdom  
**Pieter Uyttenhove**, University of Gent, Belgium  
**Rashmi Varma**, Warwick University, United Kingdom

### Editorial Staff

**Stefano Ascari**, University of Bologna, Italy  
**Saveria Olga Murielle Boulanger**, University of Bologna, Italy  
**Matteo Cassani Simonetti**, University of Bologna, Italy  
**Ilaria Cattabriga**, University of Bologna, Italy  
**Lorenzo Ciccarelli**, University of Rome Tor Vergata, Italy  
**Antony Colclough**, EUROCITIES, Belgium  
**Felice Curci**, University of Bologna, Italy  
**Valentina Gianfrate**, University of Bologna, Italy  
**Beatrice Lampariello**, École Polytechnique Fédérale de Lausanne, Switzerland  
**María de las Nieves López Izquierdo**, University of Bologna, Italy  
**Viviana Lorenzo**, University of Bologna, Italy  
**Martina Massari**, University of Bologna, Italy  
**Sofia Nannini**, Politecnico di Torino, Italy  
**Gabriele Neri**, Accademia di architettura di Mendrisio, Università della Svizzera italiana, Italy  
**Leila Signorelli**, University of Bologna, Italy  
**Matteo Sintini**, University of Bologna, Italy  
**Yanchen Sun**, Tianjin University, China  
**Elena Vai**, University of Bologna, Italy  
**Francesco Volta**, City of Bologna, Italy  
**Kaiyi Zhu**, Technical University Delft, Netherlands

### Graphic Design

**Stefano Ascari**, University of Bologna, Italy  
**Maria Chiara Mazzoni**, University of Bologna, Italy

**RÖCK**



This project has received funding from the European Union's Horizon 2020 research and innovation programme under grant agreement No 730280.

**European Journal of Creative Practices in Cities and Landscapes (CPCL)** is scientific journal recognized by ANVUR (Italian National Agency for Evaluation of Universities and Research Institutes) for disciplinary areas 08 and 11. The Journal is indexed in the following databases and search engines: ANCP, BASE, Google Scholar, ROAD, Worldcat.



**EDITORIAL**

**Curating the City** .....1  
Annalisa Trentin, Anna Rossellini, Amir Djalali

**MAIN SECTION**

**Collections of the Present in the 20<sup>th</sup> Century and Beyond:  
Tokyo's Fieldwork and Guidebooks as Curatorial Practices** .....9  
Anastasia Gkoliomyti, Yoshiharu Tsukamoto

**Recognizing the Scenic Value of the City: Ephemeral  
Architecture as a Medium to Evoke Urban Memories** .....33  
Alessandro Mosetti

**Surrealist Curation:  
Urban Domesticity through the Surrealist Poetics of Analogy** .....53  
Ke Sun

**Hegemonic Struggles in the City: Artist-Run Spaces and Community Art in the  
Anti-Gentrification Movement** .....73  
Leila Haghighat

**Curating for Care in Mexican Chicago:  
How a Museum Gave Voice to a Migrant Community** .....95  
Guillermo Ruiz de Teresa

**Curating Architecture and the City: Recent Australian Pavilions** .....117  
Susan Holden, Ashley Paine

**PRACTICES**

**Artistic and Curatorial Power in Cities' Historic Spaces** .....139  
Cristina Garzillo

**MISCELLANEA**

**On the Practical and Theoretical Possibility of  
Exploiting Science Fiction for Urban Planning** .....149  
Peter Klimczak

**OPINION**

**Between Decay and Decorum:  
Photographers' Awareness of the Urban Scene** .....159  
Michele Smargiassi





CPCL

EUROPEAN JOURNAL OF  
CREATIVE PRACTICES  
IN CITIES AND LANDSCAPES

EDITORIAL

# Curating the City

**Annalisa Trentin** – University of Bologna (Italy) – Contact: [annalisa.trentin@unibo.it](mailto:annalisa.trentin@unibo.it)

**Anna Rosellini** – University of Bologna (Italy) – Contact: [anna.rosellini@unibo.it](mailto:anna.rosellini@unibo.it)

**Amir Djalali** – Xi'an Jiaotong-Liverpool University (China) – Contact: [amir.djalali@xjtlu.edu.cn](mailto:amir.djalali@xjtlu.edu.cn)

## ABSTRACT

Since the 1970s, exhibitions, museums and artistic events have gained a central role in shaping the transformation of the city. Art, culture and knowledge have become the instruments through which cities have faced the crisis of industrial economy and the rise of new paradigms and values of urban development, often hand-in-hand with processes of financial speculation and the intensification of social inequalities. Today, artistic practices, with their immediacy of means, their capacity to mobilize images and affects and their organisational structure, seem to have transformed the way in which cities are planned and built. What is the relation between art, artists and the city? How are artistic events transforming cities? Are curators the new architects and urban planners? Beyond the unmet promises of the “creative city,” can curatorial practices become forms of care for our cities?

## KEYWORDS

*Curation; Care; Architecture; Platform Urbanism; Exhibitions*

<https://doi.org/10.6092/issn.2612-0496/11961>

ISSN 2612-0496

Copyright © 2020 Annalisa Trentin, Anna Rosellini, Amir Djalali



If Shakespeare argued that the world is a stage and Rem Koolhaas argued that the world is a mall, today we must add that the world is an exhibition, and specifically, an architectural exhibition.

— Sylvia Lavin<sup>1</sup>

The curator has been described either as a care worker, or as a vampiric and despotic figure building their career on someone else's work. This dual nature can be illustrated in two episodes that marked the history of art in the postwar period.

The first is a three-page typewritten document written by New York artist Mierle Laderman Ukeles. The document is the *Maintenance Art Manifesto 1969! Proposal for an exhibition "CARE"*, in which Ukeles invented the role that she would maintain for the rest of her career: that of the maintenance artist. Maintenance is an activity dealing with what was left behind by the artistic avant-gardes and their obsession with constant innovation and development. Ukeles sees the necessity to constitute an aesthetic of maintenance and care as key elements for life, which should be inseparable from the destructive character of contemporary art: "after the revolution, who's going to pick up the garbage on Monday morning?"<sup>2</sup> Ukeles, who would later become the New York City Department of Sanitation's artist in residence, saw the work of taking care of the home and the city as a performative work of art, one which should be given visibility in the city's museum institutions.

Conversely, Harald Szeemann's catalogue for Documenta 5 (1972) was a 700-page folder, an ever-expanding archive of documents and traces accompanying what was considered the first example of a city-wide thematic artistic event.<sup>3</sup> Szeemann, previously known for his controversial exhibition *When Attitudes Become Form* at the Kunsthalle Bern in 1969, embodied the figure of modern curator as a powerful creative impresario, one able to capitalize upon artists' work, even by using their work beyond the artists' original intentions. This exhibition, in fact, was the first to feature the work of well-known artists not because of the intrinsic value of their artworks but because of their correspondence to the general topic of the exhibition. Furthermore, artworks were displayed alongside found objects such as comic books, political and commercial advertisements as well as artworks by mentally ill patients. Artists such as Richard Serra and Sol Lewitt, who took part in the exhibition, complained about their loss of artistic agency while working under Szeemann's supervision. In an open letter to *Artforum*, Robert Smithson famously compared the

---

1 Sylvia Lavin, "Showing Work," *Log*, no. 20 (2010): 5–10, <https://www.jstor.org/stable/41765360>.

2 Patricia C Phillips et al., *Mierle Laderman Ukeles: Maintenance Art* (Munich: Prestel, 2016).

3 Harald Szeemann and Documenta, *Documenta 5: Befragung der Realität. Bildwelten heute* (Kassel: Documenta, 1972).

role of the museum to an artistic confinement asylum, and that of the curator to a warden.<sup>4</sup> Ironically, Smithson's text was eventually swallowed up by Szeemann's catalogue-folder, further enriching the prestige of the institution and its curator.<sup>5</sup>

Despite the differences, in these examples the work of the artist-curator emerges, more or less literally, as a caretaker and manager of someone else's artistic work, regardless of its authorship status. As we saw, the already established artists did not welcome this "curatorial turn," as they were reluctant to accept limitations to their artistic freedom and autonomy, and the changing role of the artist in society. The curator, in Surrealist fashion, brings previously non-valued existing work into the museum space. At the same time, the exhibition emerges as a key element in the city, bringing the city's life into the museum, and at the same time diffusing the museum throughout the whole city.

According to the etymology, the curator is someone who takes care of something, traditionally a museum collection, caring of its preservation, its modes of display, and its dissemination. Progressively, with the birth of conceptual, performative, and relational art, curating had to deal more with the arrangement of site-specific events, spaces, artists, and institutions. The focus of the curator was not exclusively that of caring for physical artifacts, but caring for human, relational and affective material. As in the case exemplified by Ukeles's work, the role of the curator becomes that of an art institution's domestic and affective laborer. In this sense, the work of curating can literally be seen as a work of reproduction, insofar as we see reproduction as a peculiar form of production. Unlike what Marx believed, feminist critique in the 1970s showed that reproductive work, which was and still is performed mainly by women at home, is indeed a form of production, but it produces a very peculiar commodity—the labor force that was needed to be employed in the factories.<sup>6</sup> But what does curating as a form of reproductive labor produce in today's forms of production?

Today, curatorial work has become an activity which—consciously or not—pervades our whole productive life. Curating is the affective practice that allows us to ward off the anxiety caused by our over-exposition to sensory stimuli and information. Curating allows us to produce temporary horizons of sense by organizing contents upon which our shrinking attention spans might focus. In this sense, we perform curatorial tasks at all times: we decide how to get dressed for the day, what to eat and which products to buy—even reviewing them on online shopping *platforms*; we

---

4 Robert Smithson, "Cultural Confinement," *Artforum* 11, no. 2 (October 1972).

5 Philip Ursprung, "The Indispensable Catalogue," *Log*, no. 20 (2010): 99–103, <https://www.jstor.org/stable/41765377>.

6 Charlie Ponzio, "Performing Care Work: Maintenance/Reproduction Vs Development/Production and the 'Phantom' Caring Body," *NERO*, September 2020, <https://www.neroeditions.com/performing-care-work/>.

delete unwanted emails and “star” important ones; we take care of our digital personas and we point out what we “like” on social media; we edit our CVs by deciding which of our experiences should be in and which ones should stay out. Our capacity to select, categorize, sort, and connect content is a key element in the construction of artificial intelligence and machine learning, which feeds upon human’s own curatorial faculties. However, while everyone curates, only a few of us are getting paid to do so. In any case, becoming one’s own curator is a key element not only to becoming an Instagram influencer or an “entrepreneur of the self,” but simply to getting a job.<sup>7</sup>

At the same time, curating is act of management and an act of value extraction. Curators produce value from artworks and immaterial assets which they did not produce. By organizing and giving new visibility to artifacts and other immaterial assets, the curator is able to boost the reputation of an artist and their artworks. In this sense, the first modern curator is Marcel Duchamp. By placing a urinal in an art gallery, Duchamp was able to automate the production of artistic value, finally achieving the long-awaited liberation of the modern artist from craftsmanship and work.<sup>8</sup> But this process, initially viewed as a form of liberation of humans from their labor duties through direct self-valorization, was turned into a form of artistic mediation which often alienates the value of artistic creation from those who have produced it. The curator has been conceptualized as a parasitic figure, a vampire whose practice does not necessarily re-distribute the value produced by its original makers. This is often the case when the objects of curation are collectively produced cultural assets, such as underground art, traditional cultures, and immaterial cultural heritage. In this sense, the curator is a parasite who *extracts* value rather than producing it. For this reason, curatorial institutions such as museums and temporary events such as biennials and triennials can be seen as *platforms* for value extraction.<sup>9</sup> Can curating be seen as the paradigm of *platform urbanism*?<sup>10</sup>

As far back as 2009, Sarah Chaplin and Alexandra Stara saw the importance of curating not only as the specific activity of a professional specialized in the arts, but as a tool that could be employed by architects—as

---

7 David Balzer, *Curationism: How Curating Took over the Art World and Everything Else* (London: Pluto Press, 2015), <https://doi.org/10.1080/1472586x.2017.1320103>.

8 Maurizio Lazzarato, *Marcel Duchamp and the Refusal of Work* (Los Angeles: Semiotext(e), 2014).

9 On platforms, see Nick Srnicek, *Platform Capitalism* (Hoboken, NJ: John Wiley; Sons, 2017). For a theory of value extraction as a form of accumulation, see Verónica Gago and Sandro Mezzadra, “A Critique of the Extractive Operations of Capital: Toward an Expanded Concept of Extractivism,” *Rethinking Marxism* 29, no. 4 (October 2017): 574–91, <https://doi.org/10.1080/08935696.2017.1417087>.

10 On the recent debate around platform urbanism, see Sarah Barns, *Platform Urbanism: Negotiating Platform Ecosystems in Connected Cities* (London: Palgrave Macmillan, 2020), and Mike Hodson et al., *Urban Platforms and the Future City Transformations in Infrastructure, Governance, Knowledge and Everyday Life*. (Abingdon-on-Thames: Taylor & Francis Group, 2020), <https://doi.org/10.1007/978-981-32-9725-8>.

well as by all those figures responsible for shaping the built environment. “Approaching the city as a collection to be curated, whether through representations or *in situ*, opens up new possibilities for exploring and enriching the urban fabric and the urban condition as a whole.” On the city tour guide, at architectural exhibitions, and through heritage-based urban regeneration, they saw three examples in which curatorial practices can become tools not only to represent the city but also to actively transform it.<sup>11</sup> In the light of this intuition, this issue of CPCL explores the ambiguous nature of curatorial practices as both tools to care for the city in its physical and affective consistency, and as tools to extract value from history, local cultures, heritage, and labor. Contributions explore different ways through which curating becomes an effective way to produce the city and its space.

Tracing the development of a specific genre of inquiry on the city of Tokyo since the 1920s—the *fieldwork* and the *guidebooks*—Anastasia Gkoliomyti and Yoshiharu Tsukamoto explore the “collection of the present” as an agent of urban transformation. In these works, the city itself is seen from the estranged eye of the urban ethnographer documenting the demise and birth of new urban aesthetics and lifeforms within Japan’s modernization process. At the same time, these works have an implicitly prescriptive role in determining what artifacts and behaviors are to be maintained as elements in the construction of Tokyo’s new public spaces. The ethnographical study and the guidebook are curatorial acts which seek to develop a grammar of urban intervention from reality as found, coming across tools and languages in everyday life that provide alternatives to those of traditional urban planning.

Against the current practices of “urban regeneration,” in which the city’s memory is captured in the form of cultural heritage, Alessandro Mosetti proposes bringing back the age-old idea of architecture as a mnemonic device. Mosetti re-evaluates the work of architect Gian Carlo Leoncilli Massi in the context of the 1980 Venice Biennale, and in particular, within the exhibition *Venezia e lo spazio scenico* [Venice and the Scenic Space] (1979). The exhibition, staged as a series of temporary installations for the city of Venice as part of the Venice Biennale, was not an attempt to regenerate the city through an instrumental use of its heritage, but is interpreted here as a device deployed as an active tool for both the regeneration and the original construction of its collective memory. By bringing site-specific temporary uses and ephemeral architecture to the city, the exhibition constitutes a strategy that sets an example of how the architectural project could counter-act the impending musealization of the city of Venice.

Ke Sun approaches the construction of city through the production of dream images—“visual fantasies, corporeal kinesthesia, and alternative

---

11 Sarah Chaplin and Alexandra Stara, *Curating Architecture and the City* (London: Routledge, 2009).

narratives of reveries.” These are the product of the techniques that Sun calls the “Surrealist curation” of urban space, drawing on the construction of urban experiences based on assemblage and analogies, which transcend the physical datum of the city. The examples of Surrealist curation presented here—Le Corbusier Beistegui apartment in Paris (1929–1931) and Francis Alÿs’s *The Modern Procession* in New York City (2002)—constitute two examples where urban experience may be curated at the threshold between the public and the domestic sphere, the individual and the collective, the perceived and the imagined, countering the technocratic nature of data-driven urbanism.

Leila Haghighat explores the slippery role of artists and artistic institutions in lower-income neighborhoods. Artistic practices can be double-edged swords, in the sense that art can act as a tool to represent communities and make their inhabitants’ voices heard, but at the same time, their role as Trojan horses for urban regeneration and gentrification processes is well documented. Haghighat suggests politicizing the role of the urban community artist following Antonio Gramsci’s definition of the organic intellectual. In this way, the artist can become an active agent to transform the city into a battlefield against cultural hegemony, in which galleries and artistic institutions might serve as a tactical strongholds.

Museum institutions can indeed play a central role in neighborhoods, in particular with migrant and diasporic communities. This is the case of Chicago’s National Museum of Mexican Art, as Guillermo Ruiz claims. Through a first-hand participant observation from within the community, interviews and visual analysis, Ruiz shows how the museum became a reference point for the Mexican community in Chicago’s Pilsen neighborhood, providing an institutional voice to support their spatial justice claims through a “transnational practice of care.” According to the author, this example could become a replicable example showing a viable alternative to the abstractions exploited by policy makers.

In the final article, Susan Holden and Ashley Paine expose the urban pavilion as one of the central devices through which curatorial practices are being deployed today. Starting in London in 2000 under the initiative of curator Julia Peyton-Jones at the Serpentine Gallery, the modern cult of pavilions became global, and more galleries started adopting the Serpentine model for their own local programs. By analyzing the recent emergence of this phenomenon in Australia, the authors address the question of the politics of display and the current relation between curatorial practices, architecture, and the city.

The editors would like to thank those who anonymously reviewed the articles in this issue: Florencia Andreola, Fabio Ciavarella, Oren Eldar, Jacopo Galimberti, Ivano Gorzanelli, Beatrice Lampariello, Francesco Marullo, Cameron McEwan, Chiara Monterumisi, Elena Mucelli, Roberto Pasini, Stefania Rössl, and Raffaella Trocchianesi.

**Annalisa Trentin** is Full Professor in Architectural Design at the Department of Architecture, Alma Mater Studiorum, University of Bologna (Italy), Coordinator of the PhD program in Architecture and Design Cultures and Deputy Director of the Department of Architecture—University of Bologna, where she carries out research and teaching activities always looking at an innovative and interdisciplinary way of thinking pedagogy and university teaching. She is author of several articles and essays on architectural design, criticism and theory of architecture. Among her latest publications: *Bologna – Bogotá: research and action for public space* (2019); *Architettura e costruzione, la declinazione strutturale da Gustave Eiffel a OMA* (2016).

**Anna Rosellini** is Associate Professor at the University of Bologna since 2018, she carries out her research in the field of history of contemporary architecture. Her research interests are directed to architecture, from post-war period until today; to the relationship between architecture and art, and between form and matter. She has participated in national and international research projects and she collaborates with the École d'Architecture de la Ville & des Territoires of Paris-Est. Author of publications devoted to architecture and art of the post-war period, she has received a scholarship from the Fondation Le Corbusier in Paris.

**Amir Djalali** is Assistant Professor at the Department of Architecture, Xi'an Jiaotong-Liverpool University in Suzhou, China. He received his Master's in Architecture and Engineering from the University of Bologna, and his PhD at TU Delft. Previously, he taught theory seminars and design studios at the Berlage Institute, TU Delft, the Rotterdam Academy of Architecture and the University of Bologna and his essays appeared on international journals such as *Footprint*, *Volume* and the *Journal of Architecture*. Together with Hamed Khosravi and Francesco Marullo he published *Tehran: Life within walls* (Berlin: Hatje Cantz, 2017), a project on the politics of domestic space in the Iranian metropolis.

## References

- Balzer, David. *Curationism: How Curating Took over the Art World and Everything Else*. London: Pluto Press, 2015. <https://doi.org/10.1080/1472586x.2017.1320103>.
- Barns, Sarah. *Platform Urbanism: Negotiating Platform Ecosystems in Connected Cities*. London: Palgrave Macmillan, 2020.
- Chaplin, Sarah, and Alexandra Stara. *Curating Architecture and the City*. London: Routledge, 2009.
- Gago, Verónica, and Sandro Mezzadra. "A Critique of the Extractive Operations of Capital: Toward an Expanded Concept of Extractivism." *Rethinking Marxism* 29, no. 4 (October 2017): 574–91. <https://doi.org/10.1080/08935696.2017.1417087>.
- Hodson, Mike, Julia Kasmire, Andrew McMeekin, John G Stehlin, and Kevin Ward. *Urban Platforms and the Future City Transformations in Infrastructure, Governance, Knowledge and Everyday Life*. Abingdon-on-Thames: Taylor & Francis Group, 2020. <https://doi.org/10.1007/978-981-32-9725-8>.
- Lavin, Sylvia. "Showing Work." *Log*, no. 20 (2010): 5–10. <https://www.jstor.org/stable/41765360>.
- Lazzarato, Maurizio. *Marcel Duchamp and the Refusal of Work*. Los Angeles: Semiotext(e), 2014.
- Phillips, Patricia C, Tom Finkelpearl, Larissa Harris, Lucy R Lippard, Mierle Ukeles, and Queens Museum of Art. *Mierle Laderman Ukeles: Maintenance Art*. Munich: Prestel, 2016.
- Ponzio, Charlie. "Performing Care Work: Maintenance/Reproduction Vs Development/Production and the 'Phantom' Caring Body." *NERO*, September 2020. <https://www.neroeditions.com/performing-care-work/>.
- Smithson, Robert. "Cultural Confinement." *Artforum* 11, no. 2 (October 1972).
- Srnicek, Nick. *Platform Capitalism*. Hoboken, NJ: John Wiley; Sons, 2017.
- Szeemann, Harald, and Documenta. *Documenta 5: Befragung der Realität. Bildwelten heute*. Kassel: Documenta, 1972.
- Ursprung, Philip. "The Indispensable Catalogue." *Log*, no. 20 (2010): 99–103. <https://www.jstor.org/stable/41765377>.



## MAIN SECTION

# Collections of the Present in the 20<sup>th</sup> Century and Beyond: Tokyo's Fieldwork and Guidebooks as Curatorial Practices

Anastasia Gkoliomyti — Tokyo Institute of Technology (Japan) — Contact: [anastasia.gkoliomyti@gmail.com](mailto:anastasia.gkoliomyti@gmail.com)  
Yoshiharu Tsukamoto — Tokyo Institute of Technology (Japan), Atelier Bow-Wow — Contact: [tsukamot@arch.titech.ac.jp](mailto:tsukamot@arch.titech.ac.jp)

## ABSTRACT

Cities worldwide are transforming at an unprecedented speed. The technological advances of the 20th century have instilled significant transformations for urban centers around the world. In this context, the preservation of local communities is becoming a growing challenge for authorities worldwide. In times of such shifts for cities, the relationship between urban past, present, and future becomes a place of negotiation for academics and practitioners alike, with curatorial practices being at its center, creating a shift towards documentations of everyday ordinary life. Tokyo in particular, poses an exemplary case of urban transformations due to social, cultural, and economic restructuring that followed the opening of Japan's borders in 1868. As a result, fieldwork that took place in the 20th century and beyond evolved to be a vigorous practice that took different forms, aiming to "collect the present". These works can be retrospectively connected to discuss on notions of curation and interpretation of the city's transformation, and the role of the observer.

## KEYWORDS

*Curation; Tokyo; Fieldwork; Urban; Guidebook*

## PEER REVIEWED

<https://doi.org/10.6092/issn.2612-0496/10226>

ISSN 2612-0496

Copyright © 2020 Anastasia Gkoliomyti, Yoshiharu Tsukamoto

The technological advances of the 20th century instigated significant transformations in urban centers around the world. The fabric of metropolitan areas simultaneously expanded and densified, accumulating an excess of information, people and products. The increase in economic output and productivity resulting from technological development has also brought along unprecedented urban development and a drastic population increase, expecting to reach 8 billion people globally by 2026.<sup>1</sup> In times of such shifts in cities, curators are faced with the challenge of examining increasingly complex and disparate environments, as well as communities that are rarely homogeneous—where urban past, present and future become places of negotiation.<sup>2</sup> More and more authorities are acknowledging of the growing importance of “Contemporary Collecting” for curatorial practices,<sup>3</sup> where preserving local communities is seen as an essential step that will protect them from eradication amid the city’s rapid changing.

Long before the notion of “Contemporary Collecting” emerged in academic discourse, the urban context of early-20th century Tokyo had created fertile conditions for exo-museological “collections of the present”. Tokyo has experienced a continuous “metabolization”<sup>4</sup> ever since Japan underwent [rapid] social, cultural, and economic restructuring following the suspension of self-imposed autarky in 1868. Formerly named Edo and the feudal seat of government since 1603, Tokyo transformed into the nation’s modern-day capital in one generation. This metamorphosis was propelled by rapid changes in the economy, as well as by natural disasters and war.<sup>5</sup>

Activated by and with the purpose to document the transformations, the phenomenon of urban fieldwork books and guidebooks emerged in 1920s Tokyo and continues to this day, resulting in a multigenerational “relay race” of street observers. This study investigates this format of fieldwork and guidebook publications that appear following several paradigmatic events, arguing that they comprise a distinct mode of contemporary collecting of Tokyo’s changing urbanity. Authored by Japanese architects, designers and artists through the 20th century, the projects are assembled and cross-examined to map the representation of common topics across them, for example the commercial neighborhood of Ginza, street stalls typologies, fashion, city façade studies and more. Through

---

1 Michael Bhaskar, “Curation : The Power of Selection in a World of Excess,” 2016., 31.

2 “New museology movement of the 1980s”...and 1990s toward civic engagement (Cameron 2007).” In Wayne Golding, Modest Viv, *Museums and Communities Curators, Collections and Collaboration* (London: Bloomsbury Academic, 2013), <https://doi.org/10.1080/13527258.2013.870694>.

3 In Zvezdana Antoš, “Collecting’ the Present in Ethnographic Museums,” *Ethnological Research*, no. 18/19 (2013): 115-28.

4 Notion described in Koh Kitayama, Yoshiharu Tsukamoto, and Ryue Nishizawa, *Tokyo Metabolizing* (Tokyo: Toto, 2010), 10.

5 Namely, the 1923 Great Kanto Earthquake, the Oil Crisis of 1973, and the Economy Bubble Burst of 1992. Perhaps add: post-war economic development

**Timeline of Fieldworks and Guidebooks**

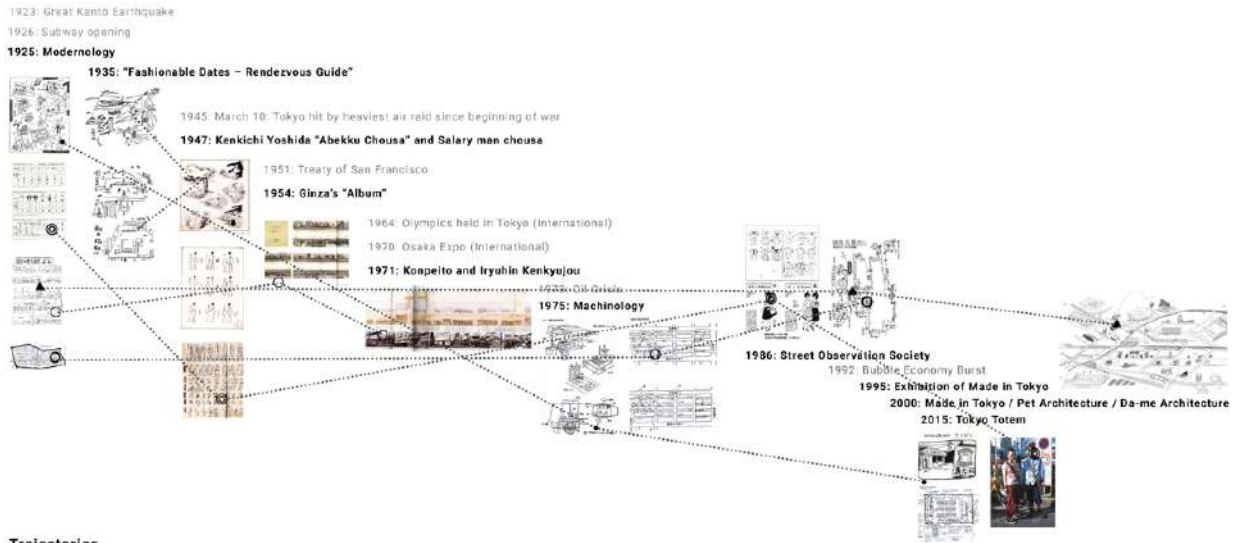

**Trajectories**

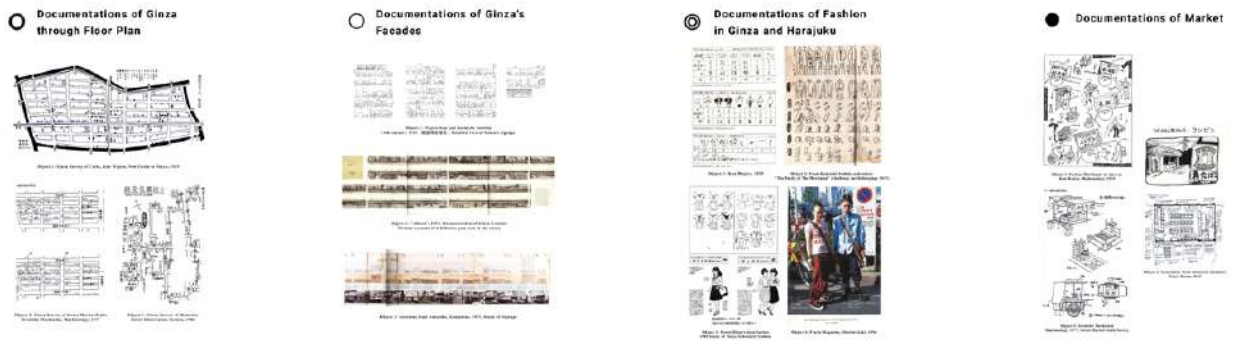

FIG. 1 Timeline of Fieldworks and Guidebooks and Trajectories of common themes across the cases.

employing the notion of “trajectory,” urban objects and representations are traced through distinct surveys that took place in different points of time, in order to piece together an ongoing, collective urban curation [Fig. 1].

Each of the selected cases had been created through the observation, documentation and reflection on the urban paradigm shifts its time, characterized by a preservationist attitude towards local communities, at risk of being lost amidst the metabolization of the city. Another common characteristic among the cases is their observation and documentation of the daily lives of ordinary peoples, and the way they continuously transform the city and create deviations from authorized planning. The self-positioning of these studies on the margins of the dominant urban discourse renders their authors as examples of “curators” who are active participants in the collections they produce. The historical and cross-cultural frameworks of the individual urban documentations of the present will illuminate aspects of the city previously not included in formal representations.

Urbanization and urban change until the 19th century relied on principles of formal design that evolved from authoritarian, structural, or symbolic prepositions.<sup>6</sup> The Renaissance practice of restoring a town after war

6 Joseph Rykwert, *The Idea of a Town: The Anthropology of Urban Form in Rome, Italy and the Ancient World* (MIT Press, 1988), 20.

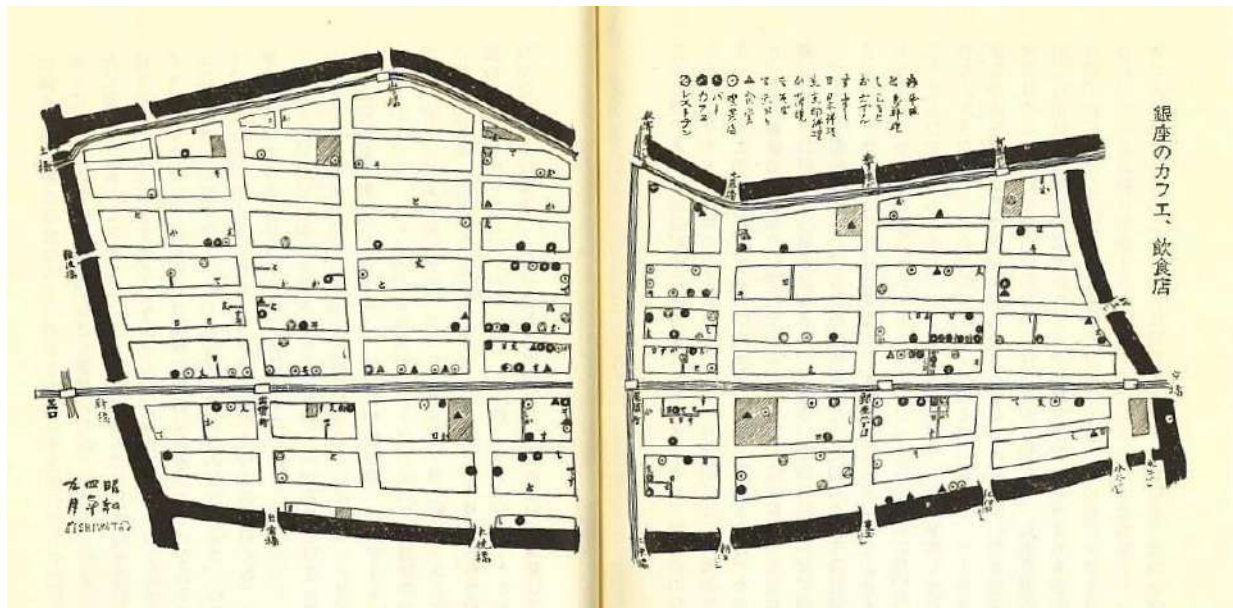

FIG. 2 Kon Wajiro, *Ginza's Cafés*, *New Guide to Tokyo*, 1929. (銀座のカフェ、新版大東京案内、1929).

or disaster served as a formal basis for conservation. Under this paradigm, significant events only moderately altered the city's image. On the contrary, cases of notable transformation emerged in the 19th century.<sup>7</sup> The reconfiguration of the agricultural town into the industrial, planned city, resulted in a new urban setting in a matter of decades. Planning paradigms in the 20th century have enabled a faster and unpredictable rhythm of urban transformations, owing to the emergence of industrial capitalist and liberal models, whereas more recent developments include the introduction of shared-interest planning.<sup>8</sup>

Along with the growth of cities, the necessity to acquire data on urban processes had already appeared by the mid-19th century. As urban planners Nuran Zeren Gülersoy and Ebru Gürler point out, "[p]lain-style urban plans became the base maps for the emerging science of urban statistics, through which expanding state capitals and new industrial cities were to be regulated."<sup>9</sup> Fieldwork was established as a method to collect data about urban space and to create comprehensive representations of urban phenomena with a primary aim of processing them as data. Guidebooks also served as an aid to navigate and make sense of the increasingly complicated city. The development of new technologies and infrastructures, and the imminent population transfer from an agrarian to urban contexts and lifestyles, coincided with a growing need for means of navigation in new and increasingly dense urban environments [Fig. 2].

7 Ibid.

8 Nuran Zeren Gülersoy and Ebru Gürler, "Conceptual Challenges on Urban Transformation," *ITU AIZ* 8, no. 1 (2011): 10-24.

9 Ibid., 54.

In Tokyo specifically, fieldwork evolved into a vigorous practice that took different forms ranging from “Design Surveys” to “Avant-Garde Surveys.”<sup>10</sup> As one of many new technologies that saw rapid implementation in Japan at the beginning of the 20th century, the explosive industrialization of printing resulted in the more effective circulation of these projects in printed formats such as magazine or book publications, demonstrating the power of such media and technologies as enablers of self-curation. These projects marked the appearance of the documentation of urban space and its transformation, while also including interpretations of what the change could mean for the communities involved.

In these early guides and projects, Tokyo was being likened to an incomprehensible maze, a city like nothing previously known. In this context, fieldwork became an integral tool for urban discourse, accommodating the increasing need for information on how to inhabit the new environment. Small books with practical knowledge such as statistical data, guidebooks, historical documents, descriptions of landmarks, restaurant suggestions, places for dating, cafes, etc. served as tools to help Tokyoites navigate the new urban condition. With the ability to select from an array of choices, fieldworks and guidebooks singled out certain urban features as important, while omitting other aspects not worthy of display. In this manner, these publications contributed to the creation of narratives and conceptual frameworks, comprising the selected items and the routes/pathways to reach them physically, or ideologically. This type of urban curation has the capacity to reinforce, react to, or rescue chosen elements within the city.

### **Urban curation as social/ethnographic construction: Modernology (1925)**

The origins of the phenomena of “Collections of the present” in Tokyo can be traced to Modernology (モデルノロジオ). Literally meaning the “study of modern things,” it was established by Wajiro Kon<sup>11</sup> and Kenkichi Yoshida<sup>12</sup> in 1925. What started as an exhibition in the newly opened branch of the Kinokuniya bookshop in the urban center of Shinjuku attracted the broad attention of scholars as well as the general public and was followed by publications in journals and books. Kon was an architect, a housing reformer, educator and scholar of daily life ethnography and customs of the inter-war period. He took part in fieldwork studies along with folklorist Kunio Yanagita,<sup>13</sup> researching the vernacular houses of the countryside (*minka*) between 1917-1922. Later on, he documented the way people’s livelihoods

---

10 As distinguished by Izumi Kuroishi, “Urban Survey and Planning in Twentieth-Century Japan: Wajiro Kon’s ‘Modernology’ and Its Descendants,” *Journal of Urban History* 42, no. 3 (2016): 557-81, <https://doi.org/10.1177/0096144216635151>.

11 今和次郎, Wajiro Kon (1888-1973)

12 吉田謙吉, Kenkichi Yoshida (1897-1982)

13 柳田國男, Kunio Yanagita (1875-1962)

changed on the aftermath of the 1923 Great Kanto Earthquake.<sup>14</sup> The occurrence of the earthquake devastated the capital and “brought a break in history, comparable to the one World War I brought to Europe and the United States.”<sup>15</sup> In the aftermath of the disaster over 44 percent of the urban area of Tokyo burned, and 73.8 percent of all households were affected in a substantial way.<sup>16</sup>

According to historian Miriam Silverberg, “[a]t this time ethnographers became interested in studying ruptures in social relationships through discourse preoccupied with mores and customs.”<sup>17</sup> To document this paradigm shift, Kon and Yoshida focused on fieldwork conducted in the commercial district of Ginza, with a goal to document the newly acquired lifestyles and customs that ensued as a result of the earthquake and rapid modernization. The new objects of modern life and the relationships between people and their surroundings were pivotal for Kon and Yoshida, and their way of looking at urban phenomena essentially introduced a notion of “street heritage.”<sup>18</sup> The pair together with students would go on to document and collect objects and details, ranging from “the signs drawn on pieces of scrap wood, to the kinds of clothes worn by people passing through the town.”<sup>19</sup> The result was a collection of modern artefacts, likened to the typical processes of archaeological expeditions, or “an archaeology of the present”. Unlike archaeologists, “modernologists” can exert a major influence on the city and the future of its inhabitants. As Kon articulates in the paper “The Psychological Foundation of City Planning” (1918):

City planning should be considered through observing the change of streets from the perspective of a so-called change of character, manners, and mentality, clarifying the underlying cause of transition stage of civilization, coping with the concentration of the urban population, and sociologically grasping an actual situation.<sup>20</sup> [Fig. 3]

---

14 Midday of September 1, 1923. The ensuing fire went on to destroy almost half of Tokyo with 140000 killed or missing.

15 Jun Tanaka in Hiroshima City Modern Museum, *Rojō to Kansatsu o Meguru Hyōgenshi: Kōgengaku No Genzai [Expressive History of Street and Observation: Kōgengaku's Present]* (Tokyo: Filmart, 2013), 46.

16 Yorifusa Ishida, “Ougai Mori and Tokyo’s Building Ordinance,” in *Tokyo: Urban Growth and Planning 1868-1988*, by Hiromichi Ishizuka and Yorifusa Ishida (Tokyo: Iwanami Shoten, 1988), 83-86.

André Sorensen, *The Making of Urban Japan: Cities and Planning from Edo to the 21st Century* (London: Routledge, 2002), 125.

17 Miriam Silverberg, “Constructing The Japanese Ethnography Of Modernity,” *The Journal of Asian Studies* 51, no. 1 (1992): 30-54. <https://doi.org/10.2307/2058346>.

18 Jun Tanaka in Hiroshima City Modern Museum, *Rojō to Kansatsu o Meguru Hyōgenshi: Kōgengaku No Genzai [Expressive History of Street and Observation: Kōgengaku's Present]*, 46.

19 Teronobu Fujimori, “Under the Banner of Street Observation,” in *Street Observation Studies Primer*, by Genpei Akasegawa, Teronobu Fujimori, and Shinbo Minami (Tokyo: Chikuma Shōbō, 1986), 6-22, <http://forty-five.com/papers/154>.

20 Kuroishi, “Urban Survey and Planning in Twentieth-Century Japan: Wajiro Kon’s ‘Modernology’ and Descendants,” 5.

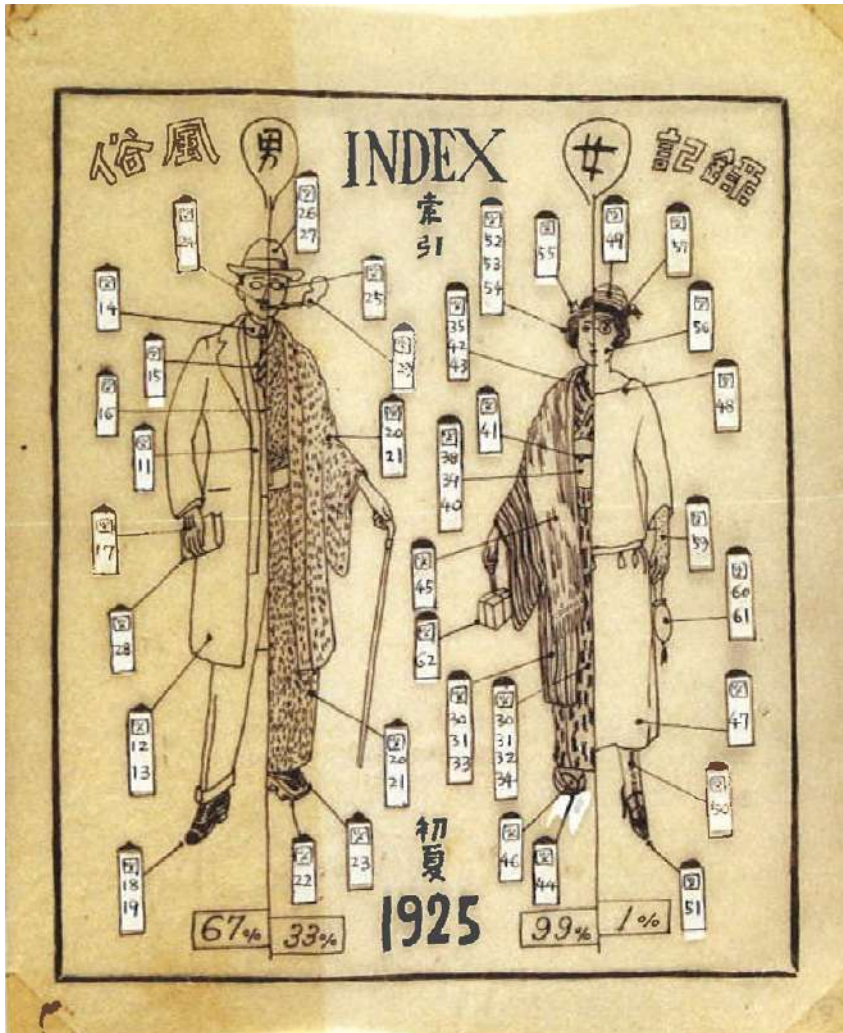

FIG. 3 Kon Wajiro, *Modernology*, observation of Ginza's fashion.

In *The New Guide to Tokyo*,<sup>21</sup> Kon claimed that it was the opening of Tokyo Station in 1915, rather than the devastating Kanto Earthquake, that effectively created new social and professional classes in Japan—groups of people that would meet and interact in the vast public spaces in Tokyo. Rather than conceptualizing society through the framework of “civilization,” the metaphor of “construction” appears to be the prevalent motif for describing the ethos of the post-earthquake, and subsequently the post-war, period. This notion of construction was not only limited to the establishment of the urban environment but also extended to the “construction of everyday social activities”.

The new approach to urban space in *Modernology* included, for the first time, the productive and material realm of the newly established middle-class, drawing parallels between their practices and their everyday objects in a manner typical to ethnographic studies. It also brought awareness to the transformation of the city's social ethos by emphasizing ways of life alongside physical urban settings. Through detailed accounts of material objects that locals used, the drawings of *Modernology* provided

21 Wajirō Kon, *New Guide to Tokyo (Shinpan Dai Tokyo Annai)* (Tokyo: Chuo Koronsha, 1929), 12.

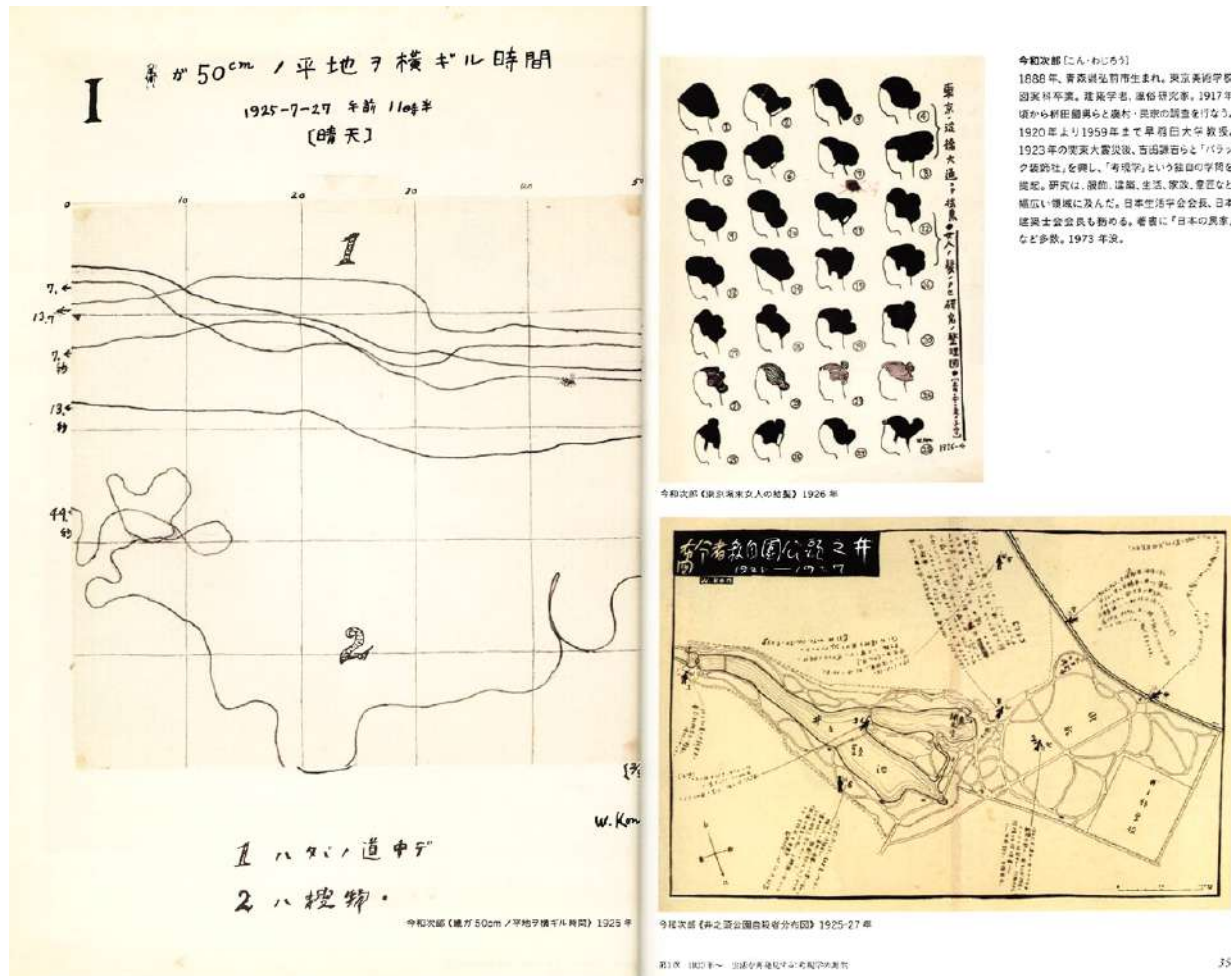

FIG. 4 Kon Wajiro, 1925-1927, Drawings of the movement of ants in a 50 cm space, female hairstyles, and fieldwork in Inokashira Park.

a sense of daily life in the particular settings studied. Such drawings range from westernized women's hairstyles, the movement of ants in a 50 cm space, drawings of city spaces, and many more [Fig. 4].

## Curating spatial expectations: "Abekku"<sup>22</sup> Rendezvous in Public space (1935)

Information on urban space in the early modern period was circulated in different formats to serve multiple roles: firstly, to embrace popular culture along with the new ways of interaction between men and women; and secondly, to advance a new bourgeois subjectivity of everyday life compatible with the modern economy. The formation of new social classes tied to the rapid industrialization of the nation also produced new audiences, and a concurrent search for new forms of entertainment serving them. Herein lies a notion of curation different from the "construction of

22 The French word "avec", meaning "together", was imported to Japanese to describe romantic dating.



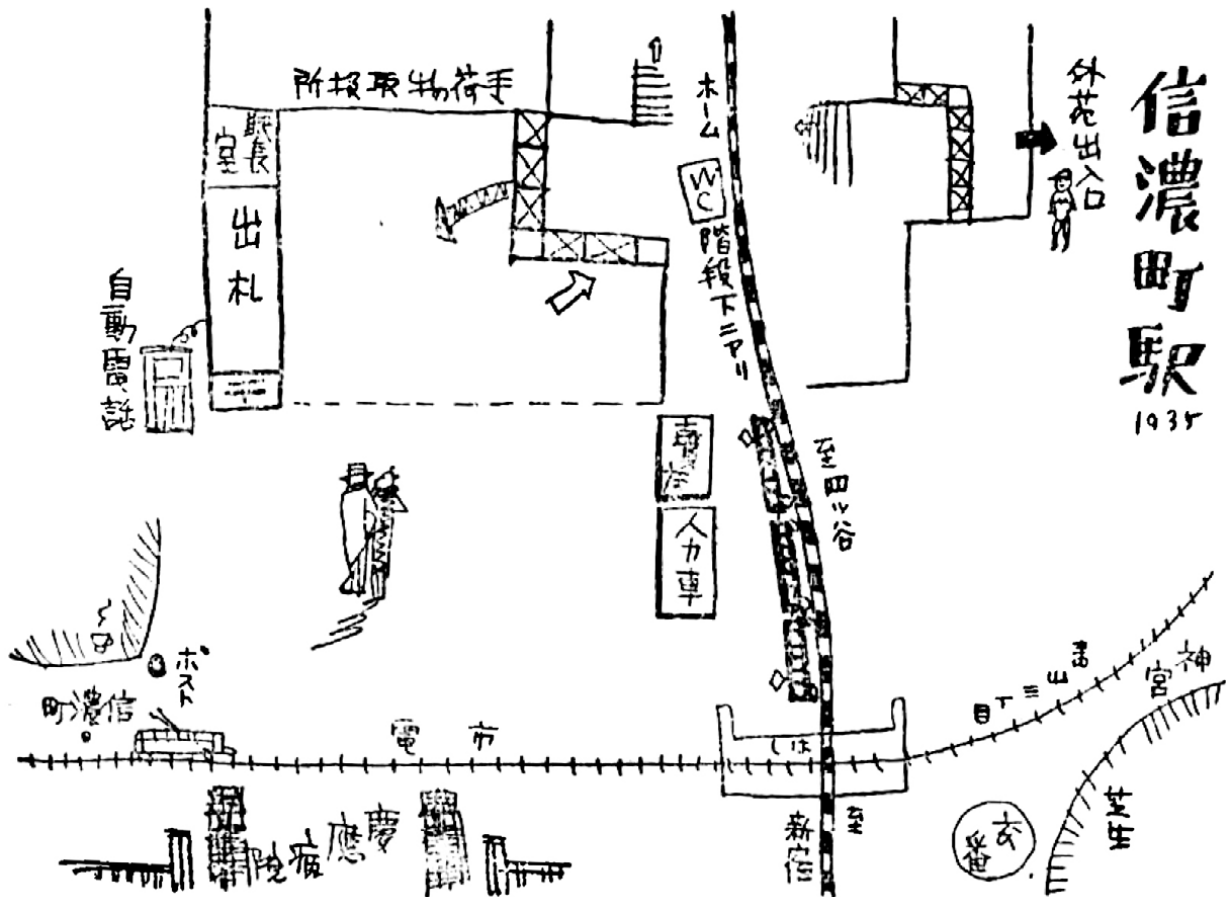

FIG. 5 Fashionable Dates – Rendezvous Guide, Meeting at Shinanomachi Station, 1935.

the everyday” seen in Modernology, that of urban behaviors reflecting the expectations instilled by printed media.<sup>23</sup>

If conventions expressed in guidebooks generated and standardized forms of information about the city, they also simultaneously described and prescribed modes of urban experience. In the Tokyo of the 1920s and 1930s, new ways of co-existing in the city were curated, and in turn, instigated, through printed materials such as guidebooks and magazines. The selective aggregation and ordering of spatial information—concerning its typology, density, order, and meaning—itself contributes to the production of spatial specificity and thus to the creation of expectation, resulting in new behaviors.

In the case of *“Fashionable Dates - Rendezvous Guide,”*<sup>24</sup> the act of romantic dating was mapped as an activity in urban space. Journalist Ogawa Takeshi created the guide to inform young couples on how to date in the city. He offered advice on how to use the city’s twelve most popular train stations of Tokyo by providing detailed descriptions of the spatial layouts and locations of these spots [Fig. 5], along with accounts of the types of people that frequented them. Ogawa describes thirty different dating

23 Here we can draw parallels to “Touristic Reflexivity... In John Urry,”1. *The Tourist Gaze*, *The Tourist Gaze*, 1990., 141-142.

24 Takeshi Ogawa, *Randebū No Annai: Ryusenkei Abekku [Rendezvous Guide: Fashionable Dates]* (Tokyo: Marunouchi shuppansha, 1935).

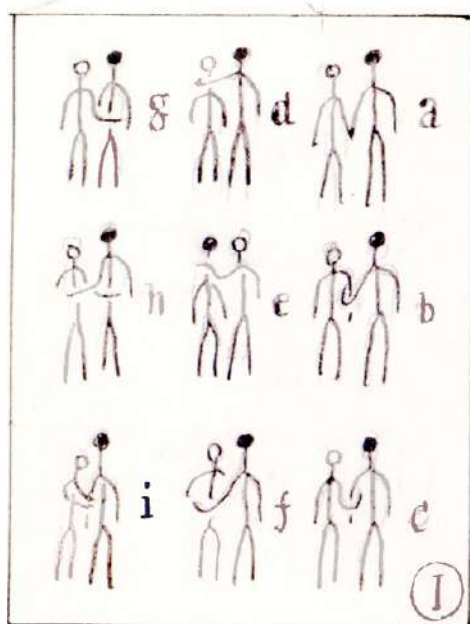

吉田誠吉 アベックの調査 1947年

FIG.6 Rendezvous Survey (Abekku Chousa), Kenkichi Yoshida, 1947.

samples, using scenarios, fake diary entries, hypothetical conversations, budget tables and more.

Introducing the activity of “dating” to a place has transformative power over it in the same sense that to describe experience in many cases can mean to prescribe experience. Guidebooks inherently engage in the latter activity, saving their audiences the mental work of decision by both deciphering the workings of the spatial environment and providing a framework for decision-making. These acts of taking the raw materials of the city and integrating them into a working image requires the identification of distinct objects and the events that will happen amongst them—an activity showing strong parallels to curation. By choosing what to highlight and what to ignore, the urban curator creates a feedback loop: describing the current uses of space, thus influencing people’s behavioural patterns; in turn leading to future curators describing them all over again [Fig. 6].

## Konpeitou<sup>25</sup>

In the late 1960s, students of the Department of Architecture at Tokyo University of the Arts formed the group “Konpeitou” (“star candy”) to investigate a commercial district of Tokyo called Ameyoko. Attempts were made to record all the phenomena, from alleys to shops, product displays, billboards and paperboards, soundscapes and so on. In doing so, the group was attempting to take an experiential perspective on the city, disregarding the viewpoint of the planner. Konpeitou published two special features in the magazine *Urban Housing* in 1971 under the title: “Ameyoko is a village in Tokyo.” The group members expressed particular interest in the

25 コンペイトウ・star-candy

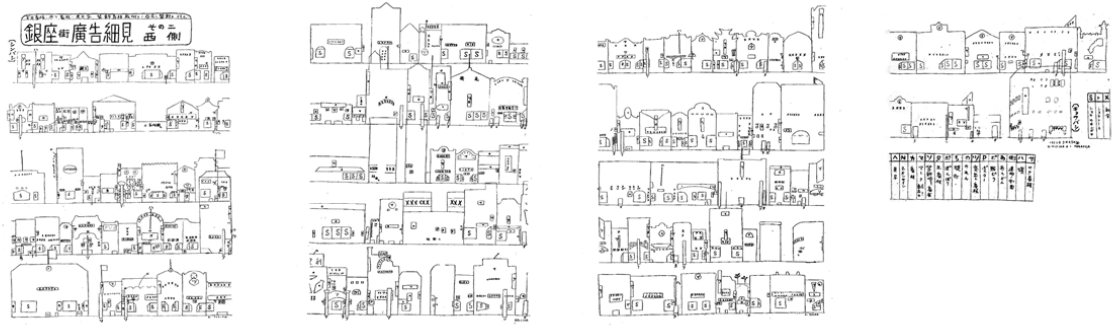

**Object 1: Wajiro Kon and Kenkichi Yoshida  
13th January 1931 - 銀座報告細見 – Detailed view of Ginza’s signage**

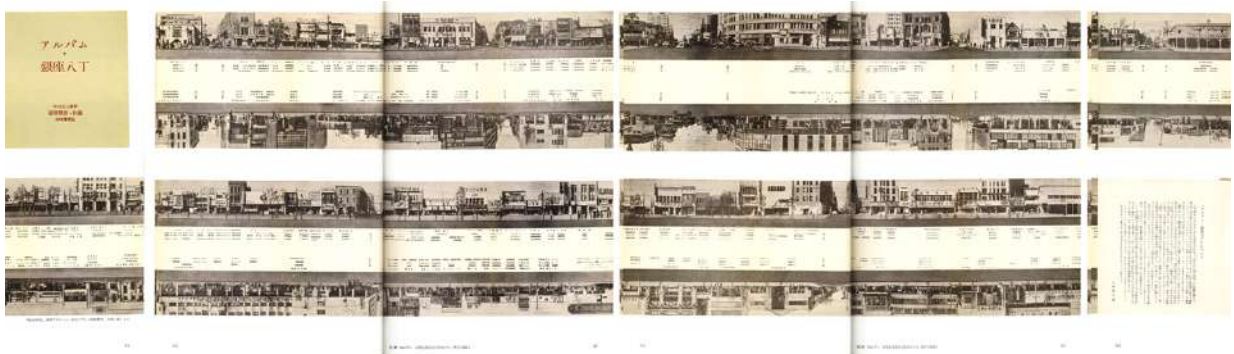

**Object 2: "Album", 1954. Documentation of Ginza 8-chome  
Written account of 4 different past uses in the street**



**Object 3: Learning from Ameyoko, Konpeitou, 1971, Study of Signage**

**FIG.7** Trajectory of Facade Studies, documented by different individuals 1931, 1954 and 1971

various decorations and posters found in the city. As Makoto Motokura, a member of Konpeitou claimed, “[i]t is possible to think that cities are made like collages or assemblages.”<sup>26</sup>

Konpeitou’s documentations of Ameyoko’s signs and posters resemble Kon Wajiro’s 1925 survey of Ginza’s signage. These two projects can be viewed vis-à-vis “Album,” a photographic documentation of the Ginza Hachome district back in 1954 by Kenkichi Yoshida, forming a constellation of urban observers [Fig. 7]. In the first two surveys Ginza is depicted on different premises, the documentation of signs on buildings in the

26 Hiroshima City Modern Museum, *Rojō to Kansatsu o Meguru Hyōgenshi: Kōgengaku No Genzai* [Expressive History of Street and Observation: Kōgengaku’s Present], 42.



Object 1: Various Merchants on the way  
Kon Wajiro, Modernology, 1925

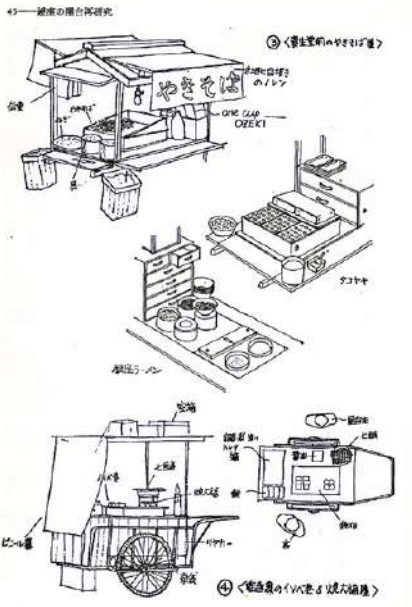

Object 2: Teruhiko Mochizuki  
Machinology, 1977, Street Market Stalls Survey

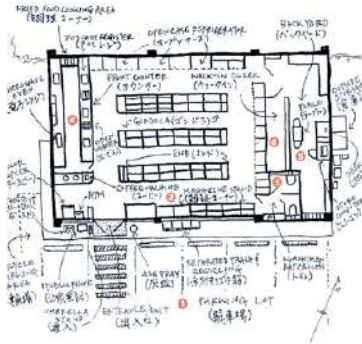

Object 3: "Konbini Morphology"  
Whitelaw, Gavin Hamilton. 2015.  
Convenience Store Research  
in Tokyo Totem: A Guide to Tokyo,  
Edwin Gardner and Christian Fruneaux,  
eds., Tokyo: Flick Studio,  
pp. 284-287. Tokyo Totem, 2015

FIG.8 Trajectory of Street Stalls and their replacement by convenience stores. Documentations by separate individuals in 1925, 1977 and 2015.

1930's, and the rapid change of uses through photographic accounts in the 1950's. A characteristic layout of street facades extending horizontally and vertically almost like sentences in a book is employed and is formally consistent in the account of Konpeitou in the 1970's.

In the following decade, yet more groups and individuals took to the streets to document their city. Among them were the Institute of Relics (Iryuhin Kenkyujou), and Machinology (Townology) by the architect Teruhiko Mochizuki in 1977. The latter undertaking was a survey focusing on street activities and temporary architecture such as *yatai* (market stalls). Mochizuki's aim was to instil discussion about the preservation of such structures, as in his view they provided valuable ways of building community in urban areas where relations between people were

not given but had to be built by communicating with each other. Such temporary and portable structures had also been documented by Kon Wajiro's *Modernology*. Wajiro and Mochizuki's fieldwork drawings form part of the broader trajectory of observations on the life of these mercantile objects, and their eventual extinction and replacement by the still dominant *konbini* or "convenience store" [Fig. 8].

### Collective curation of the marginal: Street Observation Society (1986)

Claiming to be descendants of *Modernology*, the "Street Observation Society" (Rojou Kansatsu Gakkai / 路上観察学会) was formed in 1986 by Tenpei Akasegawa (1937-), Terunobu Fujimori (1946-), Minami Shinbou (1947-) and others. Some of the individuals had been already active in documenting aspects of the city since the 1970s. For instance, Akasegawa catalogued utility holes and redundant objects such as stairs and doors leading nowhere, while Terunobu Fujimori founded a group in 1974 to study the Western-style buildings of Tokyo, called Tokyo Architecture Detective Agency. As historian Jordan Sand argues, the Street Observation Society's activities took "anti-monumentalism to the extreme" and eventually "...Street observation became a fad, spawning spin-off groups and imitations in youth oriented magazines and on television."<sup>27</sup> The group attracted widespread attention and was invited to publish in magazines and other media, as well as featured in a television program on rediscovering cultural resources in various parts of Japan. Their influence inspired local cities to form their own groups of observers of the streets [Fig. 9].



FIG.9 The founding of the Street Observation Society, 1986.

27 Jordan Sand, "Monumentalizing the Everyday: The Edo-Tokyo Museum," *Critical Asian Studies* 33, no. 3 (2001): 351-78, <https://doi.org/10.1080/14672710121867>.

7日午後4時25分-4時5分		西側南行 (歩行者を除く) KON					
206人							
北 (尾張町)	5	25	30	34	1	0	
南	2	16	28	56	8	1	
計	7	41	58	90	9	1	
%	3	20	29	44	4	(1/20)	

今般大群「東京銀座街観測記録」より(カラー) (図14) 1925年

9日午後1時55分-2時12分		西側北行 KON					
45人							
北 (尾張町)	0	4	3	1	3	3	0
南	0	17	2	2	5	5	0
計	0	21	5	3	8	8	0

今般大群「東京銀座街観測記録」より(モノクロ) (図20) 1925年

9日午後3時45分-4時15分		西側北行 KON					
59人							
北 (尾張町)	22	28	8	1	0	0	0
南	38	48	14				
計	60	76	22	1	0	0	0

0.3% 14人は化粧を施す者あり

今般大群「東京銀座街観測記録」より(白紙) (図56) 1925年

Object 1: Kon Wajiro, 1925

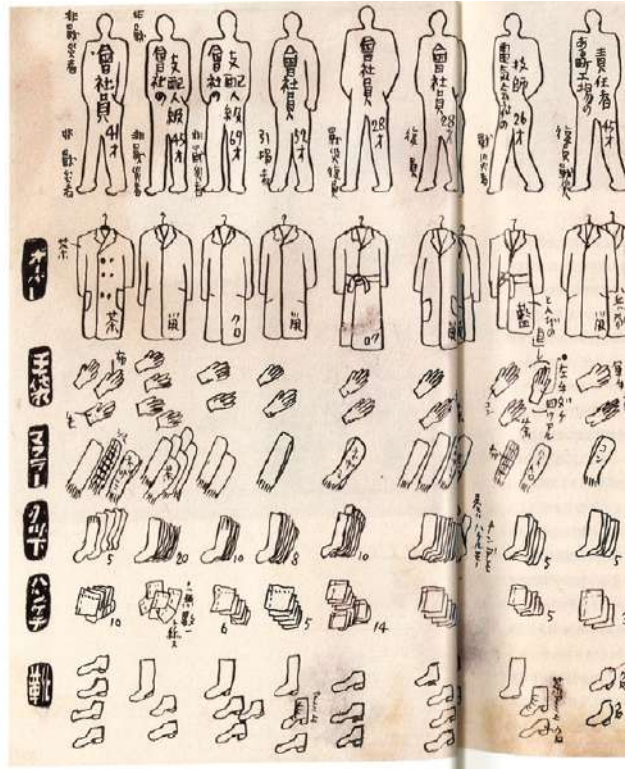

Object 2: From Kenkichi Yoshida and others "The Study of The Workman" (clothings and belongings 1947)

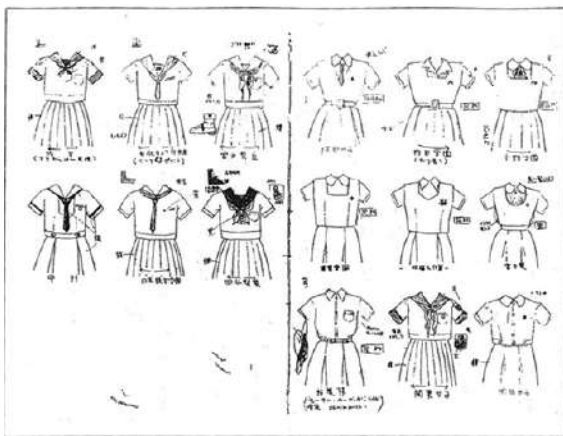

2ワサの純白セーラーは英国人の発案  
24 東京女学館高等学校

入試倍率は都内の女子高で1位  
28 富士見丘高等学校



整理段階のメモの一部  
『東京女子高制服図鑑』85年版より

Object 3: Street Observation Society 1985 Study of Tokyo Schoolgirl fashion



An inside image of issue No.1 of Fruits Magazine (Aoki 1996).  
『Fruits』の創刊号

Object 4: Fruits Magazine, Harajuku Fashion Shoichi Aoki, 1996

The relationship between politics and curation often becomes present in the methods of collecting the city. Jordan Sand discusses the significance of an object for the 20th century history museum curation as lying in its usage rather than its mode of production, pointing to the shift from human-to machine made objects.<sup>28</sup> The evolution of society narrated through the development of such exhibits (automobile, computer, airplane, etc.) leads to their positioning as singular symbols of progress. This notion of curation unconsciously establishes consumerism as a representation of cultural maturation. Refusing this trajectory, Street Observation Society took a radically anti-monumental approach, claiming that “[...] we have become sick of intentional things.”<sup>29</sup> [Fig. 10]

The “things” the Society sought after exist in another realm that “deviates from the boundaries of intention” —traces and (by)products of incidents or accidents that, instead of being produced, await to be discovered and documented as inconsumable totems. “Marginal” curations of the everyday juxtaposed with “monumental” curations reveal the latter as a mode of representation rather than a way of life. The group aimed to criticize the development of institutional planning that showed no interest in the preservation of local and historical characteristics, and thus interpreted fieldwork and observation as a way to instil grassroot considerations in planning.

The self-portraits of anonymous, ordinary people in the margins of the dominating urban discourse operate on the terms of self-preservation. Street Observation Society established its “collection of the unintentional” by documenting “anti-products” and introduced an approach towards the recording of daily life that is interested more in matters of perceptibility rather than in objects and their commercial extensions. Assuming the active role of “detective” research counteracted the passive user-consumer subjectivity. The group called for an activate community of detectives always on the ready to document unexpected urban events, embodying an ethos not unlike Jane Jacobs’ “eyes on the street.” In this context, curation comprises a multi-authored text produced by community collecting and intending to establish grassroots, bottom-up and decentralized agency in the urban realm [Figs. 11-12].

---

28 Ibid. 358

29 Teronobu Fujimori; and Thomas Daniell, “Under the Banner of Street Observation,” n.d.

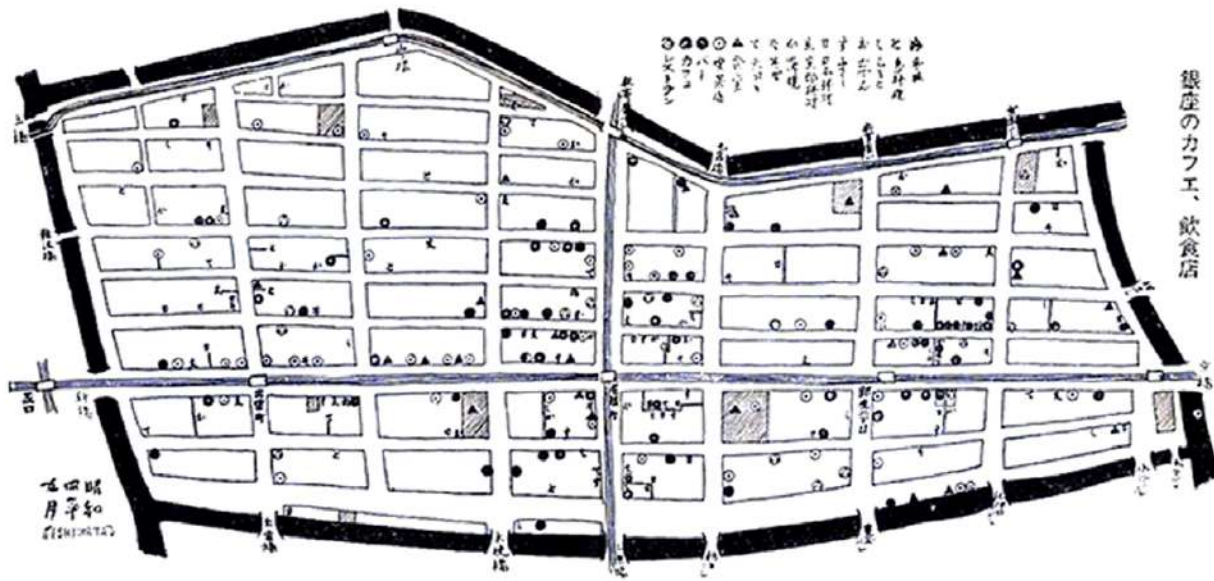

Object 1: Ginza Survey of Cafes, Kon Wajiro, New Guide to Tokyo, 1929

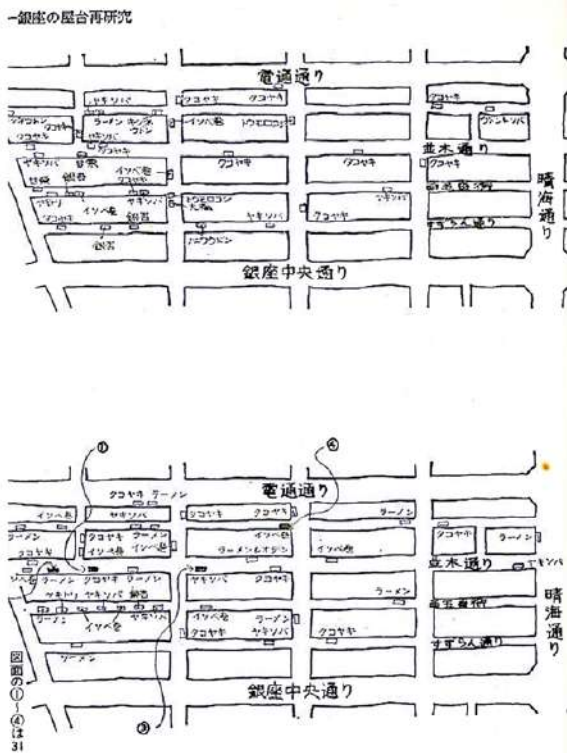

Object 2: Ginza Survey of Street Market Stalls Teruhiko Mochizuki, Machinology, 1977

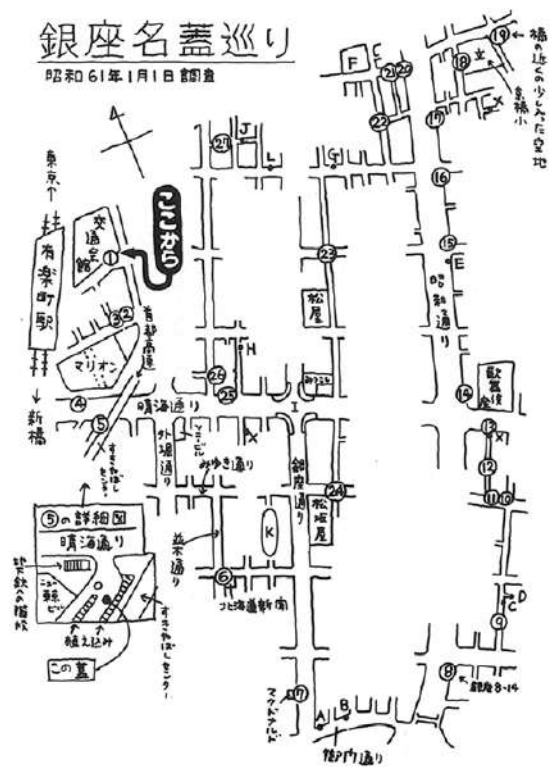

Object 3: Ginza Survey of Manholes Street Observation Society, 1986

FIG.11 Trajectory of Ginza's floor plans. Different individuals survey the city in search for different objects. Cafes, Street Market Stalls and Manholes, 1929, 1977, 1986.



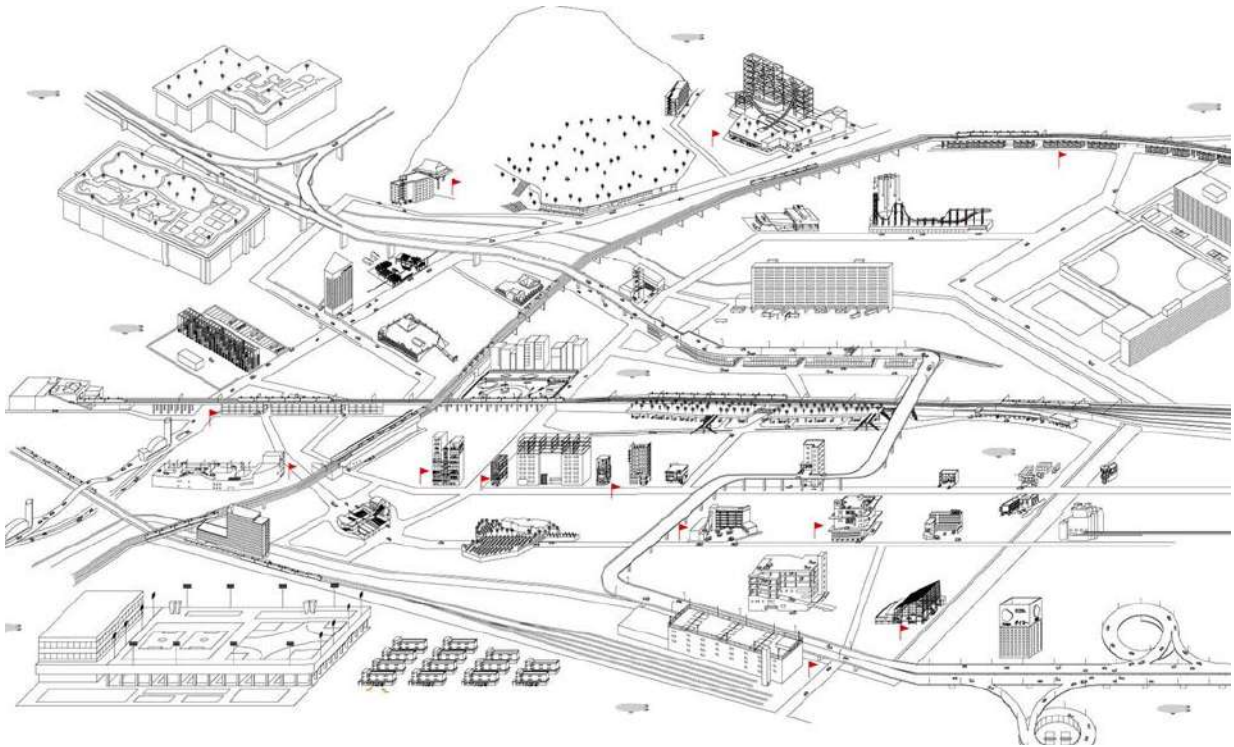

FIG.12 Made in Tokyo, Atelier Bow-Wow and Junzo Kuroda, 2001

## Curating as caring: Made in Tokyo Guidebook (2001)

During Tokyo's "Bubble Economy" years (1986-1991), speculative real-estate development and an unprecedented rise in land prices produced an unintelligible landscape of conflicting building programs that reflected loose urban regulations and the absence of effective planning policies. The architecture practice Atelier Bow-Wow attempted to make sense of the resulting incoherent urban landscape through the exhibition and subsequent guidebook of "Made in Tokyo".

In Tokyo, buildings are exhibits, and by walking around with a guidebook in one hand, the city is turned into a museum. What does the guidebook do? It teaches how to appreciate architectural works, and how to view and read architecture.<sup>30</sup>

The project was first presented as an installation at "Camera Obscura or the Architectural Museum of Revolutions,"<sup>31</sup> an exhibition curated by the architect Arata Isozaki and featuring the work of four young practitioners on the theme of urban transformation as a result of social revolution. An updated and expanded version of the project was published in 2001 as a book.

30 Jun Tanaka in Hiroshima City Modern Museum, *Rojō to Kansatsu o Meguru Hyōgenshi: Kōgengaku No Genzai* [Expressive History of Street and Observation: Kōgengaku's Present], 13.

31 (Met Hall, Metropolitan Plaza of Ikebukuro 1996) "No Title," n.d., [http://www.dnp.co.jp/museum/nmp/nmp\\_b/watch/Dec24\\_e.html](http://www.dnp.co.jp/museum/nmp/nmp_b/watch/Dec24_e.html).

Made in Tokyo proposed a new architectural type, that of “Da-me Architecture” (“No-good architecture”) as a unit through which to interpret urban space. Comprising a survey of seventy idiosyncratic, at times bizarre, cases of vernacular and commercial architecture across the city, the project was an attempt to find certain rationales behind the blending of disparate forms and functions through contextualizing them in relation to the diversity of spatial conditions that comprise the unique environment of Tokyo. According to Atelier Bow-Wow, if “urban chaos” is read through a different lens—as an interaction and unison of divergent functions such as distribution, transportation, communication, production, or residence—then the end-product acquires new value as an “urban problem-solver”. In order to arrive at this “discovery,” a sincerely questioning attitude toward what makes a city “good” is necessary—both the establishment of new criteria of judgment that transcend common sense, and the confrontation of existing values. If seen from this perspective, the peculiarities of Tokyo’s urban space become reasons to celebrate “Tokyones”. These idiosyncratic expressions, then, become reflections of seemingly disjointed and chaotic urban activities, characterized by an underlying rationality that informs and connects each seemingly autonomous urban unit.

For example, in the case of Cine-Bridge<sup>32</sup> [Fig. 13], pedestrian infrastructure and underground shops merge into a whole to accommodate the different stakeholders’ needs for land use. If evaluated through the lens of aesthetics, the result can easily be deemed a failure. However, if the framework changes to the effectiveness of addressing multiple urban needs within a single entity, then this same building can be judged as successful. Thus, the urban curatorial framework of “Da-me architecture” revalues these heterogenous spatial assemblages from ugly to valuable entities. The seeming lack of meaningful connections within the city’s fabric exposes and at the same time fills the gaps in the way the city is perceived and experienced. In this case, curating becomes a form of “caring and saving” these urban entities from unjustified metaphorical or literal demolitions. As the authors of the more recent publication *Architectural Ethnography* articulate, Made in Tokyo “describes an architecture that, far from attempting to control the surrounding environment, is itself defined and shaped by the accidents of the site and the participation of the people who inhabit it.”<sup>33</sup>

---

32 Tsukamoto Yoshiharu; Momoyo Kuroda, Junzo; Kajijima, *Made in Tokyo: Guide Book* (Kajijima Institute Publishing Co., 2001), 48.

33 Momoyo Kajijima, Laurent Stalder, and Yu Iseki, *Architectural Ethnography: [Japanese Pavilion Venice Biennale 2018]* (Tokyo: Toto, 2018), 8.

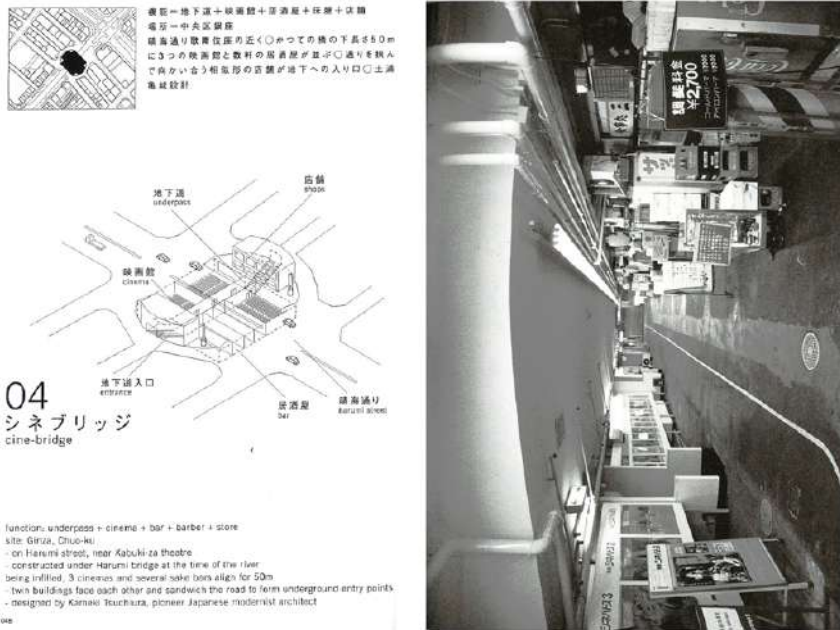

FIG.13 Cine-bridge, Made in Tokyo, 2001

## Conclusion

Tokyo’s fieldwork projects and guidebooks emerged in times of urban transformation throughout the 20th century, as a result of the work self-organized groups and individuals who undertook documenting and interpreting of a rapidly changing urbanity. Along the way, these projects contributed to the discourse on what parts of the city are worth collecting. The artistic intentions, the selection of the represented themes, and their justifying narratives give a decidedly curatorial dimension to these fieldwork and guidebook publications. In the same manner that a curator carefully selects and arranges the objects that will be displayed in an exhibition, works by Kon Wajiro, the Street Observation Society and Atelier Bow-Wow identify and discuss seemingly unimportant or marginal elements. These objects and buildings are selected not for being the main protagonists of the transformation of the city, but due to their imminent disappearance. Essentially then, the city’s change can be understood and measured through the extinction of things that used to be taken for granted, amidst the emergence of new, unexpected aspects.

Surveying becomes an important strategy for representing the entities disappearing from the urban fabric, allowing for a contextual reading<sup>34</sup>. Positioning objects in their urban setting and providing the contextual relations of their use comprises a Lefebvrian cartography of representational or lived space. Firmly grounded in the material realm, it is a way to contextualize objects vis-à-vis the people who use them. This approach extends the scope of urban curatorial practices and establishes a new object of urban curation: citizens’ interpretations of their living environment. Starting with Modernology in the 1920s, this urban curatorial

34 In Antoš, “Collecting’ the Present in Ethnographic Museums,” 120.

approach also created a new mode of urban subjectivity: the figure with large eyeglasses, pen and sketch paper in hand, taking to the streets ready to describe soon-to-be-extinct objects. The subject-as-consumer, formed in the context of modernizing Tokyo, gave way to a new perspective, that of reading space through the material realm and the assembly of objects. The study of the subject's relation to these objects became a focal point for the reading of urban phenomena, establishing a new relationship within the city.

The "collections of the present" discussed in this study have been cross-examined to map historical trajectories of urban objects, a process in which the observing subjects themselves becomes the object of curation. In the four trajectories drawn out in Figures 7, 8, 10 and 11, urban fieldwork that took place in different points in time have been juxtaposed into an assemblage of interpretation and a history of the observer. The selection of objects, the attempt to understand their qualities and their subsequent categorization into different groups resulted in trajectories of different "collectors". These are: (1) façade studies (2) street stalls (3) fashion surveys and (4) ginza's floor plans. The working together with recurring themes, narratives and ways of organizing the information collected from the city informs the notion of the lineage discussed in the paper. Even though seemingly unconnected, the works adopt a vocabulary that forms part of a common language, where the way to live and collect the city has a precedent in the ethnographic work of Kon Wajiro following the 1923 Great Kanto Disaster. Ever since, vigilant eyes have attempted to document in the same manner things that are considered vulnerable or survived Tokyo's metamorphoses.

If the face of the contemporary city changes constantly as a result of major social, political and economic transformations, the citizens who conduct their lives within this context are left to step in as meaning-makers for the city, compensating for the gaps of the planning process. A clarity of reading, unable to be accomplished by architectural design and urban planning alone, can be achieved by establishing new vocabularies to engage the city. Each of the publications examined in this paper takes a unique stance towards the way urban transformation occurs, producing its own curatorial narrative in the process. Once a vocabulary for reading the city is in place, it allows to mentally reorder it from bits and pieces to a meaningful whole. This act of reading goes against the grain of the status quo of spatial production that is incoherent, dispersed, follows real-estate imperatives, leaving the task of meaning-making unaddressed.

Nearly a decade after the Great East Japan Earthquake of 2011 and immediately before the postponed Olympics of 2021, contemporary Tokyo is yet again experiencing urban transformations that are reshaping its identity, propelled by neoliberal processes. Curating Tokyo in this context calls for many voices, media and fields of inquiry, so that the reading of the

city can comprise a multiplicity of layers. A new generation of fieldwork studies and surveys are underway,<sup>35</sup> attempting to make sense of the new developments and archiving the things that are expected to disappear sooner or later. The maze of Tokyo's tightly packed downtown streets and its complex railway network, all crisscrossed by old and new media, remains the fertile site of urban curatorial practice: reading and shaping the city through fieldwork and guidebooks.

**Anastasia Gkoliomyti** (b.1992) received her M.Arch from National Technical University of Athens in 2018. After receiving a scholarship from Japan's Ministry of Education, Culture, Sports, Science and Technology to pursue studies in Japan, she now does research as part of Tsukamoto Laboratory at Tokyo Institute of Technology. Her interests include cross-cultural studies of space, geography and anthropology of spatial practices, themes which were explored in her thesis: "Geography of Thought: The Japanese Tearoom" (NTUA, 2017).

**Yoshiharu Tsukamoto** (b.1965) is Professor of Architecture at Department of Architecture and Building Engineering, Tokyo Institute of Technology. Together with Momoyo Kaijima they established the architectural firm Atelier Bow-Wow in 1992. Yoshiharu Tsukamoto is head of Tsukamoto Laboratory, with interests of integrating existing design theories with the concept of behaviorology. He has also been visiting professor at Harvard University, University of California, Los Angeles, Cornell University, Rice University, Columbia University, Delft University of Technology, and the Royal Danish Academy of Fine Arts.

---

35 For example, Tokyo Behaviorology by Yoshiharu Tsukamoto laboratory at Tokyo Institute of Technology, Shibuya Research by Kuroishi Izumi Laboratory at Aoyama Gakuin University to name a few

## References

- Akasegawa, Genpei, Terunobu Fujimori, and Shinbō Minami. *Rojō Kansatsugaku Nyūmon [Street Observation Studies Primer]*. Tokyo: Chikuma Shōbō, 1986.
- Angelidou, Ioanna. "Touring the Urban Quotidian," 1-10. In *Barcelona: International Forum on Urbanism*. Barcelona: Escola Tècnica Superior d'Arquitectura de Barcelona, 2012. <https://upcommons.upc.edu/handle/2099/12148>.
- Bhaskar, Michael. *Curation: The Power of Selection in a World of Excess*. Boston: Little, Brown Book Group Limited, 2016.
- Antoš, Zvezdana. "'Collecting' the Present in Ethnographic Museums." *Ethnological Research*, no. 18/19 (2013): 115-128.
- Berry, Mary Elizabeth. *Japan in Print: Information and Nation in the Early Modern Period*. Berkeley, Calif: University of California Press, 2006.
- Bourdieu, Pierre, Gisele Sapiro, and Brian McHale. "First Lecture. Social Space and Symbolic Space: Introduction to a Japanese Reading of Distinction." *Poetics Today* 12, no. 4 (1991): 627. <https://doi.org/10.2307/1772705>
- Chapman, Edmund H., and Kevin Lynch. "The Image of the City." *The Journal of Aesthetics and Art Criticism* 21, no. 1 (1962): 91. <https://doi.org/10.2307/427643>.
- Fruneaux, Christiaan, and Edwin Gardner. *Tokyo Totem: A Guide to Tokyo*. Tokyo: Flick Studio, 2012.
- Fujimori, Teronobu. "Under the Banner of Street Observation." In *Street Observation Studies Primer*, edited by Genpei Akasegawa, Teronobu Fujimori, and Shinbo Minami, 6-22. Tokyo: Chikuma Shōbō, 1986. <http://forty-five.com/papers/154>.
- Hiroshima City Modern Museum. *Rojō to Kansatsu o Meguru Hyōgenshi: Kōgengaku No Genzai [Expressive History of Street and Observation: Kōgengaku's Present]*. Tokyo: Filmart, 2013.
- Hiroshima MOCA. "Eyes on the Street: Modernology and Beyond," 2013. <http://www.hiroshima-moca.jp/>.
- Ishida, Yorifusa "Ougai Mori and Tokyo's Building Ordinance." In *Tokyo: Urban Growth and Planning 1868-1988*, edited by Hiromichi Ishizuka and Yorifusa Ishida, 83-86. Tokyo: Iwanami Shoten, 1988.
- Jane, Jacobs. *The Death and Life of Great American Cities*. New York: Random House, 1961.
- Jokilehto, Jukka. *A History of Architectural Conservation: The Contribution of German, French, English and Italian Thought towards an International Approach to the Conservation of Cultural Property*. York: The University of York, 1986. <https://www.iccom.org/publication/history-architectural-conservation>.
- Kajijima, Momoyo, Laurent Stalder, and Yu Iseki. *Architectural Ethnography [Japanese Pavilion Venice Biennale 2018]* Tokyo: Toto, 2018.
- Kobayashi, Teppei, Yasuaki Onoda, Katsuya Hirano, and Michio Ubaura. "Practical Efforts for Post-Disaster Reconstruction in the City of Ishinomaki, Miyagi." *Journal of Disaster Research* 11, no. 3 (2016): 476-485. <https://doi.org/10.20965/jdr.2016.p0476>.
- Kon, Wajirō. *Shinpan Dai Tokyo Annai [New Guide to Tokyo]*. Tokyo: Chuo Koronsha, 1929.
- Kon, Wajirō, and Terunobu Fujimori. *Kōgengaku Nyūmon [Introductory study]*. Tokyo: Chikuma Shobō, 1987.

- Kuroishi, Izumi. "Urban Survey and Planning in Twentieth-Century Japan: Wajiro Kon's 'Modernology' and Its Descendants." *Journal of Urban History* 42, no. 3 (2016): 557-581.  
<https://doi.org/10.1177/0096144216635151>
- . "Visual Examinations of Interior Space in Movements to Modernize Housing in Japan, c. 1920-40." *Interiors: Design, Architecture, Culture* 2, no. 1 (2011): 95-123.  
<https://doi.org/10.2752/204191211X12980384100193>.
- Mochizuki, Teruhiko. *Machinorojī: Machi no bunka-gaku [Townology. A Cultural Study of the City]*. Tokyo: Soseiki, 1977.
- Mohanty, Satya P. "Us and Them on the Philosophical Bases of Political Criticism." *New Formations* 8, no. 8 (1989): 55-80.
- Ogawa, Takeshi. *Randebū No Annai: Ryusenkei Abekku [Rendezvous Guide: Fashionable Dates]*. Tokyo: Marunouchi shuppansha, 1935.
- Ooms, Herman, and Marcia Yonemoto. "Mapping Early Modern Japan: Space, Place, and Culture in the Tokugawa Period (1603-1868)." *The Sixteenth Century Journal* 35, no. 3 (2004): 939.  
<https://doi.org/10.2307/20477120>.
- Oshima, Ken Tadashi. "Rediscovering Japanese Urban Space in a World Context." *Journal of Urban History* 42, no. 3 (2016): 623-633. <https://doi.org/10.1177/0096144216635165>.
- Rykwert, Joseph. *The Idea of a Town: The Anthropology of Urban Form in Rome, Italy and the Ancient World*. MIT Press, 1988.
- Sand, Jordan. "Monumentalizing the Everyday: The Edo-Tokyo Museum." *Critical Asian Studies* 33, no. 3 (2001): 351-378. <https://doi.org/10.1080/14672710121867>).
- . "Between Imperial Capital and World City: The Tourists' Tokyo a Century Ago." *Kamizono. Journal of the Meiji Intercultural Research Institute*, no. 16 (November 2016): 162–169.
- . "Imperial Tokyo as a Contact Zone: The Metropolitan Tours of Taiwanese Aborigines, 1897-1941." *The Asia-Pacific Journal: Japan Focus* 12, no. 4 (March 2014). <https://apjif.org/2014/12/10/Jordan-Sand/4089/article.html>).
- Silverberg, Miriam. "Constructing a New Cultural History of Prewar Japan." *Boundary 2* 18, no. 3 (1991): 61. <https://doi.org/10.2307/303203>
- . "Constructing The Japanese Ethnography Of Modernity." *The Journal of Asian Studies* 51, no. 1 (1992): 30-54. <https://doi.org/10.2307/2058346>
- Smith, Henry D. "Tokyo as an Idea: An Exploration of Japanese Urban Thought until 1945." *Journal of Japanese Studies* 4, no. 1 (1978): 45-80. <https://doi.org/10.2307/132072>
- Sorensen, André. *The Making of Urban Japan: Cities and Planning from Edo to the 21st Century*. London: Routledge, 2002.
- Tsukamoto, Yoshiharu, Momoyo Kaijima, and Junzo Kuroda. *Made in Tokyo*. Tokyo, 2000.  
<https://doi.org/10.11235/buyougaku1978.2001.99>.
- Urry, John. *The Tourist Gaze: Leisure and Travel in Contemporary Societies*. New York: Sage Publications, 1990.

University College London. "Curating the City | Centre for Critical Heritage Studies." Accessed December 7, 2019. <https://www.ucl.ac.uk/critical-heritage-studies/curating-city>.

Waley, Paul. "Placing Tokyo in Time and Space." *Journal of Urban History* 39, no. 2 (2013): 331-335. <https://doi.org/10.1177/0096144212465403>

"Japan in Print: Information and Nation in the Early Modern Period." *Choice Reviews Online* 44, no. 2 (October 1, 2006). <https://doi.org/10.5860/CHOICE.44-1090>



## MAIN SECTION

# Recognizing the Scenic Value of the City: Ephemeral Architecture as a Medium to Evoke Urban Memories

Alessandro Mosetti – IUAV (Italy) – Contact: amosetti@iuav.it

## ABSTRACT

Today, “urban regeneration” is often argued as being the only way to revitalize those urban sections of cities that have been forgotten or, one way or another, trivialized by consumer culture and tourism, both of which assault cities and tend to turn them into open-air fun-fairs. Instead, we should be suggesting a process of “regenerating the collective memory” of the city through public exhibitions, which was the intention behind the Venice Biennale and other cultural events instituted in cities during the '70s and '80s. How can such ephemeral architecture in the form of a public exhibition help in this endeavor? In the late '70s, public exhibitions in Venice paved the way to a transparent methodology aimed at unifying both the Venetian and international vocations of the city's Biennale, railing against the prevalent tendency towards a standardization of exhibitions. This aspect, today lacking, is one of the reasons why Venice is now perceived as an open-air museum rather than an active theatre for collective memory. Recovery, study, and a re-drafting of this geography of nonexistent places could offer a scenario of what might be recouped in the future as a methodology for upcoming exhibitions, in order to tackle the danger of Venice becoming a passive museum.

## KEYWORDS

*Strada Novissima; Venice Biennale; Ephemeral Architecture; Memory; Scenic Space*

## PEER REVIEWED

<https://doi.org/10.6092/issn.2612-0496/10129>

ISSN 2612-0496

Copyright © 2020 Alessandro Mosetti



FIG. 1 The lighthouse theatre with two scenes (Aldo Rossi, 1988), ©Eredi Aldo Rossi, courtesy Fondazione Aldo Rossi

## Introduction

This study assumes that all forms of ephemeral architecture for urban design are a meaningful mindset to intervene in the public spaces of the contemporary city. The case studies in this work have come from Venice which is an emblematic place where the use of ephemeral instances has long shaped the way of thinking about the urban role that an exhibition has when arranged/set up in a public space.

The theater is very similar to ephemeral architecture since both involve an event—its beginning, development, and conclusion. Without an event, there is no theater and no architecture.<sup>1</sup>

An ephemeral architecture project is nourished by the notion of memory whenever it gives a scenic value to the city in which it is acting.<sup>2</sup> This corresponds to a strengthening of the theoretical link between scenography, architecture, and city, where the latter is none other than a theater and an object of representation. Considering this theoretical link as the foundation for any intervention in a city, urban ephemeral architecture can recover the nature of the city which it has always realized: this implies a reinforcement of the evocative power of buried memories while bringing out the meaning of the Latin term *ephemerus*. Far from being

1 Aldo Rossi, *A Scientific Autobiography*, transl. Lawrence Venuti (Cambridge, Mass.: MIT Press, 1981), 48.

2 Frances A Yates, *The Art of Memory* (Chicago: University of Chicago Press, 1966).

derogatory, its real significance can be perceived by analyzing its archetypical meaning. The term *ephemerus*<sup>3</sup> represents the feverish power of a moment perceived as the pinnacle of desire—the shortest temporality at the highest temperature. For the purposes of this research, the Latin definition has been adopted since it adds the principle of reiterating the fever apex over a prolonged period to the notion of transience.

Theater or scenography, scenography or architecture, what other means represent history in the same way?<sup>4</sup>

The two quotes of Aldo Rossi connect the notion of the city, seen as a theater, to that of architecture seen as an actress.<sup>5</sup> These events draw nourishment from the history of the city by tallying urban memory with collective memory.<sup>6</sup> By defining the architectural project as an actor, the intention is to communicate a message or a mnemonic narration that is proper to the city theater, returning it to collectivity. In the preface to *The Architecture of the City*, Eisenman refers to the city as a giant or collective house of memory, which has a psychological reality arising from its being a place of fantasy and illusion, an analogue of both life and death as transitional states.<sup>7</sup> [Fig. 1]

Hence, the objective is to recover the meaning of the city as a theater of memory. Works of architecture making up the urban space are fundamental elements within a scheme which recalls the ancient art of mnemotechnics.<sup>8</sup> Thus, the city is subject to the deposition of collective memory and can serve as an atlas of our history.

---

3 Gian Biagio Conte, Emilio Pianezzola, and Giuliano Ranucci, "Ephemerus," in *Il Latino. Vocabolario della lingua latina* (Milan: Le Monnier, 2010).

4 Alberto Ferlenga, *Aldo Rossi: tutte le opere* (Milan: Electa, 2000).

5 Architecture is conceivable, on an urban scale, as a theater. On the link between scenography-architecture and the city, see Silvia Cattiodoro, *Architettura scenica e teatro urbano*, (Milan: FrancoAngeli, 2007).

6 Maurice Halbwachs and Lewis A. Coser, *On Collective Memory*, *The Heritage of Sociology* (Chicago: University of Chicago Press, 1992); Jacques Lacan, *The Four Fundamental Concepts of Psychoanalysis* (London: Routledge, 2018).

7 Peter Eisenman, "The House of Memory," in Aldo Rossi, *The Architecture of the City*, transl. Diane Ghirardo and Joan Ockman (Cambridge, Mass.: MIT Press, 1982), 10.

8 Fabio Ferrucci, *L'arte della memoria di Giordano Bruno. Il trattato "De umbris idearum" rivisto dal noto esperto di scienza della memoria* (Milan: Anima, 2005).



FIG. 2 Redrawing of the *Theatrum Orbi* as presented in Robert Fludd, "Ars memoriae" in *Utriusque Cosmi. Maioris scilicet et minoris metaphysica, physica atque technica Historia* (Oppenheim: Hieronymi Galleri, 1617), 55

## Setting up, displaying, and dismantling

Urban ephemeral architecture acts in the field of brevity, but powerfully assumes the communicative urgency sought by the curator as the constructive character of the stage set. Scenic architecture needs to be built as the representation of a story which, in turn, becomes a theatrical spectacle within the larger theater, namely, the city [Fig. 2].

If we hold onto the concept of mnemotechnics in the background when studying Rossi's well-known projects for the *Teatro del Mondo* (Venice, 1979) and the *Teatro Faro* (Toronto, 1988) things become clearer. They allow us to explore two key issues: on the one hand, the object of communication of which the set-up architecture is the spokesperson (i.e., a representation of urban memory) and, on the other, the construction of the scene within which the performance takes place (i.e. the scenography). The first project could be read<sup>9</sup> in the light of Giulio Camillo's *Teatro della Memoria* described in his essay entitled *L'idea del teatro*.<sup>10</sup> Assuming that the typological definition of the theater is a device supporting *ars memoriae* and in an indissoluble link with the architecture, Rossi's *Teatro del Mondo*

9 Rafael Moneo, "L'apparenza come realtà. Considerazioni sull'opera di Aldo Rossi," in *Intorno ad Aldo Rossi e alla sua architettura*, edited by Chiara Occhipinti (Milan: Politecnico di Milano, 2013), pp. 35–41.

10 Giulio Camillo, *L'idea del teatro*, edited by Lina Bolzoni, *L'Italia 02* (Palermo: Sellerio Editore, 1991).



FIG. 3 Prospettiva della prima macchina nelle sue parti d'architettura rilevate rappresentante un ameno giardino, entro di cui s'inalza edificio, che nella sua eminenza forma un'ampia nicchia quadrifronte al simulacro di Hilaritas Publica, (Vasconi F., 1728), ©Biblioteca Casanatense, Roma.

is thus a work of architecture capable of narrating events which belong to the designer, the city, and the lagoon: a collection of memories acquired from the context and returned to it. On the other hand, the *Toronto Teatro Faro* was depicted through drawings of two scenes—tragedy and comedy—which face each other simultaneously. The coexistence of tragedy and comedy in life, as well as in the city as theater, harks back to Serlio's well-known urban scenes which did not slot them into a system of comedy, satire and tragedy.<sup>11</sup> The term 'comedy' can also suggest a playful personality: close to the one Filippo Vasconi seemed to refer to when dedicating his ephemeral architecture projects to the *Roman Hilaritas publica* [Fig. 3].

The city as a theatre stages all potential performances simultaneously, amending the vision of a fragmented torn city as represented in Rossi's etching *Architetture Assassinate* dated 1975.<sup>12</sup> Architecture takes part in the game without a timeframe or memory of its place; it collects buried memories and returns them to the city, at which point collective memory reinterprets them. In the depths of the timeless design of the *Analogous City* montage,<sup>13</sup> Rossi exploited a system of memories of what had been built and what was as yet unrealized, aiming to define a city which one could believe to have always inhabited. Likewise, the montage here is a paratext alongside the written body of the paper as the most effective

11 Sebastiano Serlio, *Tutte l'opere d'architettura di Sebastiano Serlio, Bolognese: dove si trattano in disegno, quelle cose, che sono piu necessarie all'architetto* (Venice: Francesco de Franceschi Senese, 1584).

12 See Rossi's etching entitled *Questo ora è perduto* (1975).

13 Aldo Rossi, "La città analoga," *Lotus*, no. 13 (1976): pp. 4–7; Manfredo Tafuri, "Ceci n'est pas une ville," *Lotus*, no. 13 (1976): pp. 8–10.

way to highlight the psyche's construction from which the portions of memories have emerged and how these returned to the reader.

This study illustrates several images made up of different techniques: montages by juxtaposition, overlapping of multi-temporal layers, photographs of models, or drawings on an architectural scale; all images pursuing the assemblage technique, unveiling their archetypal origin through a stratigraphic/iconographic excavation. If the representation staged by the architecture of the city speaks of memory and finds its correspondence in a theater in which every citizen is the main character, it seems obligatory to broaden the notion of temporality in order to fully understand the theoretical and compositional structure of urban ephemeral architecture. Temporality is a paramount factor in an architectural project which already postulates its finale in the planning phase. Splitting the temporality of the project into the three acts identified by Rossi as "beginning," "development" and "conclusion," could prove more effective.<sup>14</sup> However, in the case of urban ephemeral architecture, this tripartition can also be symmetrically translated into "setting-up," "displaying" and "dismantling." It is interesting to note how the practice of rearranging an exhibition elsewhere introduces an unexpected fourth "act" with uncertain outcomes: although the event ends, the exhibition continues as a potential *monumentum*. The practice of rearranging, relocating elsewhere and at other times, can keep the ephemeral alive beyond the end of the exhibition.

## Rearticulating Leoncilli's "Venezia e lo spazio scenico"

Up to this point, this investigation has shown the essential theoretical themes to frame a design methodology with ephemeral architecture at its center. In order to show the actual functioning of such a methodology, the study delved into two emblematic case studies, both generated in Venice: the set-up designed by Gian Carlo Leoncilli Massi for the *Venezia e lo spazio scenico* exhibition (1979) and the rearranged set-up of *Strada Novissima* (under the name *The Presence of the Past*) at the Fort Mason Center of San Francisco in 1982. For the first case study, the goal was to probe the fallout in mnemonic terms of a multi-scale scenic project built in line with the three "acts." For the second one, the objective was to propose an analysis of the critical issues in staging the "fourth act." This case study will be read in relation to the original act of the first version curated by Francesco Cellini and Claudio D'Amato in 1980 for the *First International Architecture Exhibition* in Venice.

Gian Carlo Leoncilli Massi arrived in Venice in 1975 in a period that was critical both for Italian ephemeral architecture and the significant structural changes in progress within the Venice Biennale. As a matter of fact,

---

14 Rossi, *A Scientific Autobiography*, p. 48.

1975 marked the debut of the Architecture sector within the Biennale.<sup>15</sup> On a large scale, Leoncilli is best known for his scenography projects for the *Festival dei Due Mondi* in Spoleto (1997, 1980, 1983). He graduated from the Sapienza University of Rome under Ludovico Quaroni; he trained as a teacher at the IUAV in Venice where he taught until 1987 when his research activity<sup>16</sup> shifted to the Faculty of Architecture of the University of Florence. The possibility of managing the set-up of the 1979 Theater-Architecture Biennale arose in Venice which had already seen active use of its public spaces for exhibition purposes.<sup>17</sup> Suffice to observe what occurred in Rome in those same years to clearly understand the structure of the *Venezia e lo spazio scenico* exhibition. The first inkling came in 1977, the year of the *Estate Romana* by Renato Nicolini,<sup>18</sup> who had proposed an exhibition which narrated the historical city and paved the way for a process of maturation of what would begin in Venice two years hence: the recovery of lost urban memory, a thought on the active use of the city, far from being a museum only open to tourism. The ephemeral medium adapts to these purposes and unfolds its meaning on two interconnected levels: a physical one and a mental one linked to time and the sedimentation of collective memory through the architectural project. Once again, the theater is seen as an architectural device to transform an ordinary public space into an extraordinary one.<sup>19</sup>

The second impulse was the well-known *Roma Interrotta* exhibition,<sup>20</sup> mounted at Trajan's Market in 1978 which inspired architectural drawings for a Rome much closer to a possible *Analogous City*,<sup>21</sup> able to safeguard the twelve mnemonic design archives of different origins. In the light of these projects, it is easier to understand the "renewed use of ephemeral architectural"<sup>22</sup> which Paolo Portoghesi and Maurizio Scaparro discussed

---

15 At that time, Vittorio Gregotti was director of the Visual Arts sector. See the interview with Vittorio Gregotti in: Aaron Levy and William Menking, *Architecture on Display: On the History of the Venice Biennale of Architecture* (London: AA Publications, 2010).

16 Gian Carlo Leoncilli Massi, *La composizione commentari* (Venice: Marsilio, 1986); Gian Carlo Leoncilli Massi, *L'etrusco torna a scrivere* (Florence: Alinea, 1997); Gian Carlo Leoncilli Massi, *La leggenda del comporre* (Florence: Alinea, 2002).

17 In 1972, with the exhibition *Sculptures in the City*, the 36<sup>th</sup> Art Biennale took place in public spaces (*campi, calli* and courtyards) in order to exhibit large sculptures of composite material. During this period, the idea of the exhibition was to create a design laboratory or competition focusing on the city and its problems. On the Architecture Biennale seen as a design laboratory, see Aldo Rossi, *Venice Project. Third International Exhibition of Architecture* (Venice: La Biennale di Venezia, 1985), p. 13; Francesco Dal Co, *Quinta mostra Internazionale di Architettura* (Milan/Venice: Electa, 1991).

18 Renato Nicolini, *Estate romana* (Siena: Sisifo, 1991); Renato Nicolini, *Estate romana: 1976-85: un effimero lungo nove anni* (Reggio Calabria: Città del Sole, 2011).

19 See the project for the "scientific theater" in *Via Sabotino* (1979) by Franco Purini and Laura Thermes.

20 Giulio Carlo Argan and Christian Norberg-Schulz, *Roma interrotta* (Rome: Officina Edizioni, 1978).

21 It is interesting to relate the work of *Roma Interrotta* to the exhibition *10 Immagini per Venezia*: an event curated by Francesco Dal Co and held in Venice in 1981. See Francesco Dal Co, *10 immagini per Venezia* (Roma: Officina Edizioni, 1980).

22 Paolo Portoghesi and Maurizio Scaparro, "Venezia teatro del Mondo," in *Venezia e lo spazio scenico*, edited by Manlio Brusatin (Venice: The Venice Biennale, 1980), p. 7.

in the introduction to the official catalog of the *Venezia e lo spazio scenico* exhibition. The title of the exhibition summarizes the connection between the city and the theater.<sup>23</sup> The exhibition set-up addressed the possibility of building free ritual routes<sup>24</sup> through the city's intricate labyrinth:

[...] today there is a risk in a world that has become only image, that allegory is no longer intended "as a means, but as an end." My interest consists in considering "Architecture as thought" or "building a thought in architecture" [...]<sup>25</sup>

In this way, Leoncilli's project<sup>26</sup> recognized the intricate link between the play of memory<sup>27</sup> and the scenic representation of the city (or self-representation) by means of the scenic structuring of certain public places in Venice.<sup>28</sup> When set up, the project went beyond the scale of the architectural design and, as in the *Roma Interrotta* drawings, looked at the scale of the city as it turned itself into a multi-scale scenic project.<sup>29</sup> Leoncilli's scenic program involved the selection of twelve sites for which he suggested specific settings. An iconographic representation of the city was necessary to highlight the routes and sites, and to this end Leoncilli produced three plans to supplement the official exhibition catalog: *Venezia Storica* (a historical map of Venice dated 1729), *Venezia Attuale* (a map of Venice and its public transport network in 1979) and a *Game of the Goose* board [Fig. 4].

Just like Rome in the twelve panels by Giovanni Battista Nolli presented for *Roma Interrotta*, Venice is harnessed within a network of two hundred square meters where twelve sectors have been highlighted. The waterways, the boat routes and pedestrian thoroughfares are shown on the grid. Aldo Rossi's *Teatro del Mondo* is a part of this major network of places, standing as a visual pivot of Saint Mark's Basin. The *Game of the Goose* board set the rules for taking part as both designers and visitors; the chosen sites are highlighted inside the boxes: each site evokes its historic scenic role. Within the urban grid, Leoncilli drew – at the scale

23 Ludovico Zorzi, "Intorno Allo spazio scenico veneziano," in *Venezia e lo spazio scenico*, pp. 81–109; Ludovico Zorzi, *Il teatro e la città: saggi sulla scena italiana* (Turin: Einaudi, 1977).

24 On this point, see the 1975 *Living Theater performance called Seven Public Acts—Seven Curses on Political Sodomasochism*. This is a ritual procession that traveled through the city along the streets and across the squares to end up at the deconsecrated Church of San Lorenzo.

25 Gian Carlo Leoncilli Massi, Giovanni Fraziano and Aldo Rossi, *I labirinti, le piazze, le porte e i velari, i ponti, i palazzi, le case, i giardini: architetture di Giancarlo Leoncilli Massi* (Mantua: Casa del Mantegna, 1988), pp. 57–58. Translated by the author.

26 Leoncilli's sketches for the exhibition are contained in: *Ibid.*, pp. 44–45.

27 In the presentation of the exhibition in *Domus*, Marco Dezzi Bardeschi, describing Leoncilli's project, quotes Giulio Camillo's *Teatro della memoria* and Robert Fludd's *Ars Memoriae*. See Marco Dezzi Bardeschi, "Venezia e lo spazio scenico," *Domus*, no. 602 (1980): p. 8.

28 "The layout of Palazzo Grassi and the three periaets are the only pieces that it has been possible to make from the original project by Gian Carlo Leoncilli. Significant points were the *Labirinto* or *La macchina del teatro* in Saint Mark's Square (gazing across at Rossi's *Teatro*) and the gilded intrados of the Rialto bridge," see *Ibid.*

29 Leoncilli's drawings were made from 1:5000 to 1:25 scale, passing via a 1:200 scale to explain technical details and the precise location of the modules in the chosen areas.



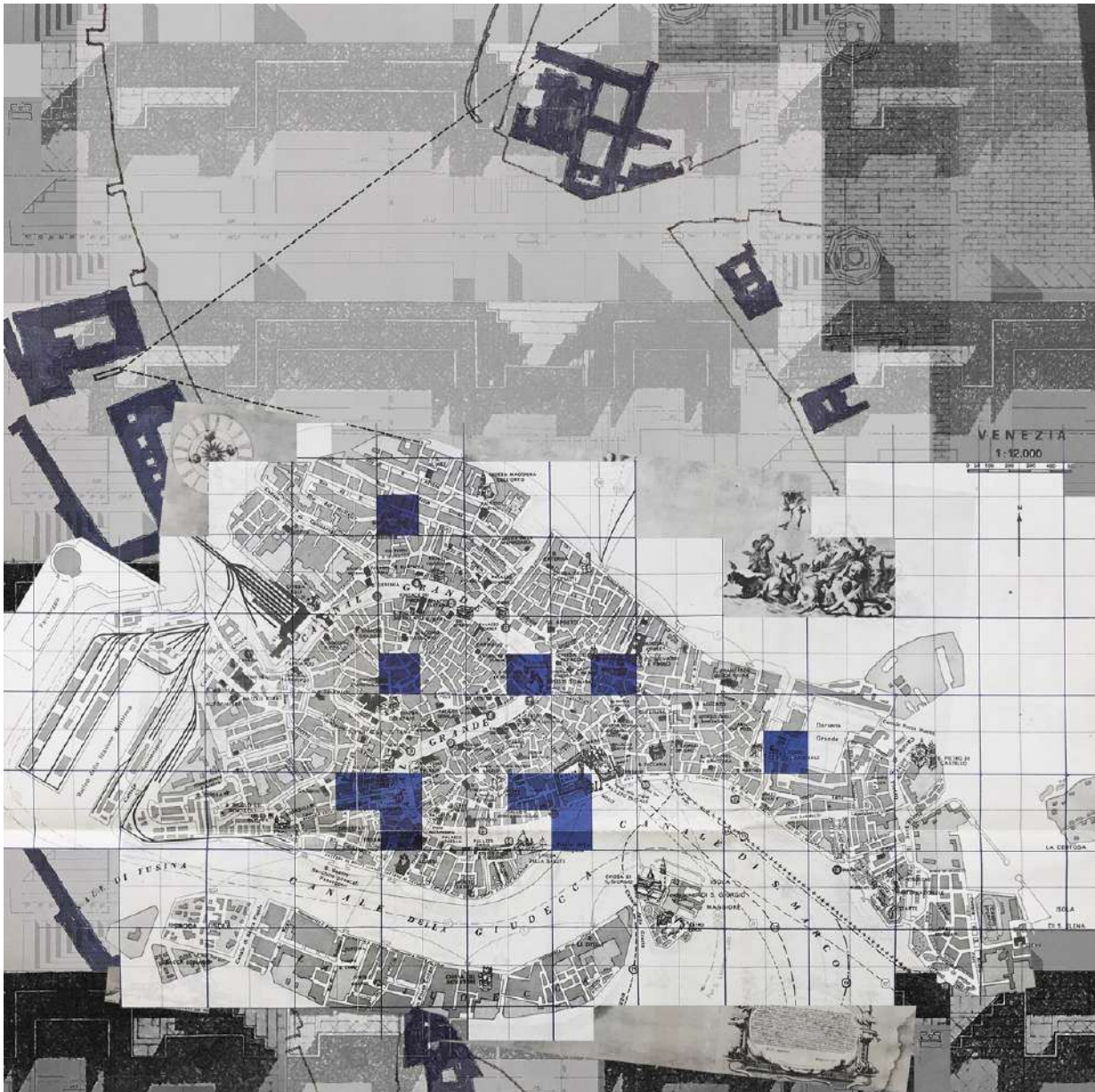

FIG. 4 Montage edited by the author including: an historic map of Venice (Ludovico Ughi, 1729) superimposed on the 200 square-meter grid; map of contemporary Venice (1979) showing the blue squares for which the ephemeral architecture project is proposed.

of the architectural plan – the basic exhibition module to be set up in its dimensional and formal variations at the chosen sites, in addition to the distinctive elements for Saint Mark's Square, the Accademia di Belle Arti and the Rialto bridge:<sup>30</sup> this is the *periaktoi* seen as an ephemeral scenic space.

It is difficult to separate the compositional reading of this project from the chapter entitled *Il gradino muschiato*,<sup>31</sup> written by Guglielmo Bilancioni and inserted in the theoretical part of the official exhibition catalog:

30 See the brief description of the project in: Gian Carlo Leoncilli Massi, "Il sogno, La favola, La ragione e il reale: temi per due progetti veneziani," *La nuova città*, no. 2 (1996): pp. 24–29.

31 Guglielmo Bilancioni, "Tenore di verità nella festa veneziana," in *Venezia e lo spazio scenico* (Venice: the Venice Biennale, 1980), pp. 69–70.



FIG. 5 Volumetric abstraction of a single module of a periaktos as it is taken from the drawings by Leoncilli related to the exhibition of "Venezia e lo spazio scenico" (1979). Concrete maquette made by the author, scale 1:50. Photographer: Umberto Ferro, Laboratorio fotografico (Labfot) luav

The geometry of the vortex, a theory of the abyss, the step, mark the existence of the omnivorous belly [...] the ground of stilt houses stuck [...].<sup>32</sup>

The *periaktos* [Fig. 5] are ephemeral scenic pieces of architecture reflecting an obsession with the step and its various archetypal meanings: stone, stylobate, or the seat of an urban *cavea*. The twenty-five-centimeter-high step reaches its highest height where a small stage allows the speaker to address the public from a podium. The system of steps pivots on the vertical plane to define the image of a stage perceived by successive folds; the interior is golden. The significant event<sup>33</sup> for Leoncilli's project coincided with the narration of the step: the latter archetype reinterpreted in a Venetian key became a compositional means for a scenic representation of the scenography; the recognition of the scenic value of Venice derived from a historiographic analysis of particular rites and customs which historically involved the same twelve sites identified by Leoncilli. Historical memory was added to the scenic value of the built surfaces, which shone through the quality of the scenic backdrops overlooking the *calli* (streets), *campi* (squares) and intricate textures of the public land.

32 Ibid., 70.

33 Rossi, *A Scientific Autobiography*, p. 48.



FIG. 6 Model of the double module as it is taken from the drawings by Gian Carlo Leoncilli Massi, related to the exhibition of "Venezia e lo spazio scenico" (1979), model in painted cardboard made by the author, scale 1:20. Photographer: Umberto Ferro, Laboratorio fotografico (Labfot) luav.

A fenced-in urban theater, constituted by the stairs marking the boat docking places and those of the bridge, assumed a leading role [Fig. 7]. Thus, the exhibition was built by the *periaktos* and offered to the spontaneous desire of tourists and citizens alike who could be the audience or actors of shows, concerts, and *divertissements*. The basic module was doubled or quadrupled in accordance with the dimensions of the available urban space, through iterative operations of dimensional multiplication. The *periaktos* of Leoncilli were designed for *Campo San Barnaba and Ponte dei Pugni, Campo dell'Arsenale, Campo del Ghetto Novo, Campiello della Scuola di S. Giovanni Evangelista, Campo San Samuele, Campo San Fantin, Campo di San Giovanni e Paolo*. In the San Fantin square, the quadruple module was juxtaposed with the staircase leading to "La Fenice" with a forty-five-degree slope in a continuous vision of horizontal planes at different heights [Fig. 6]. In this case, the installation of the module enhanced the visual potency of the existing staircase by duplicating it. In other cases, the *periaktos* had the precise function of framing precious prospects, like optical machinery directing the view [Fig. 8].

In *Campo dell'Arsenale*, the three modules gazed at the two towers and the monumental portal. This set-up was repeated both in the square of the *Scuola Grande di San Giovanni Evangelista*, where two small modules peeked through the perforated wall, and at *Campo San Samuele*, where the modules looked towards *Ca' Rezzonico* beyond the Grand Canal. In the

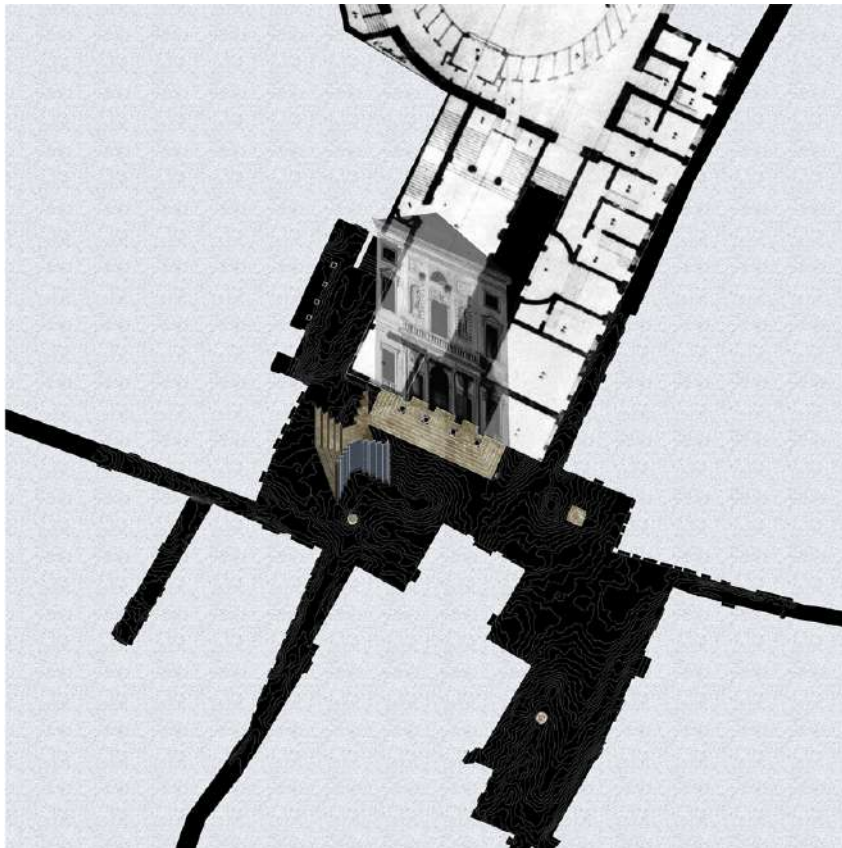

FIG. 7 Campo San Fantin, axonometry with insertion of the quadruple module. Drawing and montage edited by the author, scale 1:200

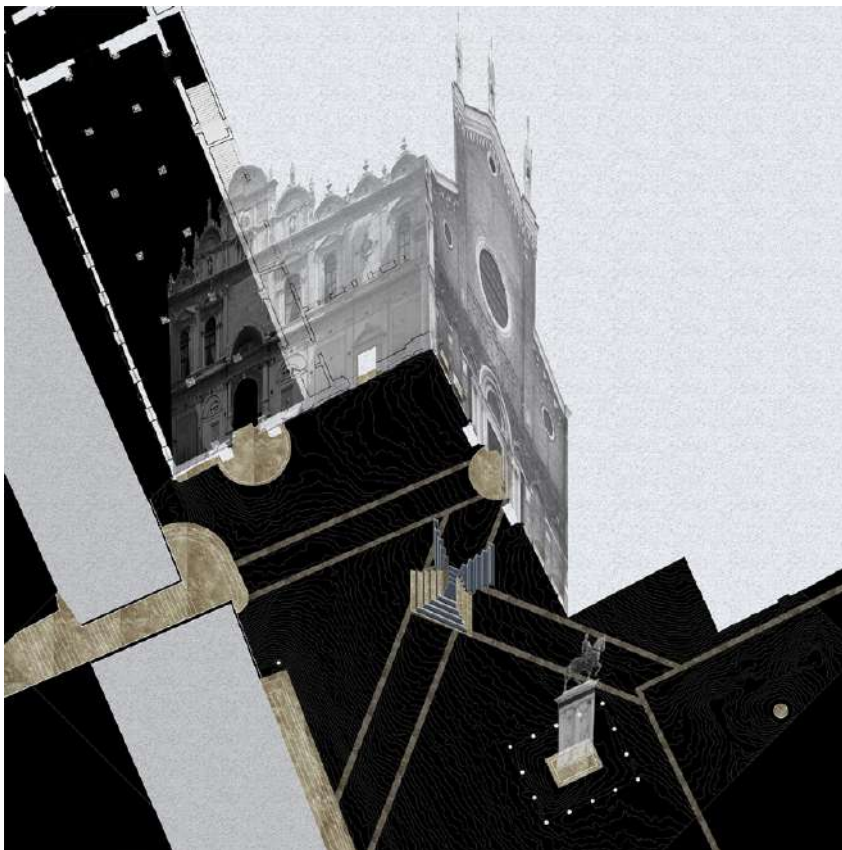

FIG. 8 Campo di San Giovanni e Paolo, axonometry with insertion of the quadruple module. Drawing and montage edited by the author, scale 1:200

latter case, the public space of *Campo San Samuele* could be considered a complementary open-air exhibition pavilion linked to the large square courtyard of *Palazzo Grassi*. In addition, the montage analysis introduced a “telluric” principle which aimed to clarify the installation of certain modules. The term “telluric” here indicated a precise desire to respect the morphology of the pavement by documenting its variations/differences in height. For example, in *Campo di San Giovanni e Paolo* [Fig. 7] the quadruple element was positioned where the white limestone lines intertwined with those leading from the great dock on the canal to the church entrance. In the Ghetto square, the quadruple and double modules were located at the southern and northern entrances to the island, gazing at each other through the trees and the three wells. Leoncilli’s project, only partially realized, sees full expression in the numerous authored drawings kept in the collection of the IUAV Projects Archive.<sup>34</sup> Looking at the proportions and modules in the drawings, the spatial features of the project—which did not garner critical success nor spark debate—achieved great consistency.

### The fourth Act of Strada Novissima

If the exhibition by Leoncilli respected the three acts—introduced earlier as “setting up,” “displaying” and “dismantling”—the case of *Strada Novissima* brings us to the introduction of the “fourth act”: the “rearrangement.” Other ambitious architectural projects, aiming to define the new use of the ephemeral,<sup>35</sup> were launched after the *Venezia e lo spazio scenico* exhibition. In this regard, it is worth recalling the exhibition of the event called *The Carnival of the Theater*<sup>36</sup> (1980) and promoted by the Biennale Theater sector under the curatorship of Maurizio Scaparro. On that unique occasion, the carnival theme completely transformed the historical city center into a sequence of outdoor theaters, and improvised performances took place with the aid of scenographic and choreographic installations, including the “cobweb” of Donato Sartori<sup>37</sup> which occupied the entire space of Saint Mark’s Square. The set-up of *Strada Novissima* could be interpreted as a consequence of these events just described, among many others. By interpreting the project with a subtle sense of humor and without relying on post-modernist language preconceptions, *Strada Novissima* sealed the success of the Venice Biennale as an institution at the forefront of the international debate on the theme of setting up architectural exhibitions. As Portoghesi highlighted, new problems concerning the lack of an authentic narration of Venice —let down by poor advertising—and mere

34 Project Archive: *Venezia e lo spazio scenico* (1979); location: box 20; shelf mark: BIAP/3/7.

35 Portoghesi and Scaparro, “Venezia e lo spazio scenico.”

36 Dario Ventimiglia, *Il carnevale del teatro* (Venice: The Venice Biennale, 1984).

37 Donato Sartori and Paola Pizzi, *Maschere e mascheramenti. I Sartori tra arte e teatro* (Padua: Il Poligrafo, 1996).

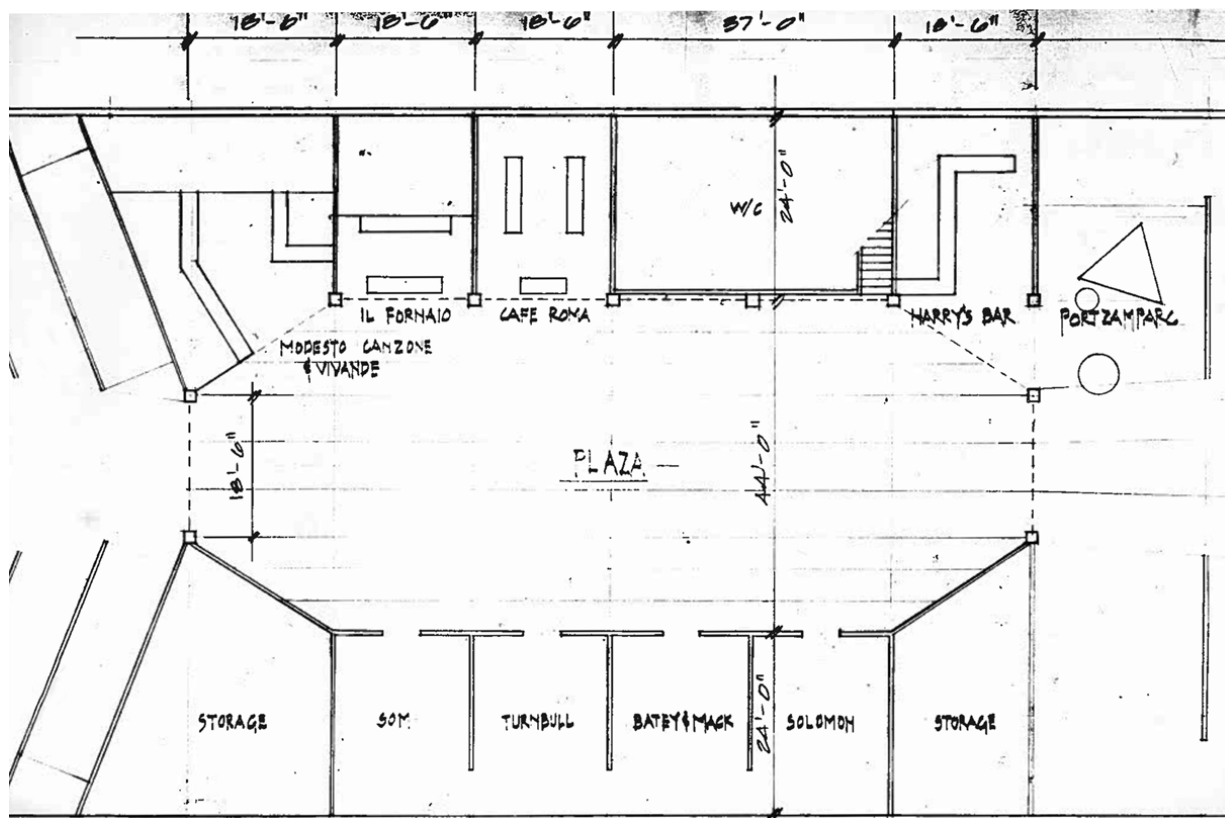

FIG. 9 "The Plaza," original planimetric drawing referring to the rearrangement of "Strada novissima" for "The Presence of the Past" exhibition held in San Francisco (1982). ©The Presence of the Past, Jr./MLTW Collection, 1959-1997, Environmental Design Archive.

architectural self-representation<sup>38</sup> arose together with the success of the 1980 Biennale. That aside, *La presenza de l'histoire* in Paris (Chapelle Saint-Louis de la Salpêtrière) in 1981 and *The Presence of the Past* in San Francisco (Fort Mason Center) in 1982<sup>39</sup> for the first time raised the question of what their rearrangements meant. The problem is to mediate between the Venetian nature of the Biennale in each of its installations and the emerging international vocation of its staging.<sup>40</sup> The case of *Strada Novissima*, which is dealt with here in its revised meaning from the 1982 Californian exhibition,<sup>41</sup> was an experiment that aimed to transpose an aspect of Venice's nature overseas by means of the rearrangement technique. Whereas the location had changed, Venice's nature remained, together with the same design principles of the original set-up: an ephemeral work of architecture composed in a void, named *Plaza* similar to the urban scenography designed by Vincenzo Scamozzi for the *Teatro Olimpico* of Palladio in Vicenza. The exhibition site plan of the

38 Claudio D'Amato, *Studiare l'architettura: un vademecum e un dialogo* (Rome: Gangemi, 2014), p. 134.

39 The two events were curated for the *Salon d'Automne* (the 1981 Parisian edition) and a group of cultural institutions for the 1982 Californian edition involving: the SFMOMA, the San Francisco Italian Cultural Institute, the association *Friends of the Biennale and the Fort Mason Center* (Museum of Contemporary Art).

40 Paolo Portoghesi, *The Projectual Offer* (Venice: The Venice Biennale, 1985), 10–11.

41 Léa-Catherine Szacka, *Exhibiting the Postmodern: The 1980 Venice Architecture Biennale* (Venice: Marsilio, 2016).



to re-propose the Venetian linearity. There were two ways to intervene in the rearrangement: reinterpretation and forced revival. It is interesting to note that the *Teatro del Mondo* and *Strada Novissima* would meet again in the San Francisco bay<sup>42</sup> during the Californian edition of *The Presence of the Past*: an encounter which would have been impossible in Venice that only bestowed additional power upon the rearrangement. There are many examples of reports relating the desire to rebuild the floating theater in the bay. The heavy swell of the ocean made it necessary to re-build the theater on "bare rock."<sup>43</sup> At this point, it is useful to again mention the events<sup>44</sup> that Aldo Rossi referred to, in order to define architecture, theater, and city. *The Teatro del Mondo* cyclically appeared in several design sketches outside Venice, probably more than any other ephemeral architecture produced by Rossi. For this reason, the desire to rebuild the theater in San Francisco was perfectly coherent. A similar outlook can be seen in a sketch for the *New Architecture School of Miami University*,<sup>45</sup> where the theater, no longer floating, rests on an actual pier [Fig. 10].

The theater is fed by the memories of the place it lives in, restoring a precise Venetian nature, even though it is set elsewhere: it can be considered akin to the *Theatrum orbi* of Robert Fludd.<sup>46</sup>

## Conclusion

The urban ephemeral architecture project brings out new issues regarding the place where it is taking place. If it receives the honor of the "fourth act," its structure must necessarily change, overwriting new memories deriving from the new exhibition site. These projects are working tools for memory and remembrance: narrative projects that have the power to strengthen the link between the project itself and the place; indeed, this can even have a practical value in identifying and enhancing the construction and cultural characteristics of a given environment. This same power of evocation allows a glimpse of a militant goal in this category of architectural project. Assigning a scenic, theatrical and mnemonic responsibility to the project helps to understand its potential in terms of a "regeneration of urban memory" or an "evocation of urban memory." Whereas the theoretical/practical discussion on the topic of urban regeneration seems to be inextricably linked to the concept of the mere reuse of abandoned spaces,

42 The archive documents are owned by the *Environmental Design Archive* of Berkeley University (EDA). The most interesting research materials have been transferred to the archive by William Turnbull (*Jr./MLTW Collection*, 1959–1997); collection number: 2000–9.

43 Information taken from correspondence dated 1982 between *Friends of the Biennale and Fort Mason*. William Turnbull Archive (*Jr./MLTW Collection*, 1959–1997); EDA, collection number: 2000-9.

44 Rossi, *A Scientific Autobiography*, p. 48.

45 See the design proposal for the *Miami New School of Architecture* (1986) and see also "Aldo Rossi makes his American debut (School of Architecture of Miami, Florida)," *Architectural Record* 175 (1987): p. 67.

46 Robert Fludd, *Utriusque cosmi maioris scilicet et minoris metaphysica, physica atque technica historia* (Oppenheimii: Hieronymi Galleri, 1617).



it is enlightening that in the German context the concept of urban regeneration is increasingly bound to the term *Zwischennutzung*<sup>47</sup> translatable as “temporary use.” Temporary use is one of the means to use urban spaces that are awaiting a project. The exhibition is one of the triggers of temporary use and must propose models and helpful thoughts for the construction of the city, while recognizing the prevailing culture of the times. Hence, ephemeral architecture reacquires its potential urban role which is to overcome its ambiguous nature of being considered a mere display.<sup>48</sup>

---

47 Philipp Oswald, Klaus Overmeyer, and Philipp Misselwitz, eds., *Urban Catalyst: The Power of Temporary Use* (Berlin: DOM publishers, 2013).

48 Eeva-Liisa Pelkonen, Carson Chan, and David Andrew Tasman, eds., *Exhibiting Architecture: A Paradox?* (New Haven: Yale School of Architecture, 2015).



## References

- Argan, Giulio Carlo, and Christian Norberg-Schulz. *Roma interrotta*. Rome: Officina Edizioni, 1978.
- Brusatin, Manlio. *Venezia e lo spazio scenico*. Venice: The Venice Biennale, 1980.
- Camillo, Giulio. *L'idea del teatro*, edited by Lina Bolzoni. L'Italia 02. Palermo: Sellerio Editore, 1991.
- Cattiodoro, Silvia. *Architettura scenica e teatro urbano*. Milan: FrancoAngeli, 2007.
- Conte, Gian Biagio, Emilio Pianezzola, and Giuliano Ranucci. "Ephemerus." In *Il Latino. Vocabolario della lingua latina*, 461. Milan: Le Monnier, 2010.
- Dal Co, Francesco. *10 immagini per Venezia*. Rome: Officina edizioni, 1980.
- D'Amato, Claudio. *Studiare l'architettura: un vademecum e un dialogo*. Rome: Gangemi, 2014.
- Dezzi Bardeschi, Marco. "Venezia e lo spazio scenico." *Domus*, no. 602 (1980): p. 8.
- Ferlenga, Alberto. *Aldo Rossi: tutte le opere*. Milan: Electa, 2000.
- Ferrucci, Fabio. *L'arte della memoria di Giordano Bruno. Il trattato «De umbris idearum» rivisto dal noto esperto di scienza della memoria*. Milan: Anima, 2005.
- Fludd, Robert. *Utriusque cosmi maioris scilicet et minoris metaphysica, physica atque technica historia*. Oppenheimii: Hieronymi Galleri, 1617.
- Guy, Michel, Giuseppe Galasso, Monique Mosser, and Paolo Portoghesi. *L'après Modernisme: La Présence de l'histoire: Festival d'automne à Paris, La Biennal Di Venezia*. Paris: L'Équerre, 1981.
- Halbwachs, Maurice, and Lewis A. Coser. *On Collective Memory*. The Heritage of Sociology. Chicago: University of Chicago Press, 1992.
- Lacan, Jacques. *The Four Fundamental Concepts of Psychoanalysis*. London: Routledge, 2018.  
<https://doi.org/10.4324/9780429481826>
- Leoncilli Massi, Gian Carlo. "Il sogno, la favola, la ragione e Il reale: temi per due progetti veneziani." *La nuova città*, no. 2 (1996): pp. 24–29.
- . *La composizione commentari*. Venice: Marsilio, 1986.
- . *La leggenda del comporre*. Florence: Alinea, 2002.
- . *L'etrusco torna a scrivere*. Florence: Alinea, 1997.
- Leoncilli Massi, Gian Carlo, Giovanni Fraziano, Aldo Rossi. *I labirinti, le piazze, le porte e i velari, i ponti, i palazzi, le case, i giardini: architetture di Giancarlo Leoncilli Massi: 6 February - 6 March 1988*. Mantua: Casa del Mantegna, 1988.
- Levy, Aaron, and William Menking. *Architecture on Display: On the History of the Venice Biennale of Architecture*. London: AA Publications, 2010.
- Nicolini, Renato. *Estate romana*. Siena: Sisifo, 1991.
- . *Estate romana: 1976-85: un effimero lungo nove anni*. Reggio Calabria: Città del Sole, 2011.
- Occhipinti, Chiara. *Intorno ad Aldo Rossi e alla sua Architettura*. Milan: Politecnico di Milano, 2013.
- Oswalt, Philipp, Klaus Overmeyer, and Philipp Misselwitz, eds. *Urban Catalyst: The Power of Temporary Use*. Berlin: DOM publishers, 2013.

Pelkonen, Eeva-Liisa, Carson Chan, and David Andrew Tasman, eds. *Exhibiting Architecture: A Paradox?* New Haven: Yale School of Architecture, 2015.

Portoghesi, Paolo. *Terza Mostra Internazionale Di Architettura: Progetto Venezia/The Venice Biennale*. Venice: The Venice Biennale, 1985.

Rossi, Aldo. *Autobiografia scientifica*. Nuovi Saggi. Parma: Pratiche Editrice, 1990.

———. "La città analoga." *Lotus*, no. 13 (1976): pp. 4–7.

———. *L'architettura della città*. Padua: Marsilio, 1966.

Sartori, Donato, and Paola Pizzi. *Maschere e mascheramenti. I Sartori tra arte e teatro*. Padua: Il Poligrafo, 1996.

Serlio, Sebastiano. *Tutte l'opere d'architettura di Sebastiano Serlio, Bolognese: dove si trattano in disegno, quelle cose, che sono più necessarie all'architetto*. Venice: Francesco de Franceschi Senese, 1584.

Szacka, Léa-Catherine. *Exhibiting the Postmodern: The 1980 Venice Architecture Biennale*. Venice: Marsilio, 2016.

Tafuri, Manfredo. "Ceci n'est pas une ville." *Lotus*, no. 13 (1976): pp. 8–10.

———. "L'éphémère est éternel: Aldo Rossi a Venezia." *Domus*, no. 602 (1980): pp. 7–12.

Ventimiglia, Dario. *Il carnevale del teatro*. Venice: The Venice Biennale, 1984.

Yates, Frances A. *The Art of Memory*. Chicago: University of Chicago Press, 1966.

Zorzi, Ludovico. *Il teatro e la città: saggi sulla scena italiana*. Turin: Einaudi, 1977.

———. "Intorno allo spazio scenico veneziano." In *Venezia e lo spazio scenico*, edited by Manlio Brusatin, pp. 81–109. Venice: The Venice Biennale, 1980.



EUROPEAN JOURNAL OF  
CREATIVE PRACTICES  
IN CITIES AND LANDSCAPES

## MAIN SECTION

# Surrealist Curation: Urban Domesticity through the Surrealist Poetics of Analogy

Ke Sun – University of Florida (United States) – Contact: [ksun2014@ufl.edu](mailto:ksun2014@ufl.edu)

## ABSTRACT

The tactic of surrealist poetic analogy forms the surrealist curation that functions as an agent that occupies, engages, and ultimately transforms the city and its built environment that surrounds us. In the case of Le Corbusier's roof terrace of the Beistegui apartment in Paris, Le Corbusier uses intentional movements and visual analogical compositions to dictate a curated urban experience in a domestic space. The surrealist curation unfolds the tenacious relationship between house and city through an analogical narrative, in which the house extends its boundaries to the public realm and brings domesticity into the city. In the case of Aljys' Modern Procession in New York City, the carried art objects, the music performed during the procession, and the movements of the participants domesticate urban streets by relocating art objects from the interior of a private museum institution to the public urban space. The juxtaposed urban elements enact a poetic transformation that facilitates the surrealist curation to assemble an "oneiric house" filled with fantasy. The paper argues that the surrealist curation evokes "dream images" in the city that transcends the tangible material city into a dream entity and looks beyond the built environment to understand the city. By implementing the surrealist curation one can further challenge the perceptions of urban spatial boundaries and investigate the theoretical and historical overlaps between urban domesticity and surrealist imagination. Surrealist curation criticizes the homogenous quantitative treatments of urbanism and their analytical data-driven approaches to urban transformation, calls for the examination of poetic relationships in our cities through visual fantasies, corporeal kinesthesia, and alternative narratives of reveries.

## KEYWORDS

*Surrealist Curation; Urban Domesticity; Urban Space; Architectural Surrealism; Poetic Analogy*

## PEER REVIEWED

<https://doi.org/10.6092/issn.2612-0496/10156>

ISSN 2612-0496

Copyright © 2020 Ke Sun



## Introduction: Surrealist Curation

An individual's experience of the city is innately "fragmentary, episodic and partial," and the mind reads these moments by curating the experiences in "historical sequences" and reframing them in reminiscences.<sup>1</sup> The experience of urban space thus necessarily calls upon curated urban images from one's memory, imagination, and fantasy. The dynamic perception of urban space is framed through narrated visual images and kinesthetic bodily experiences. In the *Dialectics of Seeing*, Susan Buck-Morss argues that "dream images" demonstrate interchangeability with material "urban objects," which are "hieroglyphic clues" to the memory of urban space.<sup>2</sup> She then describes how Walter Benjamin's memory of the urban space of Berlin, resides in his unconsciousness and presides over his imagination. For Benjamin, the personal experience of the city folds into dreams through urban images, which is simultaneously assembled with individual imagination and collective memory.<sup>3</sup> Therefore, one curates the city with recourse to urban images by dissecting the physical urban fabric into fragmented memories and reconstructing them with oneiric imagination. I contend that the city acts as "a fictional starting point"<sup>4</sup> in the process of forming urban images and yields situations enacted between inhabitants, through their limitless imagination and collective consciousness, and urban architecture. The oneiric urban images operate as tools for a personal curation of urban space and function as mediators between the physical built environment and the imagined psychic world. This curation of urban space offers an alternative understanding of the city through urban images that transcends its urban space beyond palpable materiality. Through such curation, the ephemeral urban experience manifests itself within the material world.

The following theories continue the investigation of this urban curation through the lens of the complex relationship between city, imagination, and language. It then frames the curation in surrealist theory that examines poetics and analogies. For architectural historian, Dalibor Veselý, dream entails the ability to transform "conventional reality" into "fantastic reality" and is infinitely poetic.<sup>5</sup> Thus, the poetic experience channels the illuminated dream world that harbors imagination. Architectural historian Alberto Pérez-Gómez attributes the emergence of the poetic image to the seemingly "paradoxical and contradictory operation" by which all art is created and claims that the ultimate cognitive function of the

---

1 Sarah Chaplin and Alexandra Stara, eds., *Curating Architecture and the City* (New York and London: Routledge, 2009), 39.

2 Susan Buck-Morss, *The Dialectics of Seeing: Walter Benjamin and the Arcades Project* (Cambridge, MA: MIT Press, 1991), 39.

3 Ibid, 38.

4 Anthony Vidler, *The Architectural Uncanny: Essays in the Modern Unhomely* (Cambridge, MA: MIT Press, 1992), 204.

5 Dalibor Veselý, "Surrealism and the Latent World of Creativity," *Umeni / Art* 59, no. 3/4 (June 2011): 267.

poetic image becomes an openness to mystery that introduces new experiences.<sup>6</sup> The association between consciousness and the poetics proves that the curated urban images can reinvent the city through a poetic linguistic horizon that connotes the meanings of individual urban experiences. For philosopher Michel Foucault, an analogy is endowed with “a universal field of application” through which all figures in the whole universe can be drawn together and the space occupied by analogies is essentially “a space of radiation.”<sup>7</sup>

Foucault’s “radiation” resonates with the surrealist “spark” of juxtaposed images discussed in André Breton’s *Manifesto of Surrealism*. Breton states that the “surrealist” emerges from “simultaneous products of the activity” (*les produits simultanés de l’activité*) that spark a “luminous phenomenon” (*le phénomène lumineux*) from distinct realities.<sup>8</sup> The curation of urban experience traces a memory path that consists of dichotomous and distinct individual urban moments. Breton’s novel *Nadja* juxtaposes texts and photographs of Paris in a curatorial narrative that connects the reader with urban images through a psychological experience. These surrealist arrangements of urban images entail a “curatorial practice” that coordinates images and texts based on their relationship to a system of meaning.<sup>9</sup> One can then discover the innate connection between the curation of urban experiences and the analogically juxtaposed urban situations that embody poetic meanings. Veselý argues that “the analogical image which illuminates partial similarities” refuses to be reduced into a simple equation; and “it moves and mediates between two different realities present in a way which is never reversible.”<sup>10</sup> He further combines the notion of poetics and the concept of the analogy of surrealist practice and theorizes it into a “surrealist poetic analogy.”<sup>11</sup> Therefore, the curation of experiences through urban images indicates a surrealist characteristic that intrinsically folds meanings into poetic language and reverberates imagination through analogical reading. I argue that this tactic of surrealist poetic analogy forms a surrealist curation.

This paper studies the practice of surrealist curation in both Le Corbusier’s Beistegui apartment, located at 136 Avenue des Champs-Élysée in Paris (1929 to 1931) and Francis Alÿs’s *The Modern Procession* in New York City (2002). Although the two distinct productions are from different cities and periods, both of them have intentionally curated experiences in the city through the language of poetics and analogies. The former operates

---

6 Alberto Pérez-Gómez, *Attunement: Architectural Meaning After the Crisis of Modern Science* (Cambridge, MA: MIT Press, 2016), 174.

7 Michel Foucault, *The Order of Things: An Archaeology of the Human Sciences* (New York and London: Routledge, 2002), 22-23.

8 André Breton, *Manifestoes of Surrealism* (Ann Arbor: University of Michigan Press, 1969), 37; André Breton, *Manifestes du surréalisme* (Paris, France: Jean-Jacques Pauvert, 1962), 53.

9 Chaplin and Stara, *Curating Architecture and the City*, 42.

10 Veselý, “Surrealism and the Latent World of Creativity,” 268.

11 Ibid.

within the private, domestic realm while the latter takes place in the public realm. By connecting and comparing the two cases, the paper sets out to understand how the agency of poetic analogy mediates between the two realms and further explains how domesticity plays a role in the surrealist curation. It argues that the surrealist curation offers an exodus of urban transformation from tangible physical operations to a surrealist imagination.

The surrealist curation functions as an agency that occupies, engages, and ultimately transforms the city and its built environment that surrounds us. To curate urban experiences, it requires a form of inhabitation, which manifests through walking and kinesthetic bodily movements that occupy the urban environment. To engage the city, the surrealist curation elevates the corporeal movement to a perceptual field and builds oneiric urban images through one's recollections and begets an imagined city. From the imagined city, the surrealist curation uses the analogical urban images to imbue the city with transcendent meanings that change the identity of urban space. It ultimately transforms urban space through newly curated perceptions that operate in both private and public domains.

The exchange between the private, domestic sphere and the public, urban sphere divulges domesticity in surrealist curation. In the case of the rooftop terrace of the Beistegui apartment in Paris, Le Corbusier uses intentional movements and visual analogical compositions to dictate a curated urban experience in a domestic space. The co-presence and transformation between the paradoxical senses of exteriority and interiority in Le Corbusier's design of the rooftop terrace exemplify the tactic of surrealist poetic analogy. It brings intimate domesticity into the expansive city and transfers the public urban space of Paris into private domestic territories. In the case of Alijs' Modern Procession in New York City, the carried art objects, the music performed during the procession, and the movements of the participants, domesticate urban streets by relocating art objects from the interior of a private museum institution to the public urban space. The movement of the procession brings the participants into a transcendent state between dreams and reality. It serves to transform the urban space into a mnemonic landscape of façades, objects, bodies, movements, and disparate urban objects that yield a surrealist phenomenon of *objet trouvé*, a surreal encounter initiated by the "projection of desire" into the "phantom-like image" and found objects.<sup>12</sup> In this last case, the juxtaposed urban elements enact a poetic transformation that facilitates the surrealist curation to assemble an "oneiric house" filled with fantasy. The notion of the "oneiric house" coined by Gaston Bachelard, is furthered by Veselý, who describes it as a "surrealist paradigm" that evokes "cosmic images" and excurses through the realm of dreams and fantasy.<sup>13</sup>

---

12 Ibid.

13 Ibid, 271.



The Modern Procession brings institutionalized surrealist artworks, which are traditionally curated in domestic galleries, to the public “oneiric house” and curates an urban situation that encompasses surrealist analogies. This public “urban house” shelters reveries of individual participants in the public realm and thus, composes a poetic analogy of domesticity in the urban sphere. The paper examines this resultant of the transformative surrealist curation and defines it as urban domesticity.

Surrealist curation carefully reinvents the world with formal relationships through the organization of poetic language. It exceeds instances of individual reclusiveness to embrace the collective sphere of publicness. By putting into practice the analogical intervention of poetic images, in the case of Le Corbusier’s Beistegui apartment, the surrealist curation unpacks the tenacious relationship between house and city through an urban narrative, in which the house extends its boundaries to the public realm and brings domesticity into the city; and in the case of Alÿs’ Modern Procession, the surrealist curation juxtaposes the human bodies and art objects in the city to transform the public sphere into a domestic domain, constructing a metaphorical “house” in the city. Consequently, the paper argues that the surrealist curation evokes “dream images” in the city that transcends the tangible material city into a dream entity and looks beyond the built environment to understand the city. By implementing surrealist curation one can further challenge the perceptions of urban spatial boundaries and investigate the theoretical and historical overlaps between urban domesticity and surrealist imagination. Surrealist curation criticizes the homogenous quantitative treatments of urbanism and their analytical data-driven approaches to urban transformation, such as urban studies that emphasize sustainability, ecology, aesthetics, and transportation exclusively from scientific methods and technological perspective that forgo the human narratives. Surrealist curation calls for the examination of poetic relationships in our cities through visual fantasies, corporeal kinesthesia, and alternative narratives of reveries.

## **Domesticity and Surrealism: House, Dream, City**

The relationship between domesticity and surrealism builds a theoretical framework for surrealist curation. This framework comes out of the interplay between house, dream, and city. It interrogates how the surrealist imagination of house and dream induces domesticity and discovers how the surrealist “dream house” further domesticates the city.

Surrealism investigates the connection between house and dream in wider theoretical arguments. Vesely believes that the intimate space in which the realm of the surrealists is situated can be visualized as a private domain of a house.<sup>14</sup> He then argues in his discussions of surrealism

---

14 Ibid.

and architecture that the house is a symbol of the “latent experience” and a metaphor for “surrealist creativity,” which represents a paradigm that offers endless imagination in the “poetics of surrealism.”<sup>15</sup> By analyzing André Breton’s poem *La Maison d’Yves*, Vesely describes the house as “a perilous domain of the unknown and dreams,” in which the finite interior confines the infinite imagination in “a structure of the unconscious world.”<sup>16</sup> Breton dreams of a house that is a “castle” not far from Paris in “a rustic setting,” (*un site agreste*) half of which is “not necessarily in ruins” where he invites surrealist intellectuals as permanent guests.<sup>17</sup> He challenges the assumption that the house he dreams of is a mere image, by arguing that the “whim of his guests” is the “luminous road” (*la route lumineuse*) that leads to it.<sup>18</sup> The “castle” is a house that incites fantasies and shelters surrealist illuminations under its domestic sphere.

In surrealist theory, the house harbors dreams and defines their interiority by containing them with physical boundaries; dreams dwell in houses and occupy the finite domestic space with infinite imagination. The relationship between house and dream operates as a surrealist agency that demarcates the domestic sphere. The connection of house and dream to domesticity is furthered by Walter Benjamin. In “One-Way Street” Benjamin describes the threshold between dreaming and waking with a metaphor of the breakfast room in the house and argues that “the one who avoids a rupture between the nocturnal and the daytime” cultivates a dream world in the house.<sup>19</sup> For Benjamin, the domestic space functions as a liminal threshold between dream and reality, in which the ritual of breaking fast ruptures the two worlds, and in order to maintain a connection with the dream world, one avoids the morning meal. The domestic sphere connects the consciousness of dreaming to the built interior of a house and brings interiority to the private ritual of dreaming. For Robert Pogue Harrison, a house humanly preserves our “vital heat” from the “insideness.”<sup>20</sup> This preservation of “insideness” also implies that a house converts exteriority to interiority by environing our memories and dreams. From the arguments above, one can infer that surrealism reduces the world to a domestic domain of house and dream through imagination and environs the dream with domesticity.

---

15 Ibid, 269-72.

16 Ibid, 269.

17 Breton, *Manifestoes of Surrealism*, 16-17.

18 Ibid, 18; Breton, *Manifestes du surréalisme*, 31. Here the “*la route lumineuse*” reverberates with the surrealist “*le phénomène lumineux*” (the luminous phenomenon).

19 Walter Benjamin, *Reflections: Essays, Aphorisms, Autobiographical Writings*, ed. Peter Demetz, trans. Edmund Jephcott (New York: Schocken Books, 1978), 62.

20 Robert Pogue Harrison, *The Dominion of the Dead*, (Chicago: University Of Chicago Press, 2003), 42-44.

Benjamin argues that public spaces such as arcades and winter gardens of Paris are “dream houses” for the collective consciousness.<sup>21</sup> For Benjamin, the city of Paris is composed by “dream houses,” in which the domestic ritual of “dreaming” brings collective reveries into the urban space and induces domesticity into the public sphere. Benjamin describes Paris as the most “dreamed-about” object of the surrealist imagination, and he claims that the “surrealists’ Paris” was a “little universe,” whose true face is revealed in the surrealist dream.<sup>22</sup> He remarks that “the dream has no outside” which indicates the interiority of the urban “dream house.”<sup>23</sup> The urban “dream house” is the “dwelling place”<sup>24</sup> for *flâneurs* that retain their collective urban experiences. Therefore, dream houses reinvent the public domain with domestic places and transform the city through domestication.

In conclusion, dream functions as a mediator that exceeds the boundaries between the house and the city and divulges domesticity through the latency of surrealist imagination. This theoretical premise begets an innate surrealist craft of domesticity that folds the surrealist curation in the transformation between house and city.

## Poetic Analogies of Domesticity

Le Corbusier uses rooftop terraces in architecture to foster relationships between the interior and exterior. In Villa Stein, he instills a two-story void into the surrounding nature, framing the foliage into the interior. Architect Alexander Gorlin finds that the terrace of Villa Stein is “reminiscent of the space in surrealist painter René Magritte’s *The Childhood of Icarus* in which a gargantuan room opens to the forest.”<sup>25</sup> In another example, the Villa Savoie vertically separates and juxtaposes the interior and the exterior landscape with the roof garden wall which Gorlin compares to Magritte’s *The Voice of Silence*.<sup>26</sup> Similar to Magritte’s surrealist language of juxtaposition that renders an uncanniness, Le Corbusier brings an uncanny relationship between the interior and the exterior through the surrealist intervention of the rooftop terrace.

Le Corbusier’s affinity toward surrealist practice is deliberately manifested in the roof terrace of the Beistegui apartment. Architectural historian Rostislav Švácha argues that despite the contentious relationship between the Functionalist “dehumanized rationalism” in architecture and

---

21 Walter Benjamin, *The Arcades Project*, trans. Howard Eiland and Kevin McLaughlin (Cambridge, MA: Harvard University Press, 1999), 405.

22 Walter Benjamin, *Walter Benjamin: Selected Writings, Volume 2: 1927-1934*, ed. Michael W. Jennings, Howard Eiland, and Gary Smith (Cambridge, MA: Harvard University Press, 1999), 211.

23 Ibid, 406.

24 Ibid, 17.

25 Alexander Gorlin, “The Ghost in the Machine: Surrealism in the Work of Le Corbusier,” *Perspecta* 18 (1982): 53, <https://doi.org/10.2307/1567035>.

26 Ibid, 55.

the artistic status of Surrealism, Le Corbusier's Beistegui apartment shines a light on surrealist language.<sup>27</sup> The curation of analogical composition in a poetic language guides Le Corbusier's execution of the roof terrace where space plays with the paradoxes of interior and exterior through the juxtaposition of various architectural elements. This intentional analogy is deeply rooted in Le Corbusier's theoretical framework that "the exterior is always an interior," as he has himself stated in *Towards a New Architecture* where he asserts that the human eye is always attracted to "the center of gravity of the whole site" and is constantly moving with the beholder himself through the investigations of the place.<sup>28</sup> He emphasizes that in "architecture ensembles," the elements of the site itself come into play by their "cubic volume," and the density and materiality of the compositions of the site bring definite "sensations."<sup>29</sup> On the roof terrace of Beistegui apartment, the openness of the rooftop and the carpet of grass on the ground imply exteriority and brings a sense of publicness. Paradoxically, the domestic furniture and the fireplace on the back wall present interiority curated with analogical imagination [Fig. 1].



FIG. 1 Le Corbusier's Beistegui Apartment Rooftop Terrace with a Fireplace and the Arc de Triomphe in the Background. Image Credit: © F.L.C. / ADAGP, Paris / Artists Rights Society (ARS), New York 2020

As Veselý's essay suggests, the terrace furnishes a series of "analogical readings" in which the individual elements play the role of metaphorical fragments, revealing an open set of "poetic analogies."<sup>30</sup> This instance of surrealist curation combines elements of the domestic realm with

27 Rostislav Švácha, "Surrealism and Czech Functionalism," trans. Jan Valeška, *Umeni / Art* 55, no. 4 (August 2007): 316.

28 Le Corbusier, *Towards a New Architecture*, Reprint edition (NY: Dover Publications, 1985), 191.

29 Ibid.

30 Veselý, "Surrealism and the Latent World of Creativity," 272.

the outdoors, and in so doing brings domestic fantasies into the city. The perplexing simultaneous interiority and exteriority of the Beistegui apartment posit the house and the city in the surrealist dream world. And the distinction between the inside and outside to urban spaces is blurred. In the Beistegui apartment, the walls of the roof terrace operate as boundaries that demarcate the interior by only allowing fragments of urban monuments, such as the Arc de Triomphe and the Eiffel Tower, to be partially seen [Fig. 2]. The deliberate curation of fragmented urban images of Paris introduces the publicness into a latent surrealist world. These iconic city monuments of Paris bring monumentality into the domestic sphere, and the Beistegui apartment, in turn, domesticates urban monumentality through a curated analogical urban experience.



FIG. 2 Le Corbusier's Beistegui Apartment Rooftop Terrace with a Fireplace and the Eiffel Tower in the Background. Image Credit: © F.L.C. / ADAGP, Paris / Artists Rights Society (ARS), New York 2020

Surrealist curation in Le Corbusier's Beistegui apartment engages the city of Paris through the observers who inhabit the domestic space and introduces a dream house in the city through the assembly of a latent urban fabric that alters domestic inhabitants' perceptions of the boundaries of urban space. Ross Anderson argues that, "for Le Corbusier, Paris possessed an inimitable *'esprit'* that was expressed architecturally in the distinctive profile of the horizon of the city."<sup>31</sup> In a sequence of drawings presented in Buenos Aires in 1929, Le Corbusier articulated the horizon of the city in chronological order from medieval Notre Dame, classical Louvre, and neoclassical Panthéon to modern Paris with the Arc de Triomphe, the Basilique du Sacré Coeur, and the Eiffel Tower.<sup>32</sup> By representing Paris

31 Ross Anderson, "All of Paris, Darkly: Le Corbusier's Beistegui Apartment, 1929-1931" (Le Corbusier, 50 Years Later, Valencia, Spain, 2015): 117, <https://doi.org/10.4995/LC2015.2015.928>.

32 Ibid, 118.

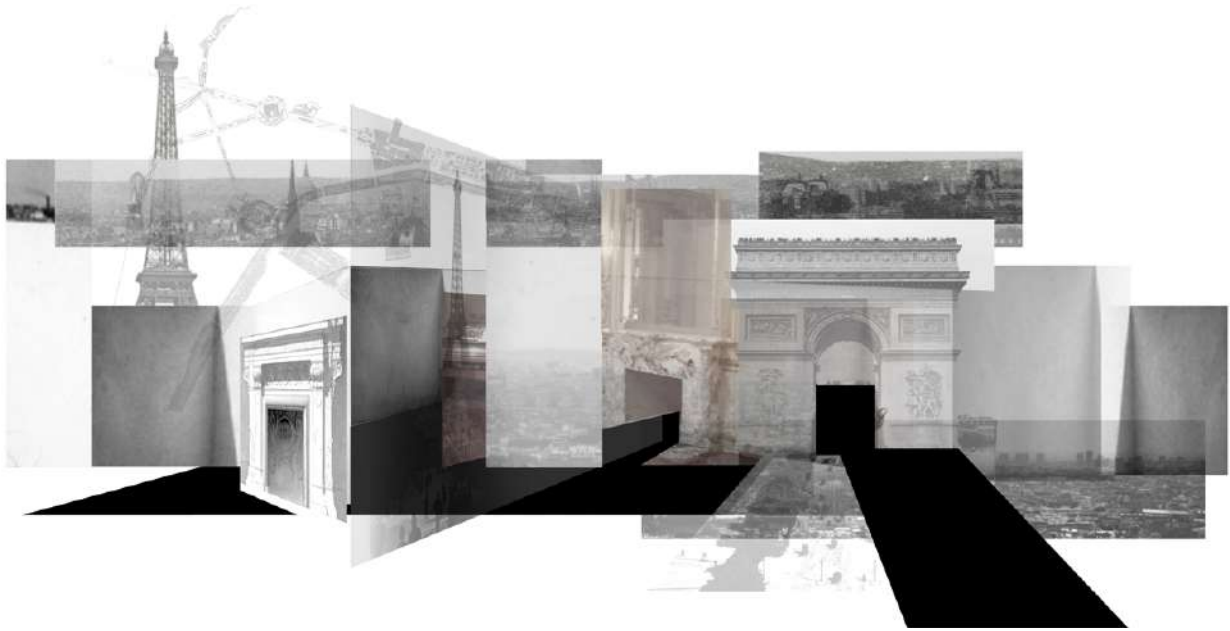

FIG. 3 Collage: Surrealist Curation of Paris. Image by the author

through this horizon of urban images, he curates a surrealist imagination of the city from the domestic sphere through perceptions of individual city inhabitants. To achieve this surrealist curation of Paris in the rooftop terrace of Beistegui apartment, Le Corbusier designed a series of stairs and platforms that create an ascending terrace-like topography leading to the highest walled roof garden. The first landing of the terraces offers an isolated view of Notre Dame. An electrically powered fence, electrically powered windows, and mechanical installations theatrically work together to curate the observer's views of Paris. Beatriz Colomina describes this curated urban experience from the domestic sphere as "suppress[ing] this panoramic view of Paris [...] offering (instead), at precise places, moving views (*perspectives émouvante*) of four of the things [...] the Arc de Triomphe, the Eiffel Tower, Sacre-Coeur, Notre Dame."<sup>33</sup> The ascension of the series of terraces ends with a dramatic elevation alteration at the walled roof garden. It is the climax of a dream house that celebrates the transformation of domesticity into urban space. For Le Corbusier, this visual curation is to judiciously remove from sights the "Pack-Donkey" streets of the everyday city, conferring views only of four emblems of the "imperishable heritage" of Paris.<sup>34</sup> Gorlin also claims that the Beistegui apartment is a "model apartment" for the theory of Radiant City,<sup>35</sup> which curates the city through fragmented urban monuments through the perception of the city observers.

In Le Corbusier's surrealist architecture, the house invites the publicness of the city into its domestic sphere through analogies. The curated city

33 Beatriz Colomina, *Privacy and Publicity: Modern Architecture as Mass Media* (Cambridge, MA: MIT Press, 1994), 303.

34 Anderson, "All of Paris, Darkly," 118-19.

35 Gorlin, "The Ghost in the Machine," 60.

expands its boundaries into the domestic realm through poetic urban images [Fig. 3]. Le Corbusier demonstrates the provocative tensions between the palpable materiality and the latent subconsciousness of the urban space through surrealist curation. The poetic analogy instills a sense of mythical historicity in secular domesticity. Benjamin states that Le Corbusier's work ostensibly stands at the "terminus of the mythological figuration house," and then cites Sigfried Giedion's writing in *Bauen in Frankreich* to explain that the work of Le Corbusier brings an end to "a fatal and hereditary monumentality."<sup>36</sup> The practice of surrealist curation connects the house of "monumentalized domesticity" and the city of "domesticated monumentality"<sup>37</sup> through latent dreams.

## Domesticity and Urban Space

Benjamin describes urban streets as the "dwelling place" of the "collective," and he argues that the "collective," "eternally wakeful and agitated" as it is in the space between building façades, lives, experiences and understands the urban street "as much as individuals do within the privacy of their own four walls."<sup>38</sup> He further suggests that the "glossy enameled shop signs" are wall decorations, resembling "oil paintings in the drawing room," "the benches are bedroom furniture," and "the café terrace is the balcony", all of a bourgeois' house.<sup>39</sup> The above quote alludes to the metaphorical relationship between house and city. The collective dreams of Benjamin's *flâneurs* transform the urban space into a domestic "house." He states that Paris "opens up to the *flâneur* as a landscape" and simultaneously "closes around the *flâneur* as a room," entering the *flâneur's* consciousness as both "the sensory data" of the beholder's eyes and "the abstract experienced knowledge as something experienced and lived through."<sup>40</sup> This dialectical interpretation of the *flâneur's* urban experiences reveals the fluidity of domesticity in the public sphere through curated imagination. One can infer that the corporeal movement and the sensorial perception of the *flâneurs* evoke a surrealist curation that poetically assembles an oneiric house between public and private realities.

## The Oneiric

In 2002, a "pilgrimage" procession commissioned by artist Alijs in collaboration with the Public Art Fund and The Museum of Modern Art in New York City dubbed the Modern Procession, carried reproductions of three selected works of art from MOMA in Manhattan on 53rd Street to MoMA's

---

36 Benjamin, *The Arcades Project*, 407.

37 Vesely, "Surrealism and the Latent World of Creativity," 272.

38 Benjamin, *The Arcades Project*, 879.

39 Ibid.

40 Ibid, 880.

temporary location in Queens on 33rd Street. The procession traversed the boroughs of New York City from Manhattan to the city's peripheral Queens in a ritualized ceremonial movement. It demonstrates a curated urban experience and produces a surrealist urban situation through a choreographed journey. The procession transforms the urban space into a mnemonic landscape through montages of urban images and curates an ecstatic experience of analogical juxtapositions. And it conjures up a transcendent surreal encounter (*objet trouvé*) through these juxtapositions. As the carried art objects move through urban streets of New York City, they transform the urban space into a collection of metaphors: urban façades become public stages. Distinct urban elements through which the urban space is curated as a "phantom-like"<sup>41</sup> image makes up this surreal encounter. The displacement of institutionalized objects in the public domain makes the human body both an agent and extension of the objects that facilitate a poetic narrative of analogy. The participants of the procession experience the city through fragmented moments framed by the art objects and urban space. The movement of the procession recounts changing landscapes juxtaposed through time and space that consequently create "luminous sparks" that act as "guideposts of the minds," transforming into the "supreme reality."<sup>42</sup> The replicas—of Marcel Duchamp's Bicycle Wheel, Pablo Picasso's *Les Femmes d'Alger*, and Alberto Giacometti's Standing Woman #2—coincides with the surrealist. For artist Aliş, the considerable "endurance factor" needed for the participation of the long procession certainly contributes to stimulating and reinforcing "an emotional tension" from which "the strain and exertion can produce a kind of massive phenomenon of collective hallucination."<sup>43</sup> This "collective hallucination" resonates with the shocks and intoxication of modern experiences which Benjamin attributes to the urban phenomena of the nineteenth-century Paris. He compares the intoxication to "narcotic thinking" and argues that the surrealist *flâneur* practices this narcotic "profane illumination of thinking" like the opium eater, the dreamer, and the ecstatic.<sup>44</sup> Thus, one can argue that the "collective hallucination" embodies surrealist ecstasy that produces hallucinated collective urban imagination. The participants domesticate the city with dreams and the city houses the participants' imagination in the public sphere.

However, the movement of the procession encompasses subjectivity and individuality. Harper Montgomery proposes that Aliş injects the carried art objects with "subjectivity" and "agency" by weaving a story around their journey and their encounters with random elements in the urban street.<sup>45</sup> This subjectivity is revealed through relationships amongst the objects, the

---

41 Veselý, "Surrealism and the Latent World of Creativity," 268.

42 Breton, *Manifestoes of Surrealism*, 43.

43 Francis Aliş, *The Modern Procession* (New York: Public Art Fund, 2004), 92-93.

44 Benjamin, *Walter Benjamin*, 216.

45 *Ibid*, 135.



participants, and the urban space. Museum curator Lynne Cooke argues that the choreographed activities and roles assumed by such participants as “the band, the palanquin bearers, and those assigned to distribute flowers and rose petals en route,” are essential to the procession, but they also offer rooms for deviations and “subjective desires” to the participants.<sup>46</sup> The “subjective desires” implies a sense of privacy within collective public movements. For artist Kiki Smith, the performance of the art “living icon” imparts her with personal rumination that curates unique urban images from the perspective of the moving palanquin she sits, the carriers that surround her, and the rhythmic movements she endures. The participants of the procession who scatter rose petals and blow soap bubbles en route cultivate their narratives with kinesthetic urban situations. The replicated artworks curate relationships with their carriers through the movement. The Peruvian brass band and the dog walkers in the procession relate their urban experiences to sounds, images, and scents. Alÿs believes that the procession “transforms” or “crystallizes” the energy that is already in the urban space by occupying the public streets.<sup>47</sup> In this case, the poetic analogies of the juxtaposed urban realities through surrealist curation restore the energy of the place and transform it into a public stage for social dramas.

## The Shell

The shell encloses a house that provides a domestic and private place for dwellers. Benjamin associates the idea of “dwell[ing]” in relation to “indwelt spaces” with “an indication of the frenetic topicality concealed in habitual behavior” which “has to do with fashioning a shell for ourselves.”<sup>48</sup> The “indwelt spaces” are the urban streets of New York City and the dwellers are the participants of the procession. The procession and the urban façade are two different shells, with the procession being the soft, moving shell, and the urban façade the static, hard shell. Colomina writes “in a city where the reality was not the place itself but its displacement, in a place that was not a place because everything was fluid, to stop was to mask oneself, to cease to be real, [...] like ‘posing for a photograph,’ by sitting in a ‘modern’ square.”<sup>49</sup> For Colomina, immobility and indecipherability equate to wearing a mask. The movement of the procession unveils the façade (mask) of the practice and reveals its interiority. The façade of the moving procession juxtaposes itself with the changing urban façades, closing upon itself with a shell against an outside reality. The shell thus demarcates a curated interiority in the public sphere. The other mask (urban façade) indicates exteriority as Colomina states that “interior” disorders

---

46 Ibid, 121-22.

47 Ibid, 94.

48 Benjamin, *The Arcades Project*, 222.

49 Colomina, *Privacy and Publicity*, 26.

of the modern city are veiled under the mask.<sup>50</sup> The art objects of the procession are like furniture, which also approximates how members of the bourgeoisie might dream of decorating or furnishing their urban apartments, particularly since these are reproductions (not originals). And the “furniture” further claims the interiority in the public exterior space. The procession thus inverts the exterior urban streets into domestic interiors. Benjamin writes: “it is as though the bourgeois were so sure of his prosperity that he is careless of façade, and can exclaim: my house, no matter where you choose to cut into it, is façade [...] The street becomes room and the room becomes a street. The passerby who stops to look at the house stands, as it were, in the alcove.”<sup>51</sup> The shell of the procession invites the public and opens itself up to the urban space like windows, and the shell of the urban façade curates the outside views for the participants of the procession. The surrealist curation delineates two façades of two urban realities that curate experiences for both the participants and the spectators, transcending the urban streets through time and space [Fig. 4].



FIG. 4 Collage: Surrealist Curation of The Modern Procession. Image by the author

50 Ibid, 23.

51 Benjamin, *The Arcades Projec*, 406.

## Museum and Domestication

Benjamin argues that museums belong to the “dream houses” of the “collective,” and represent the inside as “an interior magnified on a giant scale.”<sup>52</sup> The interiority of a museum retains dreams and fantasy of the collective, curating itself into a domestic place that houses the imagination of it. Benjamin asserts that the collecting of paintings in a museum is an act of displaying paintings of pictures to “glorify” the interior of the museum and he states that the museum transforms into an interior place through the medium of the paintings.<sup>53</sup> By extension, museums represent cultural domestication, and their interiors evoke private dreams. Veselý also claims that by virtue of the formation of modern museums, the complex reality of a city is reduced to the scale of a house which illustrates a process that culminates in a general “domestication” of culture.<sup>54</sup> In the Modern Procession, the dispatch of consecrated modern art objects to urban streets “examines the edge between the private experience of making art and the public reading of its meaning.”<sup>55</sup> The act of bringing art objects to the urban streets of New York City from MoMA during the procession further blurs the edges between the private and public domains. It transports interiority and domesticity of an institutional museum into the public urban domain by removing the protective envelope of the museum and exposing it to the exterior.

The curatorial intentions of the Modern Procession are decidedly surrealist. Alj's claims that “the clash of human body with a metropolis” calls for a “constant and immediate reaction and interaction with the urban entity,” which indicates that “the freedom in the art field” makes the Modern Procession respond to the city promptly, thus curating the urban space in an ephemeral way that is impossible in the “heavy architecture machine.”<sup>56</sup> Art historian Roselee Goldberg believes that the Modern Procession functions as a “choreographic experimentation” that serves to reexamine “a fragment of urban geography.”<sup>57</sup> The city is curated through analogical narratives of juxtaposed urban realities played by bodies, objects, and façades. The poetic urban images bring a surrealist “dream house” to the public sphere and transform both the participants and the spectators’ perceptions of urban boundaries.

---

52 Ibid, 406-7.

53 Ibid, 408.

54 Veselý, “Surrealism and the Latent World of Creativity,” 269.

55 Alj's, *The Modern Procession*, 106.

56 Ibid, 101.

57 Ibid, 106.

## Conclusion

In the case of Le Corbusier's Beistegui apartment, the surrealist curation crafts an urban experience through a poetic architectural language that engages the public with domestic architectural space through the tactic of analogy, cultivating a latent fabric of Paris. Le Corbusier meticulously composes intentional analogical collages, uses poetic images of architectural fragments to demonstrate an interplay between the interior and exterior. The urban elements respond to the domestic architectural language and stage a theatrical narrative of urban transformations in the gaze of the inhabitants of both the house and the city. The curated domesticity within urban space obscures the typical boundary between the house and the city, acting as a mediator between the finite interior and the infinite exterior. In the case of Alijs's Modern Procession, the juxtaposition between the moving and the static erects an ephemeral reality in the city that forms an event in a sequence of analogies, the kinesthetic human bodies and institutionalized art objects revise the urban situation simultaneously in a poetic horizon with a surreal encounter in vision, memory, and imagination. The surrealist curation sets up a dream house on urban streets, directing an ephemeral transformation between the public and the private spheres. The potency of the procession is established through "walking," which in turn occupies, engages, and transforms urban space through time and space and begets a continuous narrative that can be translated into a linguistic poetic reading. The poetic image from this case derives from both the collective consciousness and the individual imagination. The individual imagination folds into the choreographic urban experience and introspectively delineates a dream world between the past and the present; the collective consciousness enacts the city through metaphorical and mythical connotations and reinterprets the city from a historical horizon.

The poetic image embodied by the language of analogy restores a communicative potential for urban architecture. Pérez-Gómez writes that "we allow the means of expression in a building to envelop us in that haze of signification that derived from its particular arrangement and it may speak through a mute radiance."<sup>58</sup> The "radiant" illumination of the intentional analogy emits architectural meaning in poetic images and evokes human experiences through a surrealist curation that alludes to a different sphere of architectural understanding. It supersedes the discourse of function and program, of form and specifications, and traces architecture to the innate language of poetics. For Pérez-Gómez, this poetic language speaks universal truth and is central for the design in pluralistic societies.<sup>59</sup> He further defines "the duality of plastic human habits within a symbolic (linguistic) horizon" in architecture that "constitutes

---

58 Pérez-Gómez, *Attunement*, 175.

59 *Ibid*, 181.

the referential function of metaphor in poetry.”<sup>60</sup> The surrealist curation invests the plastic of human habits through a curatorial experience and encompasses the linguistic nature in its poetic craft of situations. Hence, it provokes a metaphorical reading of the world that surrounds us and yields new approaches to dissecting the palimpsest of culturally charged urban landscapes.

The poetic analogy exists in Benjamin’s practice of collecting, as he defines it “that the object is detached from all its original functions in order to enter into the closest conceivable relation to things of the same kind.”<sup>61</sup> The figure of the collector assembles metaphors in the world of dreams and memories. Benjamin asserts that the “dream house” arcades are “properties in the hand of a collector” that “strike” the collector in the “deepest stratum of the dream.”<sup>62</sup> The agency of surrealist curation acts as a collector who assembles urban images and interrupts the confines between the physical built world and the transcendental imagined layers of the world. Such reinvention of practice and urban tactics ground the world in the poetic nature and invest it with a surrealist fantasy, reinventing the meanings of our experiences. It challenges the mundane and the profane that has been for too long, fueled by analytical and parametrical understandings of our contemporary urban realms.

---

60 Ibid, 193.

61 Benjamin, *The Arcades Project*, 204.

62 Ibid, 204-5.

**Ke Sun,** is a Ph.D. Candidate in Architectural History and Theory studies at University of Florida, School of Architecture. He has both lectured and served as the Graduate Teaching Assistant for Architectural Theory courses at University of Florida. Sun's doctoral research deploys a phenomenological investigation of contemporary cities through the methodical perspective of flânerie theorized from nineteenth-century Paris. It conceives the flâneur as a spatial figure in relation to modernity and urbanity and perceives the public domain of urban space as a dream realm that brings an inquiry into the relationship between body, place, and city-making.

## References

- Aljys, Francis. *The Modern Procession*. New York: Public Art Fund, 2004.
- Anderson, Ross. "All of Paris, Darkly: Le Corbusier's Beistegui Apartment, 1929-1931." Valencia, Spain, 2015. <https://doi.org/10.4995/LC2015.2015.928>.
- Benjamin, Walter. *Reflections: Essays, Aphorisms, Autobiographical Writings*. Edited by Peter Demetz. Translated by Edmund Jephcott. New York: Schocken Books, 1978.
- . *The Arcades Project*. Translated by Howard Eiland and Kevin McLaughlin. Cambridge, MA: Harvard University Press, 1999.
- . *Walter Benjamin: Selected Writings, Volume 2: 1927-1934*. Edited by Michael W. Jennings, Howard Eiland, and Gary Smith. Cambridge, MA: Harvard University Press, 1999.
- Breton, André. *Manifestes du surréalisme*. Paris, France: Jean-Jacques Pauvert, 1962.
- . *Manifestoes of Surrealism*. Ann Arbor: University of Michigan Press, 1969.
- Buck-Morss, Susan. *The Dialectics of Seeing: Walter Benjamin and the Arcades Project*. Cambridge, MA: MIT Press, 1991.
- Chaplin, Sarah, and Alexandra Stara, eds. *Curating Architecture and the City*. New York and London: Routledge, 2009. <https://doi.org/10.4324/9780203876381>
- Colomina, Beatriz. *Privacy and Publicity: Modern Architecture as Mass Media*. Cambridge, MA: MIT Press, 1994.
- Corbusier, Le. *Towards a New Architecture*. Reprint edition. New York: Dover Publications, 1985.
- Foucault, Michel. *The Order of Things: An Archaeology of the Human Sciences*. New York and London: Routledge, 2002.
- Gorlin, Alexander. "The Ghost in the Machine: Surrealism in the Work of Le Corbusier." *Perspecta* 18 (1982): 51–65. <https://doi.org/10.2307/1567035>.
- Harrison, Robert Pogue. *The Dominion of the Dead*. 1st edition. Chicago: University Of Chicago Press, 2003.
- Pérez-Gómez, Alberto. *Attunement: Architectural Meaning After the Crisis of Modern Science*. Cambridge, MA: MIT Press, 2016. <https://doi.org/10.7551/mitpress/10703.001.0001>
- Švácha, Rostislav. "Surrealism and Czech Functionalism." Translated by Jan Valeška. *Umeni / Art* 55, no. 4 (August 2007): 316–28. <https://doi.org/10.2478/v10008-007-0009-x>
- Vesely, Dalibor. "Surrealism and the Latent World of Creativity." *Umeni / Art* 59, no. 3/4 (June 2011): 267–73. <http://lp.hscl.ufl.edu/login?url=http://search.ebscohost.com/login.aspx?direct=true&AuthType=ip,uid&db=asu&AN=65463658&site=eds-live>.
- Vidler, Anthony. *The Architectural Uncanny: Essays in the Modern Unhomely*. Cambridge, MA: MIT Press, 1992.





## MAIN SECTION

# Hegemonic Struggles in the City: Artist-Run Spaces and Community Art in the Anti-Gentrification Movement

Leila Haghighat – Universität für Angewandte Kunst Wien (Austria) – Contact: lahaghighat@gmail.com

## ABSTRACT

Gentrification processes are one of today's most critical social issues hitting metropolises around the globe. The role that artists play in these processes by upgrading neighborhoods and making them attractive for further commodification is undisputed. At the same time, independent artist-run project spaces in neighborhoods provide spaces for debate and initiate collective processes. Not only small independent actors and collectives interfere in the political debates, but also large public art institutions that respond to current social and political issues and public demands.

Artistic interventions in urban transformation processes are also political interventions, expressing the permeability of the line between art and politics. Indeed, thinking along the political philosopher Antonio Gramsci, such a line does not exist; rather, every cultural and artistic project must be thought of politically. Drawing on theoretical approaches on hegemony, this article aims at examining the critical aspects of community art in relation to the current gentrification processes.

## KEYWORDS

*Artist-run spaces; Lefebvre; Gramsci; Community art; Gentrification*

## PEER REVIEWED

<https://doi.org/10.6092/issn.2612-0496/10321>

ISSN 2612-0496

Copyright © 2020 Leila Haghighat



FIG. 1 Installation of Kotti & Co / Kotti-Coop / Kotti-Shop / SuperFuture: [Der Kotti ist kein Ponyhof] <https://www.hebbel-am-ufer.de/programm/pdetail/kotti-shop-der-kotti-ist-kein-ponyhof/> at Berlin bleibt! Festival 2019, photo Monique Ulrich

Gentrification is one of the most critical social issues faced by metropolises around the globe today. The role that artists play in gentrification by making neighborhoods attractive for further commodification is well documented.<sup>1</sup> At the same time, independent artist-run project venues provide spaces for discussion and initiate collective action against capitalist, gentrifying forces. Small, independent organizations and collectives are not the only actors from the art world taking part in these political debates. Large public art institutions are also engaging with current social and political issues and responding public demands. When art intervenes in urban transformation processes it functions as a political intervention and shows the permeability of the line between art and politics. According to the political philosopher Antonio Gramsci, such a line does not exist; rather, all cultural and artistic projects must be thought of politically. This article argues that socially engaged art practices face the unavoidable risk of reproducing social conditions, even if they are conducted with best intentions. This risk is increased due to the fact that artistic practice is often considered to be merely benign, even when self-described as politically engaged. Art criticism rarely engages deeply with political theory. Counteracting this tendency, the present work proposes that artists involved in community-based initiatives be analyzed as embodying the figure of the organic intellectual as described by Gramsci [Fig. 1].

1 See for example Stuart Cameron and Jon Coaffee, "Art, Gentrification and Regeneration—From Artist as Pioneer to Public Arts," *European Journal of Housing Policy* 5 no. 1 (2005): 39–58; Rosalyn Deutsche and Cara Gendel Ryan, "The Fine Art of Gentrification," *The Portable Lower East Side* 4 no. 1 (1987).

## The city as a hegemonic battlefield

Artistic interventions in cities are usually based on emancipatory claims. In principle, these initiatives focus on encouraging local residents' participation and the co-design of urban and social processes. The French Marxist philosopher Henri Lefebvre has pointed out that space is a social product and, thus, it reflects social conditions.<sup>2</sup> Significantly, his work influenced a subfield of Marxist-informed geography that seeks to analyze what role spatiality plays within social structures and processes—i.e. how the structures of power in a particular society are replicated and thereby reinforced in that society's spatial organization.<sup>3</sup> Lefebvre is known for his demand for citizens to claim the "right to the city,"<sup>4</sup> a claim that has acquired a new significance in light of gentrification.<sup>5</sup> The social divisions produced by class and prosperity, property rights and the power of disposal, as Stuart Hall remarks,<sup>6</sup> are exacerbated in many cities by gentrification. Gentrification is omnipresent in 21st century urban life. For centuries, metropolises like New York, Berlin, and Istanbul have attracted very diverse population groups. Cities absorb wealthy global nomads as well as tourists, migrants, and artists. One consequence of migration to urban centers is the substantial exclusion and displacement of those who cannot keep up with the ever-increasing competition for housing. In this context, the city, where the social order becomes spatially materialized, can be regarded as a political battlefield. Lefebvre emphasizes the active role of space in reproducing hegemony, "as knowledge and action, in the existing mode of production."<sup>7</sup> In his "Gramscian reading" of Lefebvre, Stefan Kipfer speaks of an "urban hegemony," identifying the city as one locus of political-economic contestation and making everyday urban life the terrain in which hegemony is negotiated.<sup>8</sup> In accordance with Kipfer's idea, urban voices that are critical of the current social order from the cultural and artistic fields interfere with and try to influence civil society. From a hegemonic theoretical understanding, neither culture nor the arts are neutral or harmless. Rather, they are always already existing within structures of domination and power.

---

2 Henri Lefebvre, *The Production of Space* (Oxford & Cambridge: Blackwell, 1991).

3 Georg Glasze, "Eine politische Konzeption von Räumen," in *Diskurs und Hegemonie*, ed. by Iris Dzudzek, Caren Kunze, and Joscha Wullweber (Bielefeld: transcript, 2012): 155.

4 Henri Lefebvre, *Le droit à la ville* (Paris: Economica, 2009).

5 I refer to Andrej Holms definition of gentrification: "gentrification is any urban district-related revaluation process in which real estate economic strategies of valorization and/or political strategies of revaluation require the exchange of the population for their success. Displacement is the essence and not an unintended side effect of gentrification" Andrej Holm, *Wir bleiben alle! Gentrifizierung—städtische Konflikte um Aufwertung und Verdrängung* (Münster: Unrast, 2010), 102.

6 Stuart Hall, "Cosmopolitan Promises, Multicultural Realities," in *Divided Cities: The Oxford Amnesty Lectures*, ed. by Richard Scholar (New York: Oxford University Press, 2006), 24.

7 Lefebvre, *The Production of Space*, 11.

8 By Stefan Kipfer, "Urbanization, Everyday Life and the Survival of Capitalism: Lefebvre, Gramsci and the Problematic of Hegemony," *Capitalism Nature Socialism* 13, no. 2 (2002): 117-149.

## Hegemony and the politics of the cultural

According to Gramsci, hegemony is to be understood “as a social condition in which all aspects of social reality are dominated by or supportive of a single class” or group.<sup>9</sup> Hegemony describes how dominant groups use their influence to create a cultural hierarchy that maintains and justifies a social order in which they have disproportionate power and capital. Through hegemonic processes narratives about the political organization of society are normalized into “common sense.” Hegemony is not simply a passive form of dominance; rather, it must be constantly restored, renewed, defended and modified.<sup>10</sup> The negotiation of hegemony takes place not only in the realms of politics and the economy, but also in the realm of civil society. Culture, education and art play a critical role in the domain of civil society, shaping “common sense.” This negotiation hierarchically assigns value to different types of actions, lifestyles, and identities, privileging some and marginalizing others.<sup>11</sup> The hierarchically tiered values assigned to these things create a “view of the self and the world that encompasses not only consciousness, but everyday practices, routine actions and also unconscious dispositions,” according to Benjamin Opratko.<sup>12</sup> The negotiation of hegemony, and the fight for a hegemonic order that values oppressed (proletariat) lives and voices, involves a critical examination of and striving for a “higher elaboration of one’s own view of the real,”<sup>13</sup> which for Gramsci is an explicitly political project. He asserts that the “choice and criticism of a world view” is a “political fact.”<sup>14</sup> In this context, Gramsci also identifies the “politics of culture”<sup>15</sup> or the “politics of the cultural”<sup>16</sup> as an essential front in battle over hegemony. For him culture includes habits and perceptions of the world, as well as aesthetics and artistic practices.<sup>17</sup> Culture is as little separable from systematic power relations as politics is from the production of knowledge and identities, as Henri Giroux points out.<sup>18</sup> Thus, critical cultural work is central to Gramsci’s emancipatory thinking. In order to achieve liberation,

---

9 Peter Mayo, “Synthesizing Gramsci and Freire: Possibilities for a Theory of Radical Adult Education,” *International Journal of Lifelong Education* 13 no. 2 (1994): 127, in reference to David W. Livingstone, “On Hegemony in Corporate Capitalist States: Material Structures, Ideological Forms, Class Consciousness and Hegemonic Acts,” *Sociological Inquiry*, 46 (1976): 235.

10 Raymond Williams, *Marxism and Literature* (Oxford University Press, 1977), 112.

11 Iris Dzudzek, Caren Kunze, and Joscha Wullweber, “Einleitung: poststrukturalistische Hegemonietheorien als Gesellschaftskritik,” in *Diskurs und Hegemonie*, ed. by Iris Dzudzek, Caren Kunze, and Joscha Wullweber (Bielefeld: transcript, 2012), 18f.

12 Benjamin Opratko, *Hegemonie. Politische Theorie nach Antonio Gramsci* (Münster: Westfälisches Dampfboot, 2014), 44.

13 Antonio Gramsci, *Gefängnishefte: kritische Gesamtausgabe in 10 Bänden*, ed. by Klaus Bochmann, Wolfgang Fritz Haug, and Peter Jehle (Hamburg: Argument Verlag, 2012), 1384.

14 *ibid.*, 1378.

15 *ibid.*, 2113.

16 *ibid.*, 1689.

17 *ibid.*, 2108.

18 Henry A. Giroux, “Rethinking Cultural Politics and Radical Pedagogy in the Work of Antonio Gramsci,” *Educational Theory* 49, no. 1 (1999): 1–19.

the proletariat is supposed to break away from the given ideological contents of the bourgeoisie and (collectively) develop its own culture.<sup>19</sup> This elaboration of a distinct culture is a process of self-determination and, therefore, a form of intellectual and political self-empowerment. Engagement with the arts can be used to elaborate one's own culture and, thereby, to develop one's own "view of reality." However, this intellectual self-empowerment can only take place gradually.<sup>20</sup> Gramsci calls the slow cultural, ideological and political penetration of the proletariat worldview into civil society and state institutions a "War of Position." He uses the term because, for him, "the superstructures of civil society [...] are like the trench system in modern warfare."<sup>21</sup> Culture especially, in which "various ideological layers" are united, is "the product of a complex elaboration."<sup>22</sup> According to political theorist Chantal Mouffe, the politics of the cultural must be conducted as a War of Position, where the central statements and practices that support and reproduce bourgeois hegemony should be dissected or disarticulated.<sup>23</sup>

Gramsci advocated engaging with art and culture dialectically. Changing art and culture goes hand in hand with changing society. Stuart Hall refers to the ensemble of language, signs, and images as systems of representation.<sup>24</sup> These systems contribute critically to the (re)production of social conditions, while a new society leads to new art and new culture. Accordingly, Mouffe sees the main task of artistic practices to be the production of new subjectivities and the elaboration of new worlds. That that is why it is necessary to initiate artistic interventions in a multitude of social spaces outside traditional institutions.<sup>25</sup>

The most important strategic actors in social struggles over hegemony are organic intellectuals. In Gramsci's understanding, all people are intellectuals, but not everyone can take on this function, since not everyone has the necessary qualifications.<sup>26</sup> Organic intellectuals are those who form a social, cultural group, they develop this group's self-understanding and organize its cohesion.<sup>27</sup> Social change is closely linked to how new ways of thinking, feeling, and acting are being developed and spread through a community. It is the organic intellectuals who organize the

---

19 Sabine Kebir, "Einleitung," in *Antonio Gramsci. Marxismus und Kultur. Ideologie, Alltag, Literatur*, ed. by Sabine Kebir (Hamburg: Argument Verlag, 1991), 12.

20 Gramsci, *Gefängnishefte*, 2178.

21 *ibid.*, 1589.

22 *ibid.*, 2178f.

23 Chantal Mouffe, "Alfredo Jaar: der Künstler als organischer Intellektueller," in *Alfredo Jaar. The Way It Is. Eine Ästhetik des Widerstandes* (Berlin: Neue Gesellschaft für Bildende Kunst, 2012), 270.

24 Stuart Hall, Jessica Evans, and Sean Nixon (eds.) *Representation* (London: Sage Publications, 2013).

25 Chantal Mouffe, *Agonistics. Thinking the World Politically* (London: Verso, 2013), 87.

26 Gramsci, *Gefängnishefte*, 1500.

27 Uwe Hirschfeld, *Notizen zu Alltagsverstand, politischer Bildung und Utopie* (Hamburg: Argument Verlag, 2015), 103.

development of “common sense” within their group and its dissemination. They organize the political consciousness of their group, as well as the group’s representation. After all, any group that seeks to become hegemonic is concerned with the goal of assimilation and the ideological conquest of traditional intellectuals; the more a group of organic intellectuals has developed, the more successful they will be at such an undertaking.<sup>28</sup> Since culture and art play a crucial role for the negotiation of hegemony, it would be reasonable to assume that artists can become organic intellectuals. Chantal Mouffe, for example, attributes this quality to all those who work in the field of art and culture. However, in Gramsci’s understanding, organic intellectuals cannot simply be defined by categories or activities. For him, questions of art are to be discussed separately from those of intellectuals and, thus, artists can take on the function of intellectuals, but do not necessarily do so.<sup>29</sup> Whether they act as organic intellectuals or not depends on the mindset of the artists and the context in which the artistic interventions are taking place.

## Emancipatory claims in artistic practices

Referring back to Gramsci’s emancipatory project of finding new ways of thinking, feeling, and acting and, thus, developing a new culture and new art; this project is reflected in many artistic initiatives with “communities”<sup>30</sup> that take place in so-called community and independent artist-run project spaces and that encourage the participation of neighborhood residents. As art historian Grant Kester remarks, concepts such as “empowerment” and “participatory democracy” that found political expression during the 1960’s were re-emerging in the rhetoric of community-based art in the 1990s.<sup>31</sup> The emergence of these participatory and socially engaged art forms can be traced back to earlier movements of the avant-garde. These include, for example, Dada, Constructivism, Surrealism, and also Futurism, which Gramsci first praised but later critiqued. These movements raised questions of originality and authorship, challenged conventional assumptions about the passive role of the viewer or spectator, and took an anti-bourgeois position on the role and function of art itself.<sup>32</sup> Subsequently, the neo-avant-gardes of the post-war period, such as Fluxus or the emergence of happenings, developed an increasingly participatory approach to artistic practice by involving the audience and

---

28 Gramsci, *Gefängnishefte*, 1500ff.

29 Cf. Ingo Lauggas, *Hegemonie, Kunst und Literatur. Ästhetik und Politik bei Gramsci und Williams* (Wien: Erhard Löcker GesmbH, 2013), 38.

30 I use the term “community” to refer to community art. However, a precise definition of community would open up another discussion, which cannot be conducted here. I therefore put “community” into quotation marks.

31 Grant H. Kester, “Aesthetic Evangelists: Conversion and Empowerment in Contemporary Community Art,” *Afterimage* 22, no. 5 (January 1995): 5–11.

32 Irish Museum of Modern Art (IMMA), “WHAT IS Education and Community Programmes” (2010), 28. <[www.imma.ie](http://www.imma.ie)>.

orienting themselves towards “reality.”<sup>33</sup> As the author Stella Rollig argues in her brief historical outline of activism and participation in the arts in the 20th century, the emancipation movements of the 1960s, especially in the USA, had a significant impact on the arts.<sup>34</sup> In 1969, for example, the “Art Workers Coalition” was founded to promote the representation of women and People of Color in the art world and to fight “against the neglect of the socially disadvantaged in cultural provision.”<sup>35</sup> Other initiatives arose to work with underprivileged group, in order to encourage them to formulate their own ideas and find their own cultural expression.<sup>36</sup>

The demands for enlightenment, politicization, and effectiveness beyond an art audience, which arose at the beginning of the 20th century, were further elaborated in the art practices of the 1990s, whose central idea became critical social intervention.<sup>37</sup> This happened in dialogue with the emergent scholarly field of Cultural Studies which was characterized by its “desire for ‘real’ life, for mixing with popular culture, for insight, participation and change.”<sup>38</sup> Strongly influenced by Gramsci, scholars of Cultural Studies examined the triangle of culture, power, and identity in hegemonic struggles “for dominance and subordination, inclusion and exclusion of social groups.”<sup>39</sup> In particular, research in Cultural Studies focuses on the significance of popular culture—which includes *folklore* in Gramsci’s words—within the struggle for cultural hegemony.

In the 1990s new terms emerged within art criticism to describe the ways that artists engaged with political topics. These concepts are useful for understanding socially committed art practices like those examined below. The term “context” refers to the specific spatial and socio-historical site of an artistic intervention. It also refers to the structures and conditions in and under which artistic production and presentation take place. Taking context as such into account naturally also brings about institutional critique. The terms “process,” “project,” and “practice” foreground the importance of the act of production over the final artistic product.<sup>40</sup> The concept of “public sphere” refers to the exhibition of the production as

---

33 Christian Kravagna, “Arbeit an der Gemeinschaft. Modelle partizipatorischer Praxis,” in *Die Kunst des Öffentlichen. Projekte, Ideen, Stadtplanungsprozesse im politischen, sozialen, öffentlichen Raum*, ed. by Marius Babias and Achim Könneke (Amsterdam/Dresden: Verlag der Kunst, 1998), 31.

34 Stella Rollig, “Zwischen Agitation und Animation. Aktivismus und Partizipation in der Kunst des 20. Jahrhunderts,” in *Dürfen die das? Kunst als sozialer Raum*, ed. by Stella Rollig and Eva Sturm (Wien: Turia + Kant, 2002), 4.

35 *ibid.*

36 *ibid.*, 5

37 Stella Rollig, “Das wahre Leben. Projektorientierte Kunst in den neunziger Jahren,” in *Die Kunst des Öffentlichen. Projekte, Ideen, Stadtplanungsprozesse im politischen, sozialen, öffentlichen Raum*, ed. by Marius Babias and Achim Könneke (Amsterdam/Dresden: Verlag der Kunst, 1998), 14f.

38 *ibid.*, 16

39 Oliver Marchart, *Cultural Studies* (Konstanz: UKV Verlagsgesellschaft, 2008), 35.

40 Rollig, “Das wahre Leben. Projektorientierte Kunst in den neunziger Jahren,” 16f.

well as the reception of it beyond the art field.<sup>41</sup> The focus on “community” usually implies working with (supposedly) ethnic, social, or political minorities, as well as the cultural representation of these groups, which can have a politicizing and community-building impact.<sup>42</sup> The keyword “self-organization” refers to an infrastructure for production, presentation, publication, and distribution created by artists themselves, and independent, artist-run project spaces.<sup>43</sup> The terms “communication,” “information,” and “reflection” signify a “desire for common ground, participation, exchange” that is pursued via debates and discussions.<sup>44</sup> The concept of the “cultural worker” is a redefinition of the figure of the artist. According to this concept, the artist’s role is no longer limited to artistic production. Instead, the cultural worker operates in spaces that are not exclusively deemed artistic, addresses different public spheres, works collectively rather than individually, and, above all, conducts interdisciplinary research and intervention beyond the artistic field.<sup>45</sup> The concept of “cultural worker” can already be thought as approaching the figure of the organic intellectual. Lastly, “counter-publicity” refers to the creation of a political public sphere through the use and transgression of the actual art context<sup>46</sup> in cooperation between artists and political groups.<sup>47</sup>

The author and curator Nato Thompson refers to “socially engaged art” as less an art movement than a reference to the possibility of a “new social order—ways of life that emphasize participation, challenge power, and span disciplines ranging from urban planning and community work to theater and the visual arts.”<sup>48</sup> Arts figures act as effective instruments for discussing socio-political issues by using their professional attributes such as “performativity, representation, aesthetics and the creation of affect” in order to have an impact on the political sphere.<sup>49</sup> Both in terms of content and method, socially committed and participatory art forms claim to have emancipatory powers to affect social conditions. Opinions vary greatly about in what ways and to what extent these art forms should intervene in society. According to art historian Christian Kravagna, the demands for change “vary according to the ideological basis”<sup>50</sup> of artists, project leaders, institutions. These can be revolutionary demands (as in Peter Bürger’s concept of the *Aufhebung der Kunst in Lebenspraxis*),

---

41 *ibid.*, 17f.

42 *ibid.*, 19f.

43 *ibid.*, 21f.

44 *ibid.*, 22f.

45 *ibid.*, 23f.

46 BüroBert (ed.), *Copyshop Kunstpraxis & politische Öffentlichkeit. Ein Sampler von Büro Bert* (Berlin: Edition ID-Archiv, 1993).

47 Rollig, “Das wahre Leben. Projektorientierte Kunst in den neunziger Jahren,” 26

48 Nato Thompson (ed.), *Living As Form: Socially Engaged Art from 1991-2011* (Cambridge, Mass.: MIT Press, 2012), 19.

49 *ibid.*, 22.

50 Kravagna, “Arbeit an der Gemeinschaft,” 31.



or reformatory demands (“the democratization of art”), or appeals with lesser political content that call for more playful and/or didactic changes in perception and “consciousness.”<sup>51</sup> Participatory art does not always have to be about direct participation, but simply about the problematization of participation, as theorist Juliane Rebentisch reasonably remarks.<sup>52</sup>

The positive political implications of these participatory and socially engaged art forms can hardly be called into question.<sup>53</sup> However, how and by whom artistic projects and programs are designed will have a critical effect on their political possibilities. In other words, it is important how “organic” the involved artists are to the respective group or “community,” and out of which desire/motivation they act. To return to the initial question, it may be asked at this point how close artists come to the function of organic intellectuals. Following Gramsci, the attitude of organic intellectuals should be examined more closely from the point of view of their suitability for the subaltern struggle for hegemony. In order to analyze the socio-political function of intellectuals, it is necessary to explore and test their psychological attitude and to ask whether they have a “paternalistic” attitude toward the group or “do they think they are an organic expression of them?”<sup>54</sup>

To give an example of a community-oriented artistic intervention that was based on a paternalistic attitude, Kravagna uses the New Genre Public Art, which made a name for itself in the mid-1990s. He clearly identifies the problems associated with addressing a specific audience as a process of “othering” and the construction of an “Other” as a condition for further projections.<sup>55</sup> The “Others” are poor and disadvantaged, held up as representatives of what is real and genuine. On the one hand, they were seen as being in need of help and, on the other, as a source of inspiration.<sup>56</sup> Such “Others” were to be helped through art, as it was intended in one of the group’s first and most prominent community art projects, *Culture in Action*, where several artists worked with urban communities in Chicago between 1992 and 1993. They created formats such as community gardens, dinner parties, interactive sculptures, on topics like AIDS, gang violence, public housing, multicultural demography, and neighborhoods. The project was meant to “lead away from the object into the lives of real people, real neighborhoods.”<sup>57</sup> And these “real people” and “real communities,”

---

51 *ibid.*

52 Juliane Rebentisch, *Theorien der Gegenwartskunst* (Hamburg: Junius Verlag, 2013), 68.

53 Cf. Stefan Neuner, “Paradoxien der Partizipation. Zur Einführung,” *Das Magazin des Instituts für Theorie No 10/11* (2007): 4.

54 Antonio Gramsci, *Selections from Prison Notebooks*: Antonio Gramsci, ed. by Quentin Hoare and Geoffrey Nowell Smith (London: Lawrence & Wishart, 1971), 275; Gramsci, *Gefängnishefte*, 1975.

55 Kravagna, “Arbeit an der Gemeinschaft,” 31ff.

56 *ibid.*

57 Michael Brenson, “Healing in Time,” in *Culture in Action*, ed. by Mary Jane Jacob, Michael Brenson, and Eva M. Olson (Seattle: Bay Press, 1995), 20.

in turn, were to be empowered by the means of art to aspire to something greater and to have their “real voices” be heard.<sup>58</sup> Kravagna critiques the actions of artists who enter marginalized communities with the intention of educating them, likening the artists to evangelizing missionaries.<sup>59</sup> For Grant Kester the work with urban communities “is understood to produce certain pedagogical effects in the community.”<sup>60</sup> By drawing on Pierre Bourdieu’s analysis of the problematic relationship that exists between a particular community and the “delegate” who chooses or is chosen to speak on its behalf,<sup>61</sup> Kester comments that the supposed “community” (political and symbolic) is only created through the medium of expression of the delegate.<sup>62</sup> By romanticizing the Other in this way and interpellating the Other as a marginalized subject, the project instrumentalizes and reproduces the very social inequalities which it was meant to counteract.

### Artist-run-spaces

In contrast to projects where communities are created by a delegate, independent artist-run project spaces are at least partially rooted their “communities.”<sup>63</sup> The communities exist in the neighborhoods prior to the “creative” act of delegation, and project spaces engage in a long-term idea-exchanges due to their proximity to their target audiences. Some of the problems associated with short-term projects, especially with regards to having outsiders speak for/over the voices of the community, are mitigated when artist-run spaces undertake long-term collaboration with people from their neighborhoods. When long-term collaboration takes place, residents themselves feel a sense of ownership over the space’s activities and are given a voice in decision-making processes. Nevertheless, most of the time the artists still differ from residents in categories like class or ethnicity.

There is a long history of such spaces working within their local communities, mainly in Western art metropolises. The spaces are organized by the artists themselves. They provide a platform for other artists and are not funded by public money. They produce and exhibit art in experimental, discursive, and interdisciplinary ways.<sup>64</sup> These artist-run-spaces are usually found in old city centers, which have low rents, high levels of diversity, and close proximity to other facilities of artistic production. It is not surprising

---

58 *ibid.*, 26.

59 Kravagna, 36.

60 Kester, “Aesthetic Evangelists.”

61 Pierre Bourdieu, “La délégation et le fétichisme politique,” *Actes de la recherche en sciences sociales* 52–53 (1984): 49–55.

62 Kester, “Aesthetic Evangelists.”

63 Here it has to be stressed that the spatial structure of neighborhoods is not equal to the structure of communities.

64 Séverine Marguin, “Die Pluralisierung der Autonomie. Eine soziologische Untersuchung über die freien Berliner Projekträume,” in *Autonomie der Kunst? Zur Aktualität eines gesellschaftlichen Leitbildes*, ed. by Uta Karstein and Nina Tessa Zahner (Wiesbaden: Springer VS, 2017), 290.



FIG. 2 June 10, 2001, Picnic project by Erik Göngrich, Oda Projesi courtyard, Galata-Istanbul, photo: Oda Projesi archive.

that the artists running these spaces start to interact with neighborhood residents, and even actively involve them in creative work, as the artists themselves become integrated into the community. Living side by side has a reciprocal effect on artists and residents alike. Yet, having artists present in a neighborhood enhances an area both qualitatively and symbolically. As their presence draws capital into neighborhood, artists are accused of fostering gentrification. Of course market forces have dictated that these neighborhoods are the only areas where many of such artists can afford to rent a space. At the same time, the independent spaces themselves easily fall victim to gentrification and, thus, organize resistance to it out of a “solidarity of interest” with their neighbors. In Gramsci’s understanding, this solidarity is an important phase in political struggles.<sup>65</sup>

One example of this process is seen in the work of *Oda Projesi*, an artist collective that rented an apartment in the Galata district of Istanbul in 2000. The apartment was converted into a project space that facilitated encounters between local residents, guests, and artists. The interaction with the residents arose naturally as the artists and neighbors got to know each other better.<sup>66</sup> The artists tried to find a form of collaboration with their neighbors, and the space served as an open studio for diverse (not only artistic) activities and as a meeting place for neighbors. As one of the few low-budget project spaces in the city center addressing urban issues, *Oda Projesi* is considered to be an important artistic intervention in Istanbul.<sup>67</sup> Later, the collective’s projects fundamentally dealt with

65 Gramsci, *Gefängnishefte*, 1560.

66 OdaProjesi, “Ohne Dach, jedoch mit Hof,” in *The Art of Urban Intervention. Die Kunst des urbanen Handelns*, ed. by Judith Laister, Margarethe Makovec, and Anton Lederer (Wien: Löcker Verlag, 2014), 123.

67 Pelin Tan, “‘Quale Utopia?’ Failure of Urban Utopias and the Approach to the City,” in *The [Un] Common Place. Art, Public Space and Urban Aesthetics in Europe*, ed. by Bartolomeo Pietromarchi (Barcelona: Actar, 2005), 176.



FIG. 3 Exhibition of PASAJ "61 meters of Kahya Bey Street" at Apartment Project Berlin, October 2015, photo David Gauffin

the ongoing gentrification of the area, about which they wanted to raise public awareness and amplify local critical voices. After they lost their premises in 2005 due to gentrification, they held a number of activities in other spaces, including artist residencies. Projects used a variety of media to continue their exploration of urban space. These included the founding of a local radio station as well as the publication of books, postcards, and magazines. One such publication was the *Annex* newspaper,<sup>68</sup> which served as a platform where residents, artists, and scholars could communicate with each other [Fig. 2].

Another example from Istanbul of an independent artist initiative is *PASAJ*, which was founded in 2010 and moved to *Tarlabaşı* in 2012, a district close to Taksim square. Although *Tarlabaşı* has been an economically depressed part of the urban center for decades, it is currently the subject of a government-sponsored urban renewal project. The *PASAJ* space is used for workshops, artist-in-residence programs, and exhibitions. The artists behind *PASAJ* have used the project space to develop a participatory and interactive socially engaged art practice in collaboration with the residents of the neighborhood. In 2015, *PASAJ* took part in the year-long project *We decide how we reside*, initiated by *Haus der Kulturen der Welt* (HKW) (Berlin), which dealt with questions of fair housing. *PASAJ* organized workshops with children living in *Tarlabaşı* in order to educate young people about urban transformation. The workshops produced sixteen films in which the children interviewed other residents about the positive and negative aspects of life in the neighborhood, showing the diversity of the area's inhabitants and the ways that neighbors relate to one another. For *PASAJ*, the project also served as the first phase of a larger documentation effort about *Tarlabaşı*, a place whose character is severely endangered due to encroaching gentrification [Fig. 3].

68 <http://odaprojesi.blogspot.com/2009/10/annex-say-4-ckt-annex-issue-4-is-out.html>, accessed November 11, 2020.



FIG. 4 Exhibition at Kotti-Shop for "We decide how we reside," October 2015, © David Gauffin

Another independent art and project space with a similar profile that took part in the HKW project was Kotti-Shop in Berlin. Founded in 2009, the space tries to create a meeting space where residents of the Kreuzberg Zentrum (NKZ) can connect. NKZ is a large social housing building with eleven floors and about 300 apartments surrounding Kottbusser Tor, an area stigmatized as a "bad neighborhood" that is also a destination for "cool" global nomads. The NKZ is one of two buildings that has been at the heart of discussions about "ghettos" and "social hotspots" in Berlin since the late 1990s.<sup>69</sup> Several newspaper articles have even characterized the residents of NKZ as dangerous and criminal.<sup>70</sup> In spite of the stigma, rents are rising there and residents are afraid of the impact and consequences of gentrification. As a response, a number of initiatives have been founded that focus on the social fabric of the neighborhood. Kotti-Shop is one of such initiatives that has built a close link with residents [Fig. 4].

People whose voices are not usually heard in political and urban discourses should be listened to. The artists at Kotti-Shop focus on the neighborhood by analyzing, reflecting, examining and archiving the living environment, concrete stories, and personal experiences from the NKZ. This happens in collaboration with residents, ensuring that the artistic methods and expressions used are compatible with residents' needs and desires. Residents and artists craft and employ collages as

69 Ulrich Best, *Ghetto-Diskurse. Geographie der Stigmatisierung in Marseille und Berlin* (Universität Potsdam, 2001), 136.

70 *ibid.*

the basis for discussion and critical commentary on the issues facing the neighborhood. Additionally, other techniques, such as interviews, mapping, and 24-hour films are employed to produce residents' own narratives of the urban experience. The aim of these activities is to build up communication channels among the neighbors and to create structures for better co-existence and social cohesion. The artists' engagement with their community certainly had a politicizing effect. Together with the residents, the artists were involved in the resistance against the sale of the building to a private real estate company. The sale was averted and the building was taken over by a municipal housing association in 2017. The artists continue to act as delegates for residents in negotiations with the housing company. Recently, the residents negotiated with the housing company to have a room designated for social gatherings that is to be managed solely by residents. This is an example of actual political organizing against real estate speculation.

### Different elements of representation

In the examples discussed above, the artists may be regarded as organic intellectuals in a Gramscian sense. This is because the artists organize the political consciousness of members of the neighborhood by facilitating group meetings and fostering artistic engagement; they act as representatives of this so-formed group or "community" and, by extension, the whole neighborhood. The artists represent the community on two different levels. On the one hand, they represent residents through speech acts with outside actors, serving as the face of the neighborhood. On the other hand, the artists represent the community by post-producing the creative expressions of the residents.

To return to Lefebvre, these two types of representation serve as an active element in the production of space. The production of space is a process containing three equal and simultaneous dimensions: spatial practice or perceived space (*la pratique spatiale/l'espace perçu*), spatial representation or conceived space (*les représentations de l'espace/l'espace conçu*) and the representation spaces or lived space (*les espaces de représentation/l'espace vécu*).<sup>71</sup> The spatial practice (perceived space) is the concrete daily use of the space with its social interactions, daily present bodies, and the everyday life that inscribes itself in the space. Spatial representation (conceived space) is to be understood at the level of signification, the space as represented in maps, texts, or in the aforementioned artistic works like collages and videos. The third dimension, the representation spaces (lived space) describes the experience of space and its symbolic content, denoting something outside itself. Kottbusser Tor, for example, symbolizes not only the simultaneously repulsive/alluring

---

71 Henri Lefebvre, *La production de l'espace* (Paris: Anthropos, 2000), 48f.

multicultural Other, but also resistance against the neo-liberal sell-out of the city, as ongoing local struggle for affordable housing is concentrated there. Because art has the possibility changing what a place symbolizes in the social imagination, it has a significant impact on representation spaces (lived space). Representation, as Lefebvre puts it, enables a transition between presence and absence: through representation the Other becomes imaginable, apart from his presence.<sup>72</sup> Representation is therefore a link between presence and absence. Thus, artistic representation can have an impact on social and political reality—not only externally but also internally. For this reason, Cultural Studies scholarship is concerned with how meanings are generated by representations. According to Stuart Hall, representations do not simply neutrally depict reality, but are the result of interpretations and therefore meaning-constituting practices.<sup>73</sup>

Because the artists in the examples above are involved in, or even take over, different acts of representation in the negotiation of hegemony, they can be regarded as organic intellectuals. Nevertheless, it is crucial to question who can and should take on this role in which contexts, and, thus, who speaks for whom under what conditions. Because spaces both reflect and produce social reality, it is also important to ask who is represented in which spaces and how. Representation has both a political function and a symbolic function. In her canonical text *Can the Subaltern Speak*, Gayatri Chakravorty Spivak follows Karl Marx's account of the 18th Brumaire and describes representation as both *vertreten* (represent—in the sense of delegation of authority) and *darstellen* (re-present—in the sense of portrayal), defining the critical difference between “speaking for” and “talking about.”<sup>74</sup> According to Spivak, these two sides are to be differentiated but not to be separated as representation always contains both: there is no representation (*vertreten*) without re-presentation (*darstellen*). In the examples above, the artists represent their respective neighborhood on two levels, in speech acts and through post-production. The activities and results of the artistic workshops are represented to the outside world in two ways. In one sense, the artists represent their group in various speech acts and therefore “speak for” them as delegates (*vertreten*). In another sense, the artists post-produce the residents' creative work; they bring the aesthetic debates that have collectively arisen in the small processes into a form that is outwardly representative. This post-production is quite clearly a form of a re-presentation (*darstellen*). Spivak states that there is responsibility in representation. One is responsible for creating

---

72 Henri Lefebvre, *La présence et l'absence. Contribution à la théorie des représentations* (Paris/Tournai: Casterman, 1980).

73 Stuart Hall, “The Work of Representation,” in *Representation*, ed. by Stuart Hall, Jessica Evans, and Sean Nixon (London: Sage Publications, 2013), 1–47.

74 Gayatri Spivak, “Spivak—Can the Subaltern Speak?,” in *Marxism and the Interpretation of Culture*, ed. by Cary Nelson and Lawrence Grossberg (Urbana: University of Illinois Press, 1988), 277.

visibility and legitimation for those who cannot represent themselves, and for being aware of these two sides of representation.

## Struggle for neighborhoods on an (art) institutional level

In the War of Position in cultural hegemony, “neighbourhoods” are the critical strongholds. Neighborhoods can be regarded as communities in spatial-geographical contexts and places of social reproduction. Moreover, solidarity, which is for Gramsci essential for political will, is built through practice in spatial relations.<sup>75</sup> The social fabric of neighborhoods is often interpreted as an important backstage for social and political organization, and so great hopes are placed in the neighborhood precisely where it is necessary to compensate for the deficits of the political and economic system. This is especially true in the current moment of the global housing crisis. In Berlin in particular, a great number of initiatives and alliances have been formed within civil society to fight rising rents and displacement. The art and cultural scene has played a major role in this struggle. Both independent local actors and state-funded institutions have become involved in these efforts. Neighborhoods, artist-run spaces, and art institutions can be understood as combatants of the War of Position.

The *Theatre Hebbel am Ufer*, for example, opened its 2019 season with the Festival *Berlin bleibt!*, an interdisciplinary program devoted to local movements fighting against gentrification.<sup>76</sup> Like the aforementioned project *We decide how we reside*, the festival is emblematic of (progressive) art institutions that claim to create a democratic place for different voices and to intervene in political discourse. Nina Möntmann describes these activities as New Institutionalism.<sup>77</sup>

Institutions get involved in emancipatory projects and collaborate with local movements, collectives, and artists in order to connect art with people’s lives, a trend which has grown since the avant-garde and to commodify site specific knowledge. Art institutions portray themselves as national educational bodies that react to current crises, such as the housing crisis in metropolises. The involvement of art institutions in such projects can have positive outcomes for community members. Institutions have the ability to create innovative formats for social engagement and their

---

75 David Featherstone, “Gramsci in Action: Space, Politics, and the Making of Solidarities,” in *Gramsci. Space, Nature, Politics*, ed. by Michael Ekers and others (Hoboken: John Wiley & Sons, 2013), 68; for further reading see also María do Mar Castro Varela and Leila Haghghat, “Solidarity and the City: A Complicated Story,” in *Doing Tolerance: Urban Interventions and Forms of Participation*, ed. by Maria do Mar Castro Varela and Barış Ülker (Berlin & Toronto: Verlag Barbara Budrich, 2020), 67.

76 <https://www.hebbel-am-ufer.de/en/berlin-bleibt/>, accessed November 11, 2020.

77 Nina Möntmann, “The Enterprise of the Art Institution in Late Capitalism,” *Transversal Texts*, 2006 <https://transversal.at/transversal/0106/montmann/en>, accessed November 11, 2020.



platforms can amplify local voices through large outreach networks.<sup>78</sup> With their symbolic, representative, and infrastructural resources, art institutions have an “educational function” and are the essential venues for negotiating hegemony.<sup>79</sup>

Artists collaborate with state institutions for a variety of reasons: for financial support, for expanding the artists’ stage of representation, and to make use of institutional resources to further their cause.

Interestingly, the artists’ use of institutions complicates the notion of representation—who speaks where, and for whom—even further. These large institutions, and the artists that collaborate with them, are often accused of coopting critiques of capitalism and resistance to market forces merely for cultural or symbolic appeal, rather than out of any true concern for marginalized or disenfranchised people. Even with the best intentions, institutions and artists will always be the ones who profit the most from these kinds of projects, while the political effect for the one’s they are speaking for can never be guaranteed. There is, indeed, a danger of institutions using social causes primarily for their own gain. Similarly, artists should be aware of their own role as being the first wave of gentrifiers in poor neighborhoods. Although it is possible to criticize such projects, such critique should avoid either/or logic, and take into account the complex relationship involved.<sup>80</sup> Embracing this complexity, artist Theaster Gates turns abandoned buildings in Chicago into hubs for Black American culture. He does this in full awareness of the possible usufruct of his work by the market, describing one of his projects as “real estate art.” His interventions provide a meaningful suggestion for how to think about artists’ role in gentrification in a different way.<sup>81</sup> This practice and the underlying mindset correlate with what Lefebvre meant by a right to the city: a right to difference, conflict, and antagonism.<sup>82</sup> The employment of art in the negotiation of social conditions and political struggles has to be considered as what philosopher Jacques Derrida would describe as “pharmakon,” as poison and medicine at the same time.<sup>83</sup>

---

78 Irit Rogoff, “Turning,” *E-Flux Journal* #00 (2008) <https://www.e-flux.com/journal/00/68470/turning/>, accessed November 11, 2020.

79 Oliver Marchart, *Hegemonie im Kunstfeld. Die Documenta-Ausstellungen Dx, D11, D12 und die Politik der Biennalisierung* (Köln: Neuer Berliner Kunstverein // Verlag der Buchhandlung Walther König, 2008), 20.

80 For a deeper philosophical discussion of either/or logics and the double bind see: Leila Haghighat, “Schizophrenie und Ästhetik. Eine ideengeschichtliche Auseinandersetzung mit dem *double bind*,” in *Double Bind postkolonial. Kritische Perspektiven auf Kunst und kulturelle Bildung*, ed. by María do Mar Castro Varela and Leila Haghighat (Bielefeld: transcript, 2021).

81 Kathleen Reinhardt, “Theaster Gates’s Dorchester Projects in Chicago,” *Journal of Urban History* 41, no. 2 (2015): 195. <https://doi.org/10.1177/0096144214563507>.

82 Henri Lefebvre, “The Right to the City,” in *Writings on Cities*, ed. by Eleonore Kofman and Elizabeth Lebas (Malden: Blackwell, 1996), 63–181.

83 Jacques Derrida, *Dissemination* (Chicago: University of Chicago Press, 1981).

## No easy answers

Socially committed art practices that pursue an emancipatory claim have long established themselves in the temples of high culture. Gaining such prestigious institutional recognition can be useful for political struggles. But the question remains whether and how this recognition will be used to further emancipatory goals. While some artists confine their community-based work to the gallery or project space, others extend it into political action, as in the case of Kotti-Shop where the artists play a large role in the fight against gentrification. Even when artists' activities are more modest, the creative work they do can irritate the current hegemonic order and offer alternative visions for society.

The present work highlights the political aspects of community art by reflecting on how artists engage in urban struggles as organic intellectuals, especially when they carry out long-term, in-situ initiatives in local artist-run spaces. The concept of organic intellectuals can be helpful when examining how artists who work with communities threatened with gentrification are able to affect political or social change. Nevertheless, this paper does not attempt to provide a one-size-fits-all framework for understanding all projects of the sort described above. Neither does it resolve the question of how these techniques can be used to effectively bring about emancipatory results. Even artists working against capitalist forces as organic intellectuals are still bound within the system of capitalism. Capitalist forces and agitation against them are co-present and unresolvable, as no position exists totally outside of the social system. Thus, it is impossible to generalize about whether any particular artist engaged with communities and political struggles is or is not acting as an organic intellectual. As argued above, this clearly depends on the specific context and the conditions, as well as the mindsets and attitudes, of the artists. This article should serve as a guide for thinking these practices both politically and ethically, as a productive meditation on the contradictions that are critical in the War of Position over hegemony.

**Leila Haghighat** is a cultural worker based in Berlin, who studied cultural and political sciences at Université Paris VIII Vincennes/St. Denis. From 2013 to 2017, she was the coordinator for cultural education at the Haus der Kulturen der Welt, Berlin. Currently she is a PhD candidate at the University of Applied Arts in Vienna where her research focuses on socially engaged and participatory art in the context of gentrification. Specifically, she studies knowledge production in art and cultural education as well as the ways that art, space, politics, and society relate and interact with one another. Ms. Haghighat teaches on the topics of body, space, and representation and is a member of bildungsLab\*, a collective of feminist migrant academics who comment, intervene, and publish in the field of critical education.

## References

- Best, Ulrich. *Ghetto-Diskurse. Geographie der Stigmatisierung in Marseille und Berlin*. Universität Potsdam, 2001.
- Bourdieu, Pierre. "La délégation et le fétichisme politique." *Actes de la recherche en sciences sociales* 52–53 (1984): 49–55.
- Brenson, Michael. "Healing in Time." In *Culture in Action*, edited by Mary Jane Jacob, Michael Brenson, and Eva M. Olson. Seattle: Bay Press, 1995, 15–48.
- BüroBert (ed.). *Copyshop. Kunstpraxis & politische Öffentlichkeit. Ein Sampler von Büro Bert*. Berlin: Edition ID-Archiv, 1993.
- Cameron, Stuart, and Jon Coaffee. "Art, Gentrification and Regeneration—From Artist as Pioneer to Public Arts." *European Journal of Housing Policy* 5 no. 1 (2005): 39–58.
- Castro Varela, María do Mar, and Leila Haghighat. "Solidarity and the City: A Complicated Story." In *Doing Tolerance: Urban Interventions and Forms of Participation*, edited by Maria do Mar Castro Varela and Barış Ülker. Berlin & Toronto: Verlag Barbara Budrich, 2020, 53–71.
- Derrida, Jacques. *Dissemination*. Chicago: University of Chicago Press, 1981.
- Deutsche, Rosalyn, and Cara Gendel Ryan. "The Fine Art of Gentrification." *The Portable Lower East Side* 4 no. 1 (1987).
- Dzudzek, Iris, Caren Kunze, and Joscha Wullweber. "Einleitung: poststrukturalistische Hegemonietheorien als Gesellschaftskritik," in *Diskurs und Hegemonie*, edited by Iris Dzudzek, Caren Kunze, and Joscha Wullweber. Bielefeld: transcript, 2012, 7–28.
- Featherstone, David. "'Gramsci in Action: Space, Politics, and the Making of Solidarities.'" In *Gramsci. Space, Nature, Politics*, edited by Michael Ekers and others. Hoboken: John Wiley & Sons, 2013, 65–82.
- Giroux, Henry A. "Rethinking Cultural Politics and Radical Pedagogy in the Work of Antonio Gramsci," *Educational Theory* 49, no. 1 (1999): 1–19.
- Glasze, Georg. "Eine politische Konzeption von Räumen." In *Diskurs und Hegemonie*, edited by Iris Dzudzek, Caren Kunze, and Joscha Wullweber. Bielefeld: transcript, 2012, 151–71.
- Gramsci, Antonio. *Selections from Prison Notebooks: Antonio Gramsci*, edited by Quentin Hoare and Geoffrey Nowell Smith. London: Lawrence & Wishart, 1971.
- . *Gefängnishefte: kritische Gesamtausgabe in 10 Bänden*, edited by Klaus Bochmann, Wolfgang Fritz Haug, and Peter Jehle. Hamburg: Argument Verlag, 2012.
- Haghighat, Leila. "Schizophrenie und Ästhetik. Eine ideengeschichtliche Auseinandersetzung mit dem double bind." In *Double Bind postkolonial. Kritische Perspektiven auf Kunst und kulturelle Bildung*, edited by María do Mar Castro Varela and Leila Haghighat (Bielefeld: transcript, 2021).
- Hall, Stuart. "Cosmopolitan Promises, Multicultural Realities." In *Divided Cities: The Oxford Amnesty Lectures*, edited by Richard Scholar. New York: Oxford University Press, 2006, 20–51.
- . "The Work of Representation." In *Representation*, edited by Stuart Hall, Jessica Evans, and Sean Nixon. London: Sage Publications, 2013, 1–47.
- Hall, Stuart, Jessica Evans, and Sean Nixon (eds.) *Representation*. London: Sage Publications, 2013.

- Hirschfeld, Uwe, *Notizen zu Alltagsverstand, politischer Bildung und Utopie*. Hamburg: Argument Verlag, 2015.
- Holm, Andrej. *Wir Bleiben Alle! Gentrifizierung—Städtische Konflikte um Aufwertung und Verdrängung*. Münster: Unrast, 2010.
- Irish Museum of Modern Art (IMMA). "WHAT IS Education and Community Programmes" (2010).
- Kebir, Sabine. "Einleitung." In *Antonio Gramsci. Marxismus und Kultur. Ideologie, Alltag, Literatur*, edited by Sabine Kebir. Hamburg: Argument Verlag, 1991, 11–19.
- Kester, Grant H. "Aesthetic Evangelists: Conversion and Empowerment in Contemporary Community Art." *Afterimage* 22, no. 5 (January 1995): 5–11.
- Kipfer, Stefan. "Urbanization, Everyday Life and the Survival of Capitalism: Lefebvre, Gramsci and the Problematic of Hegemony." *Capitalism Nature Socialism* 13, no. 2 (2002): 117–149.
- Kravagna, Christian. "Arbeit an der Gemeinschaft. Modelle partizipatorischer Praxis." In *Die Kunst des Öffentlichen. Projekte, Ideen, Stadtplanungsprozesse im politischen, sozialen, öffentlichen Raum*, edited by Marius Babias and Achim Könneke. Amsterdam/Dresden: Verlag der Kunst, 1998, 28–47.
- Lauggas, Ingo. *Hegemonie, Kunst und Literatur. Ästhetik und Politik bei Gramsci und Williams*. Wien: Erhard Löcker GesmbH, 2013.
- Lefebvre, Henri. *La présence et l'absence. Contributions à la théorie des représentations*. Paris/Tournai: Casterman, 1980.
- , *The Production of Space*. Oxford & Cambridge: Blackwell, 1991.
- , "The Right to the City." In *Writings on Cities*, edited by Eleonore Kofman and Elizabeth Lebas. Malden: Blackwell, 1996, 63–181.
- , *La production de l'espace*. Paris: Anthropos, 2000.
- , *Le droit à la ville*. Paris: Economica, 2009.
- Livingstone, David W. "On Hegemony in Corporate Capitalist States: Material Structures, Ideological Forms, Class Consciousness and Hegemonic Acts." *Sociological Inquiry*, 46 (1976): 235–50.
- Marchart, Oliver. *Cultural Studies*. Konstanz: UKV Verlagsgesellschaft, 2008.
- , *Hegemonie im Kunstfeld. Die Documenta-Ausstellungen Dx, D11, D12 und die Politik der Biennialisierung*. Köln: Neuer Berliner Kunstverein // Verlag der Buchhandlung Walther König, 2008.
- Marguin, Séverine. "Die Pluralisierung der Autonomie. Eine soziologische Untersuchung über die freien Berliner Projekträume." In *Autonomie der Kunst? Zur Aktualität eines gesellschaftlichen Leitbildes*, edited by Uta Karstein and Nina Tessa Zahner. Wiesbaden: Springer VS, 2017, 283–304.
- Mayo, Peter. "Synthesizing Gramsci and Freire: Possibilities for a Theory of Radical Adult Education." *International Journal of Lifelong Education* 13 no. 2 (1994), 125–48.
- Möntmann, Nina. "The Enterprise of the Art Institution in Late Capitalism." *Transversal Texts*, 2006. <https://transversal.at/transversal/0106/montmann/en>, accessed November 11, 2020.
- Mouffe, Chantal. "Alfredo Jaar: der Künstler als organischer Intellektueller." In *Alfredo Jaar. The Way It Is. Eine Ästhetik des Widerstandes*. Berlin: Neue Gesellschaft für Bildende Kunst, 2012, 265–81.
- , *Agonistics. Thinking the World Politically*. London: Verso, 2013.

- Neuner, Stefan. "Paradoxien der Partizipation. Zur Einführung." *Das Magazin des Instituts für Theorie No 10/11* (2007): 4–6.
- OdaProjesi. "Ohne Dach, jedoch mit Hof." In *The Art of Urban Intervention. Die Kunst des urbanen Handelns*, edited by Judith Laister, Margarethe Makovec, and Anton Lederer. Vienna: Löcker Verlag, 2014, 112–27.
- Opratto, Benjamin. *Hegemonie. Politische Theorie nach Antonio Gramsci*. Münster: Westfälisches Dampfboot, 2014.
- Rebentisch, Juliane. *Theorien der Gegenwartskunst*. Hamburg: Junius Verlag, 2013, 68.
- Reinhardt, Kathleen. "Theaster Gates's Dorchester Projects in Chicago." *Journal of Urban History* 41, no. 2 (2015): 193–206.
- Rogoff, Irit. "Turning." *E-Flux Journal #00* (2008). <https://www.e-flux.com/journal/00/68470/turning/>, accessed November 11, 2020.
- Rollig, Stella. "Das wahre Leben. Projektorientierte Kunst in den Neunziger Jahren." In *Die Kunst des Öffentlichen. Projekte, Ideen, Stadtplanungsprozesse im politischen, sozialen, öffentlichen Raum*, edited by Marius Babias and Achim Könneke. Amsterdam/Dresden: Verlag der Kunst, 1998, 12–27.
- Rollig, Stella. "Zwischen Agitation und Animation. Aktivismus und Partizipation in der Kunst des 20. Jahrhunderts." In *Dürfen die das? Kunst als sozialer Raum*, edited by Stella Rollig and Eva Sturm. Vienna: Turia + Kant, 2002, 128–39.
- Spivak, Gayatri. "Spivak—Can the Subaltern Speak?" In *Marxism and the Interpretation of Culture*, edited by Cary Nelson and Lawrence Grossberg. Urbana: University of Illinois Press, 1988, 271–313.
- Tan, Pelin. "'Quale Utopia?' Failure of Urban Utopias and the Approach to the City." In *The [Un]Common Place. Art, Public Space and Urban Aesthetics in Europe*, edited by Bartolomeo Pietromarchi. Barcelona: Actar, 2005, 174–77.
- Thompson, Nato (ed.). *Living As Form: Socially Engaged Art from 1991-2011*. Cambridge, Mass.: MIT Press, 2012.
- Williams, Raymond. *Marxism and Literature*. Oxford: Oxford University Press, 1977.

## MAIN SECTION

# Curating for Care in Mexican Chicago: How a Museum Gave Voice to a Migrant Community

Guillermo Ruiz de Teresa – Royal College of Art (United Kingdom) – Contact: [ruiz.deteresa@network.rca.ac.uk](mailto:ruiz.deteresa@network.rca.ac.uk)

## ABSTRACT

This article looks at the practice of urban curating within diasporic communities through the lens of care. Urban curating provides a decolonial understanding of voice, responsibility and care within diasporic urban environments and across their expanded geographies. The Mexican neighbourhood of Pilsen in Chicago provides valuable learnings about how urban curating, enacted through the lens of care, has enabled a historically disenfranchised group to contest and confront prejudice, displacement, and injustice, by reinventing a classic institution of modernity, the museum. Through a close reading of the National Museum of Mexican Art and its curatorial program, this paper articulates the way in which the curatorial as a socio-cultural practice, has played a critical role in enabling migrants everyday engagement in the reconfiguration of the city. The curatorial practices of the Museum have provided forms of direct-aid to the community of Pilsen, cut across time and space for this multisited group and ultimately showed how art and culture can redefine the conditions under which urban transformation is contested and reframed, producing a new territory of and for Mexican Americans.

## KEYWORDS

*Urban Curating; Mexico; Chicago; Migrant; Art; Care; Curatorial*

## PEER REVIEWED

<https://doi.org/10.6092/issn.2612-0496/10172>

ISSN 2612-0496

Copyright © 2020 Guillermo Ruiz de Teresa



This paper explores urban curating as an emancipatory project for migrant communities within contested urban environments through a history of the Mexican community in Chicago, specifically the neighborhood of Pilsen.

Urban curating forges connections between economic, social, political, and aesthetic forces to transform a place from within its borders.<sup>1</sup> The practice of urban curating within the Mexican community in the city of Chicago, Illinois, contributes to this socio-spatial debate from a diasporic perspective.<sup>2</sup> It is a productive concept for the study of the transnational reconfiguration practices of sites of urban change through the lens of care, understood as a practice that valorizes the sharing of power, rather than its mere accumulation in the hands of the already powerful.<sup>3</sup> Urban curators can cut across time zones and multiple geographies, enabling the powerless to collectively contest the contradictions of neoliberal cities, marked by gentrification, austerity, inequality, and injustice.<sup>4</sup>

At the core of this study is Pilsen's National Museum of Mexican Art (NMMA) and its curatorial program. The research questions to what extent the curatorial, as a practice of care, has played a critical role in articulating the everyday engagement of a diasporic community in the transformation of the city, producing and protecting a new territory of and for Mexican Americans.

The paper engages the Museum, its leadership team and its curatorial archive in ethnographic methods such as participant observation, in-depth and elite interviewing, as well as textual and visual analysis of the curatorial material.<sup>5</sup> This study centers the analysis on three exhibition strategies through the lens of urban curating. The findings provide transferable learnings for migrant groups on how to engage with the city and its reconfiguration through transnational practices of care. This research, therefore, clarifies how diasporic communities can adopt the practice of urban curating to project and claim alternative possibilities through the built environment.<sup>6</sup>

---

1 Elke Krasny, "Neighbourhood Claims for the Future: Feminist Solidarity Urbanism in Vancouver's Downtown Eastside," in *The Social (Re)Production of Architecture*, ed. Doina Petrescu and Kim Trogal (New York: Routledge, 2017), 96-107.

2 I refer to diasporic perspective as a displaced and therefore transient perspective. For a discussion of the term from the perspective of urbanism see: Nishat Awan, *Diasporic Agencies: Mapping the City Otherwise* (Burlington, VT; Farnham: Ashgate, 2016).

3 Joan C. Tronto, *Moral Boundaries: A Political Argument for an Ethic of Care* (New York; London: Routledge, 2015)

4 Doina Petrescu and Kim Trogal, "Introduction: The Social (Re)Production of Architecture in 'Crisis-Riddled' Times," in *The Social (Re)Production of Architecture*, ed. Doina Petrescu and Kim Trogal (New York: Routledge, 2017), 1-13.

5 The fieldwork for this research paper took place between March and August of 2019. It is part of a research project on the Mexican American community in Pilsen and its hinterlands across Mexico.

6 Awan, *Diasporic Agencies: Mapping the City Otherwise*, 9.



The following sections will briefly explore the relationship between notions of care and curating as they relate to urban change. The study then refers to the central disciplinary debates emerging out of the conceptualization of urban curating as a practice in transforming the built environment and articulates how this practice is of particular relevance for diasporic communities. The research provides a background to Chicago and the urban struggles of the Mexican community in the neighborhood of Pilsen and its hinterlands. The final section looks at the NMMA and its curatorial program through the lens of urban curating.

The paper inquires how the Museum, through its exhibition strategy, has operated as an urban curator in providing direct care, expanding notions of territory and building resistance for Mexican Pilsen. Through the deployment of the arts and its performance within the public domain, urban curating has proved vital in unpacking “diasporic belongings and migrating knowledge”, claiming spatial justice for the Mexican community in the city of Chicago, Illinois.<sup>7</sup>

## From care to urban curating

Care is about what we do to “maintain, continue, and repair our ‘world’ so that we can live in it as well as possible.”<sup>8</sup> Curating, through its etymology, is directly associated with notions of care.<sup>9</sup> Derived from the Latin *curare*, the curator is originally a carer, a keeper of the museum collection and its relationships. The curator was understood to be in charge of its administration, organization, restoration, and comprehension, working in the back offices of the museum.<sup>10</sup> In the twentieth century, with the professionalization of the curator’s role that embraced an authoritative position, care took on a secondary role.<sup>11</sup> Moreover, as we approached the new millennium, the stature and influence of the curator increased significantly, signaling the rise of the curator as creator.<sup>12</sup> Within the conception of the curatorial,<sup>13</sup> the practice of curating engaged the production of knowledge

7 Elke Krasny and Meike Schalk, “Resilient Subjects: On Building Imaginary Communities,” in *Architecture and Resilience: Interdisciplinary Dialogues*, ed. Kim Trogal (New York: Routledge, 2018), 179-189 (p.183).

8 Joan C. Tronto and Berenice Fisher, “Toward a Feminist Theory of Caring,” in *Circles of Caring*, ed. E. Abel and M. Nelson (Albany, NY: SUNY Press, 1990), 36-54.

9 Charlotte Bates, Rob Imrie, and Kim Kullman eds., *Care and Design: Bodies, Buildings, Cities* (Chichester: John Wiley & Sons, 2016).

10 Pierre Bourdieu, *The Field of Cultural Production: Essays on Art and Literature*, ed. Randal Johnson (New York: Columbia University Press, 1993).

11 For a more extensive discussion on the evolution of curating during this period see: Terry Smith, *Talking Contemporary Curating* (New York: Independent Curators International, 2015), Hans-Ulrich Obrist and Lionel Bovier, *A Brief History of Curating* (Zürich: JRP / Ringier, 2008).

12 Bruce Altshuler, *The Avant-Garde in Exhibition: New Art in the 20th Century* (New York: Abrams, 1994).

13 The curatorial thinks beyond curating as the practice of a single author and focuses on everything that involves the event of knowledge in relation to one another. For a disciplinary context of this term and its implications, see: Maria Lind, “The Curatorial”, *Artforum International* (October 2009) accessed May 3, 2020, <https://www.artforum.com/print/200908/the-curatorial-23737>.

more broadly, beyond the exhibition space and its derivatives and towards what Irit Rogoff describes as an “expanding field” of broader contemporary knowledge bases and practices.<sup>14</sup>

Parallel to what Paul O’Neill has described as the “curatorial turn,”<sup>15</sup> the field of museum studies has also expanded its analytical framework to explore the museum as an epistemological tool for urban communities.<sup>16</sup> The need for inclusion and participatory policies gained traction within these institutional spaces. At the same time, museums gained recognition as spaces of intercultural exchange that question who has the power to create, to make visible, and to legitimate meanings and values.<sup>17</sup> Museums were increasingly understood as sites of hybridity, breeding new “areas of negotiation of meaning and representation” for communities operating at the margins.<sup>18</sup> Their capacity to enable negotiation and friction amongst hybridized societies<sup>19</sup> influenced the way museums can work curatorially.

Therefore, the curator’s role and responsibility grew in tandem with an expanded notion of the museum and its position within sites of urban change. The evolution of museums and curatorial discourse enabled a new reading of the performance of these institutions from the perspective of spatial practices.<sup>20</sup> In parallel, the understanding of the city as a social and cultural laboratory brought the curator closer to the work of urban planners and designers.<sup>21</sup>

---

14 For an overview on the concept of the curatorial, including Rogoff’s notion of the Expanding Field see: Jean-Paul Martinon, *The Curatorial: A Philosophy of Curating* (London: A&C Black, 2013).

15 Paul O’Neill, “The Curatorial Turn: From Practice to Discourse,” in *Issues in Curating Contemporary Art and Performance*, ed. Judith Rugg and Michèle Sedgwick (Bristol: Intellect Books, 2007), 13-28.

16 Eilean Hooper-Greenhill, *Museums and the Interpretation of Visual Culture* (New York: Routledge, 2000).

17 Simona Bodo, “Museums as Intercultural Spaces,” in *A Museum Studies Approach to Heritage*, ed. Sheila Watson, Amy Jayne Barnes and Katy Bunning (New York: Routledge, 2018), <https://doi.org/10.4324/9781315668505-40>.

18 Homi K. Bhabha, *The Location of Culture* (London: Routledge, 2012)

19 Simona Bodo, Kirsten Gibbs and Margherita Sani, *Museums as Places for Intercultural Dialogue* (Dublin: Dark Printing, 2009). For further context on this discussion from a diverse set of scholars across the globe see European project Museums as Places for Intercultural Dialogue (MAP for ID). See the research project MeLa\* - *European Museums in an Age of Migrations* for a broad overview of how European museums engage with their place as a strategic opportunity to develop ‘more inclusive forms of representation, localize social differences and tensions, and create progressive senses of belonging.’ “The MeLa\* Project” *MeLa Research Project*, accessed May 3, 2020, <http://www.mela-project.polimi.it/> (accessed May 4, 2020).

20 Doina Petrescu, *Altering Practices: Feminist Politics and Poetics of Space* (London: Routledge, 2007), <https://doi.org/10.4324/9780203003930>.

21 Urban curators, while often also museum professionals, construct curatorial programs through the deployment of anthropological methods, the production of knowledge of local situations, and close observations of community, places, and interaction across geographical boundaries. See: Nirmal Puwar and Sanjay Sharma, “Curating Sociology,” *The Sociological Review* 60, no. 1\_suppl (June 1, 2012): 40-63, <https://doi.org/10.1111/j.1467-954X.2012.02116.x>; Meike Schalk, “Urban Curating: A Critical Practice Towards Greater Connectedness,” in *Altering Practices: Feminist Politics and Poetics of Space*, ed. Doina Petrescu (New York: Routledge, 2007), 153-65.

## The curatorial as an urban practice of care

In the context of urban planning and design practices, curating means caring for people, places, and the way they relate to each other.<sup>22</sup> Practices of care emphasize processes that extend backwards and forwards in time, and concern all of the relationships that are created.<sup>23</sup> An urban curator is continually pushing back against conventional modes of planning and design practice by establishing new methods of cooperation among relationships of care.<sup>24</sup>

This concept is only a couple of decades old. Artist and community organizer Jeanne van Heeswijk, along with the architects CHORA and Raoul Bunschoten, were the first spatial practitioners to purposefully identify the curatorial as a framework for their exploration of “a situation, space, a neighborhood and the people connected to these.”<sup>25</sup> They see urban curators as practitioners overseeing the production of speculative scenarios, cooperative modes of negotiation, and liminal spaces to engender new possibilities.<sup>26</sup>

In dialogue with van Heeswijk and Bunschoten, urban scholar Meike Schalk has subsequently developed this concept by highlighting how critical the collection of information is to the planning process in the first place.<sup>27</sup> Through the establishment of an “urban curating” platform, Schalk and her colleagues have argued for new modes of cooperation between the planner, the designer, the client, and the user, across space and time.<sup>28</sup> Urban curating—and its infrastructure—has the potential to enable both proximate and distant connectedness to disentangle past relationships and future expectations, central to the understanding of care in relation to a migrant community.<sup>29</sup> It is a practice that can build relationships of care between local everyday practices in one place and those in other distant areas, their migrant hinterlands, as we will explore further in the case of Chicago.

---

22 Sophie Handler, “Ageing, Care and the Practice of Urban Curating,” in *Care and Design: Bodies, Buildings, Cities*, ed. Charlotte Bates, Rob Imrie, Kim Kullman (Chichester: John Wiley, 2019) 178-197 (p.190), <https://doi.org/10.1002/9781119053484.ch10>.

23 Angelika Fitz and Elke Krasny, *Critical Care: Architecture and Urbanism for a Broken Planet* (Cambridge, MA: MIT Press, 2019). Page numb.

24 Krasny, “Neighbourhood Claims for the Future.”

25 Mirjam Westen, “Jeanne van Heeswijk: The Artist as Versatile Infiltrator of Public Space - ‘Urban Curating’ in the 21st Century,” *n.paradoxa* 12 (2003): 24-32; Raoul Bunschoten, “Stirring Still: The City Soul and Its Metaspaces,” *Perspecta* 34 (2003): 56-65.

26 Raoul Bunschoten, “Urban Gallery, Urban Curation,” CORP Symposium, 2004; *Architecture and Participation*, ed. Peter Blundell Jones, Doina Petrescu and Jeremy Till (New York: Taylor & Francis, 2005), 56-57.

27 Schalk, “Urban Curating.”

28 For a more detailed look on how the term has evolved, see: Elke Krasny, “Urban Curators at Work: a Real-Imagined Historiography,” in *Planning Unplanned: Towards a New Function of Art in Society*, ed. Barbara Holub, Christine Hohenbuchler, (Vienna: Verlag für Moderne Kunst, 2015), p. 119.

29 Tim Gough, “Cura,” in *Curating Architecture and the City*, ed. Sarah Chaplin and Alexandra Stara (London: Routledge, April 16, 2009), <https://doi.org/10.4324/9780203876381-14>.

The practice of urban curating can also be read as a mode of direct aid.<sup>30</sup> Geographer Sophie Handler is one of the scholars critically exploring the political dimensions of care articulated by Fisher and Tronto in the use of art and performance-based interventions. Through her work with the elderly in London, Handler argues for embedding care in the curatorial process as a way to counteract stereotypical assumptions about different users and involve them on their terms, providing direct aid and support across their multiple geographies.<sup>31</sup>

Theorist Elke Krasny, through a “critical historiography” of urban curating, emphasizes the importance of care and reclaims the role of curating in “maintaining, continuing, and repairing our cities.”<sup>32</sup> The infrastructures that enable urban curating, through a constellation of caring relationships, are community centers, community museums, and even public art more generally. Underpinning these ordinary and conventional spaces of care are formal and informal networks of support from advocates, community organizers, artists, volunteers, and family members who seek to sustain the use of these spaces to avoid experiences of harassment and isolation in local neighborhoods and develop “resilient subjects.”<sup>33</sup>

This group of scholars, as well as the literature they draw from, sets the stage for an understanding of curating as a tool for those with an “outsider within” status in collectively transforming the city, positioning care at the center. From different fields, they argue for the potential of curating as a mode of engagement with the city that counteracts power imbalances. Their reading of the practice of urban curating is productive in the context of migrant communities, as it refers to a decolonial understanding of voice, responsibility, and care within contested urban environments and across their expanded geographies. Lastly, urban curating in this reconfigured context becomes an empowering mechanism that allows immigrants to lay claim to urban spaces and in turn open up a public platform of critical and reflective communication around their community. The Mexican community in Chicago provides valuable learnings about how urban curating, enacted through the lens of care, has enabled a historically disenfranchised group to contest and confront prejudice, displacement, and injustice, by reinventing a classic institution of modernity, the museum.

---

30 Other relevant conversations with this approach to urban curation is led by theorist Jane Rendell who introduces the urban practitioner as a mediator, as well as Barbara Holub, who looks at urban curation as involving practice and research resembling the activist urban researcher, suggested within critical urban geography. *Planning Unplanned: Towards a New Function of Art in Society*, ed. Barbara Holub, Christine Hohenbüchler (Vienna: Verlag für Moderne Kunst, 2015).

31 Handler, “Ageing, Care and the Practice of Urban Curating.”

32 Jenna C. Ashton, *Feminism and Museums: Intervention, Disruption and Change*. Volume 2 (Edinburgh: MuseumsEtc, 2018).

33 Krasny, Schalk, and Schalk, “Resilient Subjects.”

## Caring for Pilsen

The first Mexican neighborhood emerged in Chicago during the 1950s, after many of the Mexicans that had congregated around Hull House<sup>34</sup> since the turn of the century were displaced due to the expansion of the Dan Ryan Expressway.<sup>35</sup> The area around 18<sup>th</sup> Street was one of Chicago's oldest neighborhoods, that had been settled by Irish and German migrants in 1860. By the mid-twentieth century, it had become a Polish and Czech neighborhood, and named Pilsen after a Bohemian city.<sup>36</sup>

The making of Mexican Pilsen from the 1960s onwards, aided by the lowest rents in the city and its proximity to jobs, was also contemporaneous with the white flight to the suburbs and the massive loss of manufacturing jobs.<sup>37</sup> Nevertheless, even if the abandonment of the neighborhood by its initial settlers opened up space for incoming Mexicans, political power was still very much in the hands of the incumbent groups, in this case the Italians.<sup>38</sup> Not having access to traditional sources of political power, young Mexicans mobilized to develop infrastructures of care within their community as a way to fight for control of the neighborhood, which, in the vein of the Settlement House movement, centered around the arts.<sup>39</sup>

Mexicans in Chicago had an urge for visibility; they were quick to establish restaurants and businesses named after their home towns to affirm their identity.<sup>40</sup> Positioning "Mexicanness" as a stronghold of the neighborhood was a vital aspect of the "making" of Pilsen.<sup>41</sup> Painting murals across the district that depicted Mexican leaders, from Benito Juarez to Cesar Chavez, was the first instance of an urban approach to building territory for this community.<sup>42</sup> A necessary step after the successful "taking" of the streets and facades through murals was the appropriation of local

---

34 Founded in 1889 by reformer and Nobel Peace prize winner Jane Addams and Ellen Gates Starr. Inspired by Toynbee Hall in the East End of London, Hull House started a movement across the United States of Settlement Houses providing social work in disadvantaged communities. It quickly became a hub for the Mexican community, who started arriving in Chicago as early as 1919. For the history of the Hull House and the Settlement House movement, see: Jane Addams, *Twenty Years at Hull-House: With Autobiographical Notes* (Mineola, NY: Dover, 2012). For a detailed history of Mexicans at Hull House see: Sheryl Ganz and Margaret Strobel, *Pots of Promise: Mexicans and Pottery at Hull-House, 1920-40* (Chicago, IL: University of Illinois Press, 2004).

35 Juan Mora-Torres, "Pilsen: A Mexican Global City in the Midwest," *Diálogo*, 9, no.1, article 2 (2005).

36 A. K. Sandoval-Strausz, *Barrio America : How Latino Immigrants Saved the American City* (New York, NY: Basic Books; Hachette Book Group, 2019), 57-60.

37 Rita Arias Jirasek and Carlos Tortolero, *Mexican Chicago* (Mount Pleasant, SC: Arcadia Publishing, 2001).

38 Mora-Torres, "Pilsen: A Mexican Global City in the Midwest."

39 Influenced by the Chicano movement taking place at the time. Lilia Fernández, *Brown in the Windy City: Mexicans and Puerto Ricans in Postwar Chicago* (Chicago, IL: University of Chicago Press, 2012); Sandoval-Strausz, *Barrio America*.

40 Jose Gamaliel Gonzalez, *Bringing Aztlan to Mexican Chicago: My Life, My Work, My Art* (Chicago, IL: University of Illinois Press, 2010)

41 Lisa J. Akey, "Community Canvas: The Murals of Pilsen, a Chicago Neighborhood" (Ph.D.thesis, Indiana University, 2008).

42 For a history of the first murals, see: Gonzalez, *Bringing Aztlan to Mexican Chicago*.

institutions.<sup>43</sup> Mexican activists took over Howell House, run by the Presbyterian Church, a settlement house for the Czech community of Pilsen since 1886. In the wake of the Chicano movement, the Brown Berets occupied the building in 1970, renamed it as Casa Aztlan and covered its façade with murals depicting Latin American political icons.<sup>44</sup> Casa Aztlan, with its mission of “finding self-determination,”<sup>45</sup> was to become an important center of community activism, art production, and social services for the Mexican community in Pilsen, similar to the role that Hull House had provided earlier in the Near West Side.<sup>46</sup>

The social movements of 1969 and the appropriation of Casa Aztlan was followed by four key building trophies emerging out of subsequent fights which are still standing: the first bilingual public library, the only local high school, an early education center, and the museum.<sup>47</sup> The next section will unpack the particular role the museum played in expanding its role as an institution of care, through urban curating.<sup>48</sup>

## Urban curating as tool for power

It seems fitting that a community of immigrants trying to understand and assert its place within a hostile urban environment would use this institution as a way to develop new modes of informal citizenship practices and claim their rights to a territory.<sup>49</sup> Museums have been formative institutions of modernity, playing a significant role in establishing a civic dialogue and putting into practice ideas of citizenship.<sup>50</sup> The museum has provided a public space to perform the ritual of citizenship, binding the

---

43 Peter N. Pero, *Chicago's Pilsen Neighborhood* (Mount Pleasant, SC: Arcadia Publishing, 2011).

44 Antonio Zavala, *Memorias de Pilsen: Recuerdos de Lucha de un Barrio Mexicano en Estados Unidos* (s.l.: Tenoch Press, 2018).

45 Antonio Zavala, “Otras Ondas section [Casa Aztlán: Focus of Cultural Expression in the Midwest].” *Mirarte* (October 1, 1982), 4.

46 Ibid.; Crescencio Lopez-Gonzalez, *The Latinx Urban Condition: Trauma, Memory, and Desire in Latinx Urban Literature and Culture* (Lanham: MD: Rowman & Littlefield, 2019); Gonzalez, *Bringing Aztlan to Mexican Chicago*.

47 Rudy Lozano Public Library, the Benito Juarez High School, el Valor Health Clinic and the National Museum of Mexican Art were all established within a ten-year period. Lilia Fernández, *Brown in the Windy City*; Sandoval-Strausz, *Barrio America*.

48 Other institutions also were developed on the fringes of these larger publicly funded organisations such as the Taller del Grabado, the Prospectus Gallery, InkWorks and the Calles y Suenos Gallery, as well as the previous attempts to create a museum for the community under the MARCH and MIRA movements. For a history of these spaces see: Gonzalez, *Bringing Aztlan to Mexican Chicago*.

49 *Exhibiting Cultures: The Poetics and Politics of Museum Display*, 2nd edition, ed. Ivan Karp and Steven Lavine, Smithsonian Institution (Washington, DC: Smithsonian Books, 1991).

50 *Exhibiting Cultures; City Museums as Centres of Civic Dialogue? Proceedings of the Fourth Conference of the International Association of City Museums, Amsterdam, 3-5 November 2005*, ed. Renée Kistemaker (Amsterdam: Amsterdam Historical Museum, 2006).

community as a whole into a civic body.<sup>51</sup> In this case, the “contact zone”<sup>52</sup> of the museum went beyond its building and created a symbiotic relationship with a hostile urban context.<sup>53</sup>

The last decades of the twentieth century gave birth to a number of experiences of first-voice museums as tools to take charge of defining the role, breath, and understanding of a group of people and their own capacity to lead a conversation about how to go about transforming their neighborhoods on their terms.<sup>54</sup> First-voice museums became a productive response to the challenge of what DuBois called the African-American double consciousness, and later Gloria de Anzaldúa articulated as Mestiza consciousness, from the Latinx perspective. These spaces and their narratives provide tools to reconcile Mexican heritage with an American upbringing and therefore reidentify with a homeland they have been taught to reject.<sup>55</sup>

Differing from inclusive or participatory museum practices,<sup>56</sup> first-voice institutions provide a platform for diasporic communities to understand and care for themselves.<sup>57</sup> At the same time, first-voice institutions use their curatorial voice to subvert the notion of the seeing and display of oneself as an object that is common practice within the context of ethnographic or community museums.<sup>58</sup> In this case, it is about using the curatorial voice as a way to assert the Mexicans of Pilsen as experts, as their own sources of knowledge, to present them to themselves.<sup>59</sup> Nevertheless, it is essential to understand how the urban curating of Pilsen began, and its role in the evolution and maturity of this contested territory.

What we know today is that the National Museum of Mexican Art was founded in 1982 as the Mexican Fine Art Center by a group of six Chicago public school teachers in Pilsen, led by Helen Valdez and Carlos Tortolero, who later went on to direct the project.<sup>60</sup> The Center began as an itinerant exhibition project and public program, which partnered with local galleries

51 Tony Bennett, *The Birth of the Museum: History, Theory, Politics* (London and New York: Routledge, 1995); Carol Duncan, “Art Museums and the Ritual of Citizenship,” in *Exhibiting Cultures: The Poetics and Politics of Museum Display*, 88–103.

52 James Clifford, “Museums as Contact Zones,” in *Routes: Travel and Translation in the Late Twentieth Century*, ed. James Clifford (Cambridge, Mass.: Harvard University Press, 1997), 188–219.

53 Bodo, “Museums as Intercultural Spaces”; Elizabeth Crooke, *Museums and Community: Ideas, Issues and Challenges* (London: Routledge, 2008), <https://doi.org/10.4324/9780203371015>.

54 John R. Kinard, “The Neighbourhood Museum as a Catalyst for Social Change,” *Museum International* 37, no. 4 (1985): 217–23, <https://doi.org/10.1111/j.1468-0033.1985.tb00592.x>.

55 Gloria E. Anzaldúa, *Borderlands/La Frontera: The New Mestiza*, 4th ed. (San Francisco, CA: Aunt Lute Books, 2012).

56 Nina Simon, *The Participatory Museum* (Santa Cruz, CA: Museum 2.0, 2010).

57 Karen Mary Davalos, *Exhibiting Mestizaje: Mexican (American) Museums in the Diaspora* (Albuquerque, NM: University of New Mexico Press, 2001).

58 Ibid. 182.

59 Ibid. 183.

60 Nancy Villafranca-Guzmán and Carlos Tortolero, “The National Museum of Mexican Art: A New Model for Museums,” *The Journal of Museum Education* 35, no. 1 (2010): 83–92.

to start exploring notions of identity and belonging for Mexicans in Chicago through the power of the arts.<sup>61</sup>

The birth of the Mexican Fine Arts Center preceded the election of Mayor Harold Washington that was attributed in part to a broad coalition across the African American and Latinx communities in the city.<sup>62</sup> This new political context also transformed how minority populations were represented within the formal spaces of governance in the city. One example is the Parks Authority, home to Chicago's Museums in the Park.<sup>63</sup> Margaret Burroughs<sup>64</sup> appointment in the Parks District Board brought an impetus to the powerful institution to diversify its team and confront the pending allegations of discrimination and neglect amongst Black and Latinx neighborhoods.<sup>65</sup>

Omar Lopez, a Mexican community leader, was the first Mexican to join the team at the Parks Authority, at the point where they started looking into Harrison Park, at the core of Pilsen, in response to Washington's campaign promises to the Mexican community.<sup>66</sup> The main task at hand was to repurpose a boat repair facility that was no longer of use to wealthy Chicagoans.<sup>67</sup> In 1986, with support from the Park Commissions Board leadership, they signed a ten-year lease on what was a secondary structure at the south-eastern edge of the park, at least one-third of the size of the neighboring Field House.<sup>68</sup>

As a consequence of the volatile politics of the time, Adrian Lozano, a Hull House alumnus and an architect of Mexican descent, was chosen to design the project.<sup>69</sup> Lozano had a significant profile within Pilsen, mostly

---

61 Carlos Tortolero, in discussion with the author, June 2019. Villafranca-Guzmán and Tortolero; Davalos, *Exhibiting Mestizaje*, 109-110.

62 His triumph is largely attributed to the effective organising of key Mexican figures such as Rudy Lozano; this was the first time that Mexicans, and Latinxs more generally, were seen as critical for Chicago politics. For a more detailed discussion of how this took place see: Sandoval-Strausz, *Barrio America*, 201-215.

63 There are currently eleven museums in the Chicago Park District (the Art Institute of Chicago, the Chicago History Museum, the DuSable Museum of African American History, the Field Museum, the Museum of Contemporary Art, the Museum of Science and Industry, the Chicago Academy of Sciences, the John G. Shedd Aquarium, the National Museum of Puerto Rican Arts & Culture and the National Museum of Mexican Art). Established in 1903, Museums in the Park are institutions established in public land administered and partially funded by the Chicago Parks Authority. For a history of the establishment of this institutional arrangement see: Helen Lefkowitz Horowitz, *Culture and the City: Cultural Philanthropy in Chicago from the 1880s to 1917* (Ann Arbor, MI: University Microfilms International, 1985).

64 She was an important activist and leader among the African-American community and had been founder of the DuSable Museum a few years earlier, the first of the Museums in the Park within a minority neighborhood. Diane Grams, *Producing Local Color: Art Networks in Ethnic Chicago* (Chicago, IL: University of Chicago Press, 2010).

65 # Ibid., p.165.

66 Following his leadership in developing a community-wide sports league. Omar Lopez, in conversation with the author, June 2019.

67 The boat repair facility was being used only by 35 wealthy Chicagoans to house their boats, which proved offensive for the Mexican community now occupying most of that neighbourhood. Carlos Tortolero, 2019. Davalos, *Exhibiting Mestizaje*, 109.

68 Tortolero, 2019. Grams, *Producing Local Color*; Villafranca-Guzmán and Tortolero, "The National Museum of Mexican Art."

69 Tortolero, 2019. Davalos, *Exhibiting Mestizaje*, 109-110.



due to his history of engagement with the Hull House's arts program and the authorship of the first Mexican mural in the city.<sup>70</sup>

In a similar way to that in which Howell House became Casa Aztlan, the boathouse in Harrison Park became the Mexican Fine Arts Center-Museum (MFACM) through the appropriation of its facade.<sup>71</sup> The Parks Authority provided no additional funding for the refurbishment, so the structure remained almost intact, restricting the architectural intervention to a transformation of the building's skin,<sup>72</sup> and a somewhat more monumental entrance under the guise of a Mayan arc, amounting to an alleged \$900 investment.<sup>73</sup>

The MFACM developed a sense of responsibility, legitimacy, and belonging from both sides of the border, embodying Anzaldúa's Mestiza consciousness, through the notion of producing knowledge by being within a system while also retaining the knowledge of an outsider who comes from outside the system.<sup>74</sup> After the gallery opened its doors, it established a consistent curatorial program through the leadership of local artist Rene Arceo.<sup>75</sup> Arceo's first exhibition as curator was a solo show by Diana M. Solis, an artist born and raised in Pilsen and an essential member of Casa Aztlan and other politically active groups in the area.<sup>76</sup> Engaging so directly with the immediate neighbours was an important part of acting as simultaneously a multi-sited community center, art gallery, and assembly space for the growing community. The fact that this cultural institution was initially called both a center and a museum is critical for an understanding of their curatorial program from a perspective of care. Through its exhibitions and institutional partnerships, the MFACM

---

70 At the age of twenty, Lozano created *Progress of Mexico* in the second floor of the Boys' Club Building of Hull House. He depicted himself in the midst of pivotal moments in Mexican history. The mural was destroyed during the late 1960s with the expansion of the UIC campus, acquiring mythical status within the community. Cheryl Ganz and Margaret Strobel, *Pots of Promise: Mexicans and Pottery at Hull-House, 1920-40* (Chicago, IL: University of Illinois Press, 2004), 50-51.

71 The Benito Juarez High School, allegedly designed by Lozano as part of Bernheim, Kahn & Lozano after a proposal by Mexican architect Pedro Ramirez Vazquez, had also positioned mural work by local artists as its most salient design feature. Gonzalez, *Bringing Aztlan to Mexican Chicago*, 75.

72 Tortolero, 2019; Grams, *Producing Local Color*.

73 Its two subsequent expansions were also carried out by Lozano. In 2001: he added the Oaxacan motif from the archeological Zapotec site of Mitla around the entire building facade and tripled its footprint by including the adjacent natatorium structures initially built in 1914. Its current status is a result of its last refurbishment by Lozano in 2006, when it was rechristened as the National Museum of Mexican Art. Tortolero, 2019; Nancy Villafranca-Guzmán and Carlos Tortolero, "The National Museum of Mexican Art: A New Model for Museums." *The Journal of Museum Education* 35, no. 1 (2010): 83-92.

74 Anzaldúa, *Borderlands/La Frontera*.

75 A graphic artist originally from Michoacán, Arceo moved to Chicago and established himself in Pilsen in mid-1981. SAIC. National Museum of Mexican Art and Julian Samora Library at the Institute for Latino Studies (University of Notre Dame), *National Museum of Mexican Art Records*, 1983; René H Arceo-Frutos, *René Arceo: Between the Instinctive and the Rational*. (Chicago, IL: Casa Michoacán en el Medio Oeste, 2010).

76 National Museum of Mexican Art, *National Museum of Mexican Art, Exhibition Schedule*, 1983-2019.

consolidated its capacity to care for the transnational community while enabling a “contact zone” at a neighborhood level.<sup>77</sup>

### Three instances of urban curating for Mexican Chicago

The Center-Museum is a clear example of urban curating, situating care at the center of its curatorial understanding through three main strategies, visible across their curatorial archive: direct aid from within the community, caring across time and space and as a way to fight for a caring future.

#### Direct aid from within the community

The Center-Museum developed programming that made its building a space of care, a safe space for an at-risk community. The Museum broke new ground, bringing in critical public services as part of an exhibition program. One example of this is the exhibition *Latino Youth: Living with HIV/Aids in the Family*. The organizers worked with Pilsen-Little Village Community Mental Health Center and the Illinois Prevention Resource Center to exhibit stories and drawings by Chicago Latinx children who were living with HIV/AIDS.<sup>78</sup> The controversial public health crisis at the time, not openly discussed within the Mexican community,<sup>79</sup> was supported by an exhibition catalog, but most importantly with the hosting of a blood drive for the Hispanic AIDS Network within the Museum’s Courtyard Gallery.<sup>80</sup> The Museum also continued to expand its educational program outside its doors and across Pilsen, building a bilingual radio station at the heart of 18th Street in 1996.<sup>81</sup> A youth initiative called *Yolocalli* was established a few months later, and continues to cultivate its territorial influence with a yearly exhibition program within the Museum as well as an independent venue and a program of murals across 18<sup>th</sup> Street and its surroundings.<sup>82</sup>

---

77 Cesareo Moreno (NMMA curator), in conversation with author, Chicago, April 2019. Nancy Villafranca-Guzman (Former head of the education department at the NMMA), in conversation with author, Chicago, June, 2019.

78 Tortolero, 2019. Moreno, 2019. National Museum of Mexican Art, 1983-2019; National Museum of Mexican Art and Julian Samora Library at the Institute for Latino Studies (University of Notre Dame), *National Museum of Mexican Art Records*.

79 Lopez, 2019.

80 Exhibition Catalogue, “Latino Youth: Living With HIV/Aids in the Family | National Museum of Mexican Art,” <http://nationalmuseumofmexicanart.org/exhibits/latino-youth-living-hivaids-family>, (accessed May 3, 2020).

81 The radio station was sold in 2012. Villafranca-Guzmán and Tortolero, “The National Museum of Mexican Art.”

82 *Chicago’s Pilsen Neighborhood*; Davalos, *Exhibiting Mestizaje*. Tortolero, 2019. Moreno, 2019; Villafranca-Guzman, 2019.

## Expanding the notion of community across time and space

The Museum's subsequent exhibitions under Rene Arceo for its Main Gallery are evidence of its "borderless" approach across Pilsen and the communities of origin of its residents across Mexico. First, the Museum staff's strategy as urban curators went beyond the building, and included the neighborhood as a whole. A couple of months after opening the doors of the Center-Museum, Arceo launched *The Barrio Murals*, where he identified existing murals across Pilsen as centerpieces for the show. At the same time, he commissioned new work to be produced by these artists for the gallery space and published a catalogue that included all contributions.<sup>83</sup> For the first time, Mexican artists from Pilsen were being recognized as legitimate artists beyond their community centers and political groups.

Additionally, with the Museum acting as an art broker, a small market for their work started to develop amongst a group of burgeoning collectors from the community.<sup>84</sup> The value provided to their practice outside what previous centers were able to offer undoubtedly helped secure the role the Museum had within the Mexican artistic community around it.<sup>85</sup>

The second exhibition, a retrospective of the work of Alfredo Zalce, a highly respected artist from Arceo's native town of Michoacán, articulates a different territorial strategy. In this case, the project helped to establish a Mexican identity beyond Pilsen, most importantly across the communities in Mexico.

The "border thinking of multiple subjects contained within a single individual"<sup>86</sup> not being understood as "real Mexicans" by those back home, or as citizens of Chicago in their place of residence, is a sentiment expressed frequently by those growing up in Pilsen at the time.<sup>87</sup> The program of the Museum during those first years directly addresses this, looking at Mexico and the communities of origin of Pilsen residents as relevant exhibition platforms to engage with. Zalce's retrospective show was followed with a retrospective exhibition by Oaxacan artist Francisco Toledo, arguably the most prominent Mexican artist of the time. The MFACM offered the exhibition as a traveling show without cost to the Museum of Modern Art in

---

83 National Museum of Mexican Art, *Exhibition Schedule*.

84 National Museum of Mexican Art and Julian Samora Library at the Institute for Latino Studies (University of Notre Dame), *National Museum of Mexican Art Records*.

85 Many of these artists, such as Marco Raya, were members of the rival Casa Aztlan. National Museum of Mexican Art and Julian Samora Library at the Institute for Latino Studies (University of Notre Dame), *National Museum of Mexican Art Records*.

86 Ed Morales, *Latinx: The New Force in American Politics and Culture* (London; Brooklyn, N.Y.: Verso, 2018), 16

87 Leonard G Ramirez, *Chicanas of 18th Street: Narratives of a Movement from Latino Chicago*, (Chicago, IL: University of Illinois Press, 2011); Fernández, *Brown in the Windy City; Mexican Migration to the United States: Perspectives from Both Sides of the Border*, ed. Harriett D. Romo and Olivia Mogollon-Lopez, (Austin, TX: University of Texas Press, 2016).

Mexico City, as well as to smaller museums across the migrant communities most represented in Chicago, such as Zacatecas and Michoacán.<sup>88</sup> The archived correspondence across institutions shows an urge to create a show that would be recognized by established Mexican cultural institutions, as well as creating a presence amongst the communities of origin of many of Pilsen's residents.

The mixing of Pilsen-centric programming with exhibitions for communities across Mexico is an example of how urban curating, across all created relationships, defines new constantly evolving "borderlands" for a particular community in space and time.<sup>89</sup>

## Caring for Pilsen's future

As Tronto argues, all forms of care are embedded in relations of power. This last instance looks at how the MFACM leveraged their role as a cultural institution within Chicago more widely to build community resilience through their curatorial program. As their presence grew more robust and their platform more powerful, they partnered with local community organizations to exhibit work that documented and critiqued the urban development that had started to take place in the neighborhood after the 1990s.<sup>90</sup> In this instance, urban curating allowed for the neighbors in Pilsen to take control of the neighborhood through dialogue across planning, community activism, and the gallery space.

In 2006, after its last expansion, the Museum was officially accredited and renamed the National Museum of Mexican Art.<sup>91</sup> As the Museum has adopted a more national platform, the program has grown more robustly linked to other Latinx institutions across the United States, yet continues to strongly chronicle the artistic community of Pilsen.<sup>92</sup> Pilsen is now home to many organizations caring for those in Chicago and their Mexican native towns. This density of investment in Pilsen from the Mexican community

---

88 Most of Pilsen's residents from Mexican origin came from Zacatecas, Michoacán, Jalisco and Guanajuato. See Ganz and Strobel, *Pots of Promise*; Sandoval-Strausz, *Barrio America*; Zavala, *Memorias de Pilsen*.

89 Anzaldúa, *Borderlands/La Frontera*.

90 Exhibitions featured photographs of the area taken by its residents (*A Window to Our Neighborhood and Celebrate Pilsen: photographs by the children of Orozco Elementary School*, both in 1994; *El Punto Focal, Nuestra Comunidad Mexicana en Chicago*, 2007); murals were used to chronicle the history of the neighborhood (*Barrio Murals*, 1987; *Pilsen / Little Village: Our Home, Our Struggle*, 1997; *Outside In the Mexican American Street Art Movement in Chicago*, 2013; *40 años a la esperanza*, 2019) and the work of visual artists inside and outside gallery spaces (*Xicágo*, 2002; *Arte Diseño Xicágo*, 2017; *Placemaking & Landmarks - The Creation of Mexican Spaces in La Dieciocho (Pilsen)*, 2017; *Peeling off the Grey*, 2018) National Museum of Mexican Art, *Exhibition Schedule*.

91 The Museum gained accreditation from the Association of Museums of America in 2006 and broadened its collection to encompass more than 9,000 pieces. National Museum of Mexican Art and Julian Samora Library at the Institute for Latino Studies (University of Notre Dame), *National Museum of Mexican Art Records*.

92 National Museum of Mexican Art, *Exhibition Schedule*.

has been partly responsible for their displacement.<sup>93</sup> Gentrification in Pilsen is today at the heart of the fight for control of the neighborhood, with fewer Mexican-owned businesses and a smaller population, and a 22% increase in white population within approximately the last two decades.<sup>94</sup> One of the landmark events of this transformation was the closing and subsequent redevelopment of Casa Aztlan in 2017 into ten four-bedroom luxury apartments. Casa Aztlan's famous facade mural was painted over with a layer of grey paint.<sup>95</sup> The "greywashing" of this building sparked a significant backlash from community activists and artists who saw their work co-opted for increasing property value. The uproar around the city took on the slogan "Pilsen is not for sale." It surfaced the Museum's complicated position between being a source of power for the community and allegedly being leveraged by the gentrifying tide.<sup>96</sup>

In 2019, the Museum and its curatorial team, led by Cesáreo Moreno, decided to take a more vocal role and through an exhibition and public program entitled *Peel off the Grey*, alluding to the painting over of Casa Aztlan, sought to use art as a way to "pick, pry and peel off the layers of gentrification in Pilsen."<sup>97</sup> At stake, parallel to this exhibition, was the investment for a new office campus that used the mural typology to legitimize a renewal project. The project, decorated with new murals that resemble those found across Pilsen, is adjacent to the El Paseo public development project, where a community garden has been established as part of its first phase, and a proposed bike and pedestrian trail are planned to occupy a four-mile stretch of a rail line, while threatening to jumpstart a new wave of gentrification across the southern edge of the neighborhood.<sup>98</sup> The public project and its neighboring proposed development follows a different trajectory from the Museum and its creation, this time without what is now a much more robust community of organized Mexican artists and architects leading the design process.<sup>99</sup>

---

93 Davalos, *Exhibiting Mestizaje*, 165. Matthew L. Schuerman, *Newcomers: Gentrification and Its Discontents* (Chicago, IL: University of Chicago Press, 2019).

94 John Betancur and Yongjun Kim, (2016) "The trajectory and impact of ongoing gentrification in Pilsen." (Chicago, IL: Nathalie P. Voorhees Center for Neighborhood and Community Improvement, University of Illinois at Chicago, 2016)

95 Andrea Penman-Lomeli, "Developers Literally Whitewashed a Chicago Neighborhood's Historic Latino Murals", *CityLab*, <https://www.citylab.com/politics/2017/06/the-literal-whitewashing-of-chicagos-latino-murals/531156/> (accessed May 3, 2020),

96 Nunzia Borrelli and Kathleen Adams, "Analysing Pilsen Mexican Neighbourhood in Chicago through the Lens of Competitiveness and Social Cohesion," in *Moving Cities: Contested Views on Urban Life*, ed. Lúcia Ferro et al. (Wiesbaden: Springer, 2018), 133-51, [https://doi.org/10.1007/978-3-658-18462-9\\_9](https://doi.org/10.1007/978-3-658-18462-9_9); Jorge Inzulza-Contardo, "Latino Gentrification? Focusing on Physical and Socioeconomic Patterns of Change in Latin American Inner Cities," *Urban Studies* 49, no. 10 (2012): 2085-2107; John Betancur and Janet Smith, *Claiming Neighborhood: New Ways of Understanding Urban Change* (Chicago, IL: University of Illinois Press, 2016).

97 "Peeling off the Grey", *National Museum of Mexican Art*, <http://nationalmuseumofmexicanart.org/exhibits/peeling-grey> (accessed May 4, 2020),

98 "FAQ," El Paseo Trail [blog], January 19, 2019, <https://elpaseotrail.org/faq/>.

99 The architect of the winning project is a Chicago-based firm named Altamanu, an experienced design partnership with projects all across the city, but no discernible ties with the community. "About Altamanu Landscape Architecture", *Altamanu*, <http://www.altamanu.com/about> (accessed May 4, 2020),

The purpose of the exhibition was to expose the “dismantling of the heart of the community,” and included work from artists and activists protecting and defending Pilsen, yet with conflicting views on how to go about it. The exhibition space became a battleground in and of itself. One of the participants, who also happened to be one of the most ardent community activists, temporarily abandoned the exhibition before the opening, taking their work with them yet sparking a conversation that resonated across the city.<sup>100</sup>

The conversation around *Peeling off the Grey* culminated in a significant triumph for the community and its urban activism. The Landmarks Commission designated a 1.5 mile stretch of 18th Street as a Historic Landmark District.<sup>101</sup> This plan protects 800 late-nineteenth-century homes from being torn down and redeveloped, but also covers dozens of murals that have become icons of the neighborhood, thanks in large part to the scholarship and curatorial work of the National Museum of Mexican Art for the district. This conservation plan attempts to slow down gentrification and use historic preservation to preserve affordability, protecting both its cultural fabric and the existing residents living in it.<sup>102</sup>

## Conclusion

This paper has argued for the practice of urban curating as it relates to migrant communities within sites of urban change. Urban curating allows for a detachment of notions of care from the rational abstractions of policymaking and operates as an alternative activating practice, within reach of migrant communities.<sup>103</sup> It is a tool for the powerless to lead the conversation about the future of their cities and allows vulnerable populations to lay claim to urban spaces for themselves.

The future of Pilsen and its relationship with its Mexican hinterlands is articulated by the National Museum of Mexican Art. Within the Museum building and across a transnational urban entanglement, urban curating is a way in which the Mexican community, not of Mexico or Chicago, but of Pilsen, has understood how to care for itself and its expanding territory. Through its curatorial work, the NMMA has enabled a hub of artists and activists to use their voice to shape and lay claim to their borderlands.

---

100 The artists are part of Pilsen Alliance and used the exhibition space to protest against the alderman Daniel Solis and gentrification brought forward by housing developer The Resurrection Project. The leader of Pilsen Alliance was recently elected as alderman to replace Solis. “Our Response to Peeling off the Grey,” *Plus Gallery Chicago* [blog], May 13, 2018, <https://plusgallerychicago.com/2018/05/12/our-response-to-peeling-off-the-grey/> [accessed ...]

101 “Pilsen and Little Village Preservation Strategy,” *City of Chicago*, [https://www.chicago.gov/content/city/en/depts/dcd/supp\\_info/pilsen-and-little-village-preservation-strategy0.html](https://www.chicago.gov/content/city/en/depts/dcd/supp_info/pilsen-and-little-village-preservation-strategy0.html) (accessed May 4, 2020).

102 The Affordable Requirement Ordinance goes beyond the protection of the built environment and requires developers to allocate 20% of new units for lower-income residents, double the standard proportion across the city “Pilsen and Little Village Preservation Strategy.”

103 Handler, “Ageing, Care and the Practice of Urban Curating,” 195.

Through the use of urban curating as a way of care for and by migrant communities, the NMMA provides learnings for diasporic urbanisms elsewhere.<sup>104</sup> The practice of urban curating cuts across time and space, and engages the transnational territory that encompasses migrants' everyday urban existence. Pilsen and the National Museum of Mexican Art are clear examples of how art and culture have redefined the conditions under which urban transformation is contested and reframed. Urban curating proves to be a critical tool to render visible the hidden narratives of minority communities and shine a light on civic knowledge that is often unheard or overlooked in traditional planning and design processes. Using urban curating as "creative expression and everyday resistance," Mexican Pilsen has understood how to care for itself and its "migrant urbanisms", and provides learnings for other diasporic communities across the globe.<sup>105</sup>

---

104 Awan, *Diasporic Agencies: Mapping the City Otherwise*.

105 Suzanne M. Hall, "Migrant Urbanisms: Ordinary Cities and Everyday Resistance", *Sociology* 49, no. 5 (October 1, 2015), 1.

**Guillermo Ruiz de Teresa** is an architect and urban researcher whose work focuses on the intersection of space, the state and power. He trained as an architect at the Architectural Association School of Architecture, London and Universidad Iberoamericana, Mexico City, and received a Master in Design Studies from Harvard University's Graduate School of Design. He is currently based in London, where he is a Stavros Niarchos Foundation PhD scholar at the Royal College of Art's School of Architecture.



## References

- **Interviews:**

Omar Lopez, in discussion with the author, Chicago, April 2019.

Cesareo Moreno, in discussion with the author, Pilsen, April 2019.

Carlos Tortolero, in discussion with the author, Pilsen, June 2019.

Nancy Villafranca-Guzman, in discussion with the author, Chicago, May 2019.

- National Museum of Mexican Art. National Museum of Mexican Art, Exhibition Schedule, 1983 - 2019.
- National Museum of Mexican Art Records, 2019.
- National Museum of Mexican Art, and Julian Samora Library at the Institute for Latino Studies (University of Notre Dame). National Museum of Mexican Art Records, 1983.

"About Altamanu Landscape Architecture." <http://www.altamanu.com/about> (accessed May 4, 2020).

Akey, Lisa J. "Community Canvas: The Murals of Pilsen, a Chicago Neighborhood," PhD thesis (Indiana University, 2008).

Altschuler, Bruce. *The Avant-Garde in Exhibition: New Art in the 20th Century*. New York: Abrams, 1994.

Anzaldúa, Gloria E. *Borderlands/La Frontera: the New Mestiza*, 4th ed. San Francisco: Aunt Lute Books, 2012.

Arceo-Frutos, René H. *René Arceo: Between the Instinctive and the Rational*. Chicago, IL: Casa Michoacán en el Medio Oeste, 2010.

Ashton, Jenna C. *Feminism and Museums: Intervention, Disruption and Change*. Volume 2. Edinburgh: MuseumsEtc, 2018.

Awan, N. *Diasporic Agencies: Mapping the City Otherwise*. Burlington, VT; Farnham: Ashgate, 2016. <https://doi.org/10.4324/9781315577029>.

Charlotte Bates, Rob Imrie and Kim Kullman eds. *Care and Design: Bodies, Buildings, Cities*, Chichester: John Wiley & Sons, 2016. <https://doi.org/10.1002/9781119053484>.

Betancur, John, and Janet Smith. *Claiming Neighborhood: New Ways of Understanding Urban Change*. Chicago, IL: University of Illinois Press, 2016. <https://doi.org/10.5406/illinois/9780252040504.001.0001>.

Bhabha, Homi K. *The Location of Culture*. London: Routledge, 2012. <https://doi.org/10.4324/9780203820551>.

Bodo, Simona. "Museums as Intercultural Spaces," in *A Museum Studies Approach to Heritage*, edited by Sheila Watson, Amy Jayne Barnes and Katy Bunning. London: Routledge, 2018. <https://doi.org/10.4324/9781315668505-40>.

Bodo, Simona, Kirsten Gibbs and Margherita Sani eds. *Museums as Places for Intercultural Dialogue: Selected Practices from Europe*, Dublin: Park Printing, 2009.

- Borrelli, Nunzia, and Kathleen Adams. "Analysing Pilsen Mexican Neighbourhood in Chicago through the Lens of Competitiveness and Social Cohesion." In *Moving Cities - Contested Views on Urban Life*, edited by Lúgia Ferro et al. Wiesbaden: Springer, 2018, 133-51. [https://doi.org/10.1007/978-3-658-18462-9\\_9](https://doi.org/10.1007/978-3-658-18462-9_9).
- Bourdieu, Pierre. *The Field of Cultural Production: Essays on Art and Literature*, edited by Randal Johnson. New York: Columbia University Press, 1993.
- Bunschoten, Raoul. "Stirring Still: The City Soul and Its Metaspaces." *Perspecta* 34 (2003): 56-65.
- . "Urban Gallery, Urban Curation," CORP Symposium, 2004.
- Clifford, James. "Museums as Contact Zones," in *Routes: Travel and Translation in the Late Twentieth Century*, edited by James Clifford, Cambridge, Mass: Harvard University Press, 1997, 188-219.
- Crooke, Elizabeth. *Museums and Community: Ideas, Issues and Challenges*. London: Routledge, 2008. <https://doi.org/10.4324/9780203371015>.
- Davalos, Karen Mary. *Exhibiting Mestizaje: Mexican (American) Museums in the Diaspora*. Albuquerque, NM: University of New Mexico Press, 2001.
- Duncan, Carol. "Art Museums and the Ritual of Citizenship," in *Exhibiting Cultures: The Poetics and Politics of Museum Display*, edited by Ivan Karp, Steven Lavine, and Smithsonian Institution. Washington, DC: Smithsonian Institution Press, 1991, 88-103.
- Karp, Ivan, Steven Lavine, and Smithsonian Institution eds. *Exhibiting Cultures: The Poetics and Politics of Museum Display*. 2nd edition. Washington, DC: Smithsonian Institution Press, 1991.
- El Paseo Trail. "FAQ," January 19, 2019. <https://elpaseotrail.org/faq/>.
- Fernández, Lilia. *Brown in the Windy City: Mexicans and Puerto Ricans in Postwar Chicago*. Chicago, IL: University of Chicago Press, 2012. <https://doi.org/10.7208/chicago/9780226244280.001.0001>.
- Ganz, Cheryl, and Margaret Strobel. *Pots of Promise: Mexicans and Pottery at Hull-House, 1920-40*. Chicago, IL: University of Illinois Press, 2004.
- Gonzalez, Jose Gamaliel. *Bringing Aztlan to Mexican Chicago: My Life, My Work, My Art*. Chicago, IL: University of Illinois Press, 2010.
- Gough, Tim. "Cura," In *Curating Architecture and the City*, edited by Sarah Chaplin and Alexandra Stara. London: Routledge, April 16, 2009. <https://doi.org/10.4324/9780203876381-14>.
- Grams, Diane. *Producing Local Color: Art Networks in Ethnic Chicago*. Chicago, IL: University of Chicago Press, 2010. <https://doi.org/10.7208/chicago/9780226305233.001.0001>.
- Hall, Suzanne M. "Migrant Urbanisms: Ordinary Cities and Everyday Resistance," *Sociology* 49, No.5 (October 1, 2015). <https://doi.org/10.1177/0038038515586680>.
- Handler, Sophie. "Ageing, Care and the Practice of Urban Curating," in *Care and Design: Bodies, Buildings, Cities*, edited by Charlotte Bates, Rob Imrie and Kim Kullman Chichester. John Wiley, 2017, 178-197. <https://doi.org/10.1002/9781119053484.ch10>.
- Hooper-Greenhill, Eilean. *Museums and the Interpretation of Visual Culture*. New York: Routledge, 2000.
- Inzulza-Contardo, Jorge. "'Latino Gentrification'? Focusing on Physical and Socioeconomic Patterns of Change in Latin American Inner Cities," *Urban Studies* 49, no. 10 (2012): 2085-2107. <https://doi.org/10.1177/0042098011423425>.
- Jirasek, Rita Arias, and Carlos Tortolero. *Mexican Chicago*. Mount Pleasant, SC: Arcadia Publishing, 2001.

- Jones, Peter Blundell, Doina Petrescu, and Jeremy Till. *Architecture and Participation*. New York: Taylor & Francis, 2005.
- Kinard, John R. "The Neighbourhood Museum as a Catalyst for Social Change," *Museum International* 37, no. 4 (1985): 217-23. <https://doi.org/10.1111/j.1468-0033.1985.tb00592.x>.
- Kistemaker, Renee. *City Museums as Centres of Civic Dialogue? Proceedings of the Fourth Conference of the International Association of City Museums, Amsterdam, 3-5 November 2005*, Amsterdam: Amsterdam Historical Museum, 2006.
- Krasny, Elke. "Neighbourhood Claims for the Future: Feminist Solidarity Urbanism in Vancouver's Downtown Eastside," in *The Social (Re)Production of Architecture.*, edited by Doina Petrescu and Kim Trogal. New York: Routledge, 2017, 96-107. <https://doi.org/10.4324/9781315717180-7>.
- Krasny, Elke, Meike Schalk, and Meike Schalk. "Resilient Subjects: On Building Imaginary Communities," in *Architecture and Resilience: Interdisciplinary Dialogues*, edited by Kim Trogal, 93-112. New York: Routledge, 2018, <https://doi.org/10.4324/9781315159478-14>.
- Fitz, Angelika and Elke Krasny eds. *Critical Care: Architecture and Urbanism for a Broken Planet*, MA: MIT Press, 2019. <https://doi.org/10.7551/mitpress/12273.001.0001>.
- "Latino Youth: Living With HIV/Aids in the Family", National Museum of Mexican Art. <http://nationalmuseumofmexicanart.org/exhibits/latino-youth-living-hiv-aids-family> (accessed May 3, 2020).
- Lopez-Gonzalez, Crescencio. *The Latinx Urban Condition: Trauma, Memory, and Desire in Latinx Urban Literature and Culture*. Lanham, MD: Rowman & Littlefield, 2019.
- Martinon, Jean-Paul. *The Curatorial: A Philosophy of Curating*. London: A&C Black, 2013.
- Morales, Ed. *Latinx: The New Force in American Politics and Culture*. London; Brooklyn, N.Y.: Verso, 2018.
- Mora-Torres, Juan. "Pilsen: A Mexican Global City in the Midwest," *Diálogo* 9, no.1, article 2 (2005).
- Obrist, Hans-Ulrich, and Lionel Bovier. *A Brief History of Curating*. Zürich: JRP / Ringier, 2008.
- O'Neill, Paul. "The Curatorial Turn: From Practice to Discourse," in *Issues in Curating Contemporary Art and Performance*, ed. Judith Rugg and Michèle Sedgwick (Bristol: Intellect Books, 2007), 13-28.
- Plus Gallery Chicago. "Our Response to Peeling off the Grey," May 13, 2018. <https://plusgallerychicago.com/2018/05/12/our-response-to-peeling-off-the-grey/> (accessed May 4, 2020).
- "Peeling off the Grey", *National Museum of Mexican Art*. <http://nationalmuseumofmexicanart.org/exhibits/peeling-grey> (accessed May 4, 2020).
- Penman-Lomeli, Andrea. "Developers Literally Whitewashed a Chicago Neighborhood's Historic Latino Murals," *CityLab*. <https://www.citylab.com/politics/2017/06/the-literal-whitewashing-of-chicagos-latino-murals/531156/> (accessed May 3, 2020).
- Pero, Peter N. *Chicago's Pilsen Neighborhood*. Mount Pleasant, SC: Arcadia Publishing, 2011.
- Petrescu, Doina. *Altering Practices: Feminist Politics and Poetics of Space*. London: Routledge, 2007. <https://doi.org/10.4324/9780203003930>.
- Petrescu, Doina, and Kim Trogal. "Introduction: The Social (Re)Production of Architecture in 'Crisis-Riddled' Times," in *The Social (Re)Production of Architecture: Politics, Values and Actions in Contemporary Practice*, edited by Doina Petrescu and Kim Trogal. New York: Routledge, 2017. <https://doi.org/10.4324/9781315717180-1>.

- "Pilsen and Little Village Preservation Strategy." City of Chicago. Accessed May 4, 2020. [https://www.chicago.gov/content/city/en/depts/dcd/supp\\_info/pilsen-and-little-village-preservation-strategy0.html](https://www.chicago.gov/content/city/en/depts/dcd/supp_info/pilsen-and-little-village-preservation-strategy0.html).
- Puwar, Nirmal, and Sanjay Sharma. "Curating Sociology," *The Sociological Review* 60, no. 1\_suppl (June 1, 2012): 40-63. <https://doi.org/10.1111/j.1467-954X.2012.02116.x>.
- Ramirez, Leonard G. *Chicanas of 18th Street: Narratives of a Movement from Latino Chicago*. Chicago, IL: University of Illinois Press, 2011.
- Romo, D. Harriett and Olivia Mogollon eds. *Mexican Migration to the United States: Perspectives from Both Sides of the Border*, Austin, TX: University of Texas Press, 2016.
- Rugg, Judith and Michèle Sedgwick eds. *Issues in Curating Contemporary Art and Performance*, Bristol: Intellect Books, 2007.
- Sandoval-Strausz, A. K. *Barrio America: How Latino Immigrants Saved the American City*. New York, NY: Basic Books; Hachette Book Group, 2019.
- Schalk, Meike. "Urban Curating: A Critical Practice Towards Greater Connectedness," in *Altering Practices: Feminist Politics and Poetics of Space*. New York: Routledge, 2007, 153-65.
- Schuerman, Matthew L. *Newcomers: Gentrification and Its Discontents*. Chicago, IL: University of Chicago Press, 2019.
- Simon, Nina. *The Participatory Museum*. Santa Cruz, CA: Museum 2.0, 2010.
- Tronto, Joan C. *Moral Boundaries: a Political Argument for an Ethic of Care*. New York; London: Routledge, 2015.
- Tronto, Joan C., and Berenice Fisher. "Toward a Feminist Theory of Caring," In *Circles of Caring*, edited by E. Abel and M. Nelson (Albany, NY: SUNY Press, 1990, 36-54.
- Villafranca-Guzmán, Nancy, and Carlos Tortolero. "The National Museum of Mexican Art: A New Model for Museums" *The Journal of Museum Education* 35, no. 1 (2010): 83-92.
- Westen, Mirjam. "Jeanne van Heeswijk: The Artist as Versatile Infiltrator of Public Space - 'Urban Curating' in the 21st Century," *n.paradoxa* no. 12 (2003): 24-32.
- Zavala, Antonio. *Memorias de Pilsen: Recuerdos de Lucha de un Barrio Mexicano en Estados Unidos*. s.l.: Tenoch Press, 2018.
- . "Otras Ondas section [Casa Aztlán: Focus of Cultural Expression in the Midwest]." *Mirarte* (October 1, 1982), 4.

MAIN SECTION

# Curating Architecture and the City: Recent Australian Pavilions

Susan Holden — University of Queensland (Australia) — Contact: [s.holden@uq.edu.au](mailto:s.holden@uq.edu.au)

Ashley Paine — University of Queensland (Australia) — Contact: [a.paine@uq.edu.au](mailto:a.paine@uq.edu.au)

## ABSTRACT

In recent decades, pavilions have emerged as a popular vehicle for exhibitions of architecture: these often spectacular structures and immersive environments becoming both the object and subject of display. Yet, despite their ubiquity, and the increasing interest of art galleries and institutions in exhibiting and commissioning architectural projects, the pavilion has largely escaped interrogation within the discourse and practice of curation. Taking three recent Australian pavilion programs as its focus, this essay examines the diverse challenges of curating this kind of full-scale architecture, and the ways in which architecture is curated in or through them. In particular, the Australian pavilions raise important questions concerning the curatorial work: what is being curated, by whom, and to what ends? Such questions are critical to understanding the changing place of architecture in contemporary culture, but also the limits and opportunities presented by architecture in an ever-widening field of curation.

## KEYWORDS

*Pavilion; Curation; Curating Architecture; Architecture Exhibition*

## PEER REVIEWED

<https://doi.org/10.6092/issn.2612-0496/10140>

ISSN 2612-0496

Copyright © 2020 Susan Holden, Ashley Paine

## Pavilions and the possibility of curating architecture

In 2014 Julia Peyton-Jones, celebrated curator and, at that time, co-director of the Serpentine Galleries in London opened the inaugural Sean Godsell-designed MPavilion in Melbourne with the remark: "It's exciting that our annual pavilion now has a twin in Australia."<sup>1</sup> Instigated by the philanthropist Naomi Milgrom through her Naomi Milgrom Foundation with sponsorship from the City of Melbourne, the MPavilion is part of a global proliferation of pavilion programs that have emerged in the wake of the annual Serpentine Pavilions that pop-up in London's Hyde Park each summer. The MPavilion follows a similar formula, inviting a high-profile architect to realize a temporary structure in Melbourne's Queen Victoria Gardens for the summer months, as both an immersive exhibition of architecture and a setting for an extensive program of free cultural events. It has garnered much attention since the delicate aluminum mesh walls of Godsell's pavilion were first lifted over a curious crowd.

The MPavilion is one of several programs that have become part of the cultural scene in Australia in recent years. In 2013, gallerist and philanthropist Gene Sherman, also inspired by the Serpentine Pavilions, initiated *Fugitive Structures*, an annual series of temporary structures designed for the courtyard of Sherman Contemporary Art Foundation (SCAF) in Sydney, which ran from 2013-2016. While in 2015, the National Gallery of Victoria (NGV) took the model into a state institution, initiating an annual Architecture Commission for an ephemeral structure to be realized in its Grollo Equiset Garden courtyard. The commission has since become a key project of the Gallery's new Department of Contemporary Architecture and Design, also established in 2015.

These Australian programs attest to the multi-faceted ways in which the Serpentine model has proliferated in a range of institutional contexts and physical settings. More than this, the diversity of the Australian programs highlights how the contemporary pavilion has emerged as an object of curation—evidencing both the recent popularity of architecture as a subject of exhibitions and, more generally, the expansion of the role of the curator, and of curating, as an activity of contemporary culture. In the discipline of architecture itself, the case for a dedicated discourse of architectural curation has been made by Cynthia Davidson in a 2010 special edition of *Log Journal* dedicated to the topic.<sup>2</sup> Moreover, the professionalisation of the field is demonstrated by such programs as Columbia University's Graduate School of Architecture, Planning and Preservation (GSAPP) which offers a Master degree in Critical, Curatorial, and Conceptual Practices in Architecture. Importantly, however, these are

---

1 Quoted in Linda Cheng, "Sean Godsell's MPavilion Unfurled," *ArchitectureAU*, 6 October 2014, <https://architectureau.com/articles/mpavilion-opens/>.

2 Cynthia Davidson, ed. *Log 20: Curating Architecture* (2010).

all but a small part of what David Balzer has described more generally as an “acceleration of the curatorial impulse” that has occurred since the mid-1990s.<sup>3</sup>

Furthermore, pavilions—especially those commissioned and built by art galleries and museums—must also be seen in the broader context of the spectacularisation of art, and the shift in recent decades towards the curation of single, large-scale artworks often presented as exhibitions in which they are the only object on display. Here, the curatorial act is one of selecting, commissioning and midwifing often temporary artworks for institutional spaces. But, at the same time, pavilions can appear to escape the reach of curation. As relatively unmediated exhibitions of architecture, their apparent need and capacity for curation is diminished: the pavilion is often understood as a kind of exhibition that does not require curation, where the chosen architect is commissioned and the creative act of their design stands on its own. It is perhaps for this reason that they are somewhat overlooked or dismissed in the art world,<sup>4</sup> and have largely eluded interrogation through the theme of curation.

In fact, much of the rhetoric around the contemporary pavilion as a format for the exhibition of architecture has focused on its capacity to exhibit architecture directly, at 1:1 scale. In this respect they appear to overcome the problems that have typically been associated with the exhibition of architecture. As Jean-Louis Cohen, former director of the Cité de l’Architecture et du Patrimoine in Paris, has suggested in his often-cited discussion of the dilemma of exhibiting architecture:

Exhibiting art is usually involved in showing the work. Exhibiting architecture is a matter of showing indices of something which, when the work is built, is out there. In French there are two terms translated as “work.” One is *ouvrage*, referring to the built work; and one is *oeuvre*, referring to the project, the design, the intellectual work. ... So relating the documentation of the work/oeuvre to the work/ouvrage on the wall or somewhere is one of the challenges of architectural exhibitions.<sup>5</sup>

In this context, the contemporary pavilion has emerged as a perfect vehicle to overcome the oeuvre/ouvrage disjunction. Julia Peyton-Jones, who led the Serpentine Pavilion program from 2000 until her departure in 2016, has often emphasized this point as a way to explain the logic of the Serpentine Pavilions as exhibitions of themselves<sup>6</sup>—a point she

---

<sup>3</sup> David Balzer, *Curationism: How Curating Took Over the Art World and Everything Else* (Toronto: Coach House Books, 2014), 8.

<sup>4</sup> One of the key exceptions to this is: Joel Robinson, ed. *Open Arts Journal Issue 2: Pavilions* (2013).

<sup>5</sup> Yve-Alain Bois, Denis Hollier, Rosalind Krauss, and Jean-Louis Cohen, “A Conversation with Jean-Louis Cohen,” *October* 89 (1999): 6.

<sup>6</sup> Philip Jodidio, “Interview with Julia Peyton-Jones and Hans Ulrich Obrist,” in *Serpentine Gallery Pavilions*, ed. Philip Jodidio (Köln: Taschen, 2011), 16.



FIG. 1 Bjarke Ingels Group (BIG), 2016 Serpentine Pavilion, London. Source: Photograph by Ashley Paine, 2016

reiterated at the opening of Godsell's MPavilion in describing the pavilion as "exhibiting architecture through built space rather than in an exhibition."<sup>7</sup> [Fig. 1]

At the same time, Peyton-Jones has spoken about the process of commissioning architects for the Serpentine Pavilions as an extension of the way the gallery developed a practice of commissioning artists to make site-specific works for the gallery during the 1990s.<sup>8</sup> The Serpentine Pavilion program has certainly, over time, exploited the disciplinary ambiguity that lingers around the pavilions. On the one-hand, they are an accessible form of art exhibition that brings new audiences to the gallery, on the other, they are, in the words of Peyton-Jones herself, "the new wing we build each year."<sup>9</sup> Construed as a form of large-scale site-specific art makes sense of their seriality and temporariness, except that few of the pavilions have been site-specific in the way that architects use this concept and have typically been relocated to new homes after their Serpentine seasons. The pavilions thus highlight a key question concerning the

7 Cheng, "Sean Godsell's MPavilion Unfurled".

8 Jodidio, "Interview with Julia Peyton-Jones and Hans Ulrich Obrist," 8. See also: Susan Holden, "'To be with architecture is all we ask': A critical genealogy of the Serpentine Pavilions," in *Quotation Quotation: Proceedings of the 34<sup>th</sup> Annual Conference of the Society of Architectural Historians of Australia and New Zealand*, eds. Gevork Hartoonian and John Ting (Canberra: SAHANZ, 2017), 255-266.

9 Jodidio, "Interview with Julia Peyton-Jones and Hans Ulrich Obrist," 16.



constraints and particularities associated with the exhibition of architecture: what does it mean for architecture to be curated?

The Serpentine Pavilions elevates the role of the curator in several significant ways. The Artistic Directors of the Gallery—Peyton-Jones (until 2016) and Hans Ulrich Obrist (co-director from 2006, and then director from 2016)—assume a prominent place alongside the architects, as creators, if not of the pavilion designs, then certainly of the contemporary pavilion as a format.<sup>10</sup> In addition to the realization of the pavilions themselves, there is also the curatorial work associated with programming the events that have become inextricably linked with the pavilions since the arrival of Obrist and his introduction of the 24-hour Serpentine Marathon talk-fest that first ran in conjunction with the Rem Koolhaas and Cecil Balmond Pavilion under its crowning balloon of hot air. Certainly, the activity of curating has changed alongside the evolution of art practices in the later part of the twentieth century. Where once “curator” referred to a custodian of a collection, or someone who managed a museum, since the 1980s usage has expanded to embrace such activities as selecting “performers or performances to be included in a festival, album, programme” or more simply, “selecting, organizing and presenting content.”<sup>11</sup> Hence, “curating” today is a nebulous array of activities that encompasses a diverse set of tasks that might previously have been described as arts management, funding, producing, directing, commissioning, editing, programming, planning and criticism.

Obrist’s trajectory as an über curator has been significantly propelled by the Serpentine Pavilions, and he has become a key figure in contemporary architectural culture through his curatorial activities, including his involvement in the Venice Architecture Biennale. His *Interview Project and Unbuilt Project*—which have no or little material expression—attests to his power to foreground curating as a primary cultural activity. This is something he has also done through numerous books on curating, which Daniel Birnbaum describes in the postface to Obrist’s *A Brief History of Curating*, as articulating an expanded spectrum of curation. According to Birnbaum, this spectrum, is defined at one extreme by Pontus Hultén’s reinvention of the cultural institution from within and, at the other, by Harold Szeemann’s reinvention of the concept of the exhibition through his wide-ranging freelance work.<sup>12</sup> Sylvia Lavin’s remark that “Obrist curates curation” is an apt description of the way he has claimed not only the activity but the topic as well.<sup>13</sup>

10 Obrist has suggested that Julia Peyton-Jones effectively “invented” the pavilion in 2000 with Zaha Hadid. See: Julian Rose et al., “Trading Spaces: A Roundtable on Art and Architecture,” *Artforum International* 51, no. 2 (2012): 204.

11 This shift is noted in the OED’s Draft Additions from July 2011. See: “curate, v.,” in *Oxford English Dictionary Online*.

12 Birnbaum, Daniel postscript to Hans Ulrich Obrist, *A Brief History of Curating* (Zurich: JRP | Ringier; Dijon: Les Presses du réel, 2008), 238.

13 Sylvia Lavin, “Showing Work,” *Log 20: Curating Architecture* (Fall 2010): 7.

If the contemporary pavilion is one of the most significant instances of the exhibition of architecture in the contemporary scene, it still remains to be understood in what ways architecture, and the city itself, is curated in or through them, and how they might indicate the limits of architecture's capacity to be curated. Like the Serpentine Pavilions, all of the Australian pavilion programs involve the work of curators, but in ways that are not always obvious. Rather, they tend to be idiosyncratically shaped by their specific institutional and funding contexts, and their specific sites, which range from private and public galleries to a public park. The following analysis of the Australian pavilion programs aims to open up such a discussion, and give a more nuanced picture of how the activity of curating architecture takes place in the pavilions.

### **The MPavilion: Curating the city**

Of all the Australian pavilion commissions, the MPavilion most closely follows the Serpentine Galleries' model through their direct commissioning by Milgrom and her team.<sup>14</sup> They are realized as discrete structures that capitalize on the name and reputation of the chosen architect, and play a recognized game of distilling the architect's oeuvre while maintaining an experimental edge. They also most seriously engage with the event programming aspect of the Serpentine model.

Perhaps in a more significant way than the Serpentine Pavilions, the MPavilions have a role in giving a tangible presence to the Naomi Milgrom Foundation, at least for the summer months when they sit in Queen Victoria Gardens in Melbourne's Southbank Arts Precinct. More than just a "new wing," they become the primary architectural statement of the Foundation and its mission to cultivate a discourse on design in the city. The pavilions are capital 'A' architecture, despite being peripatetic, and have been designed by a series of high-profile architects with international reputations: Sean Godsell (2014), Amanda Levete of AL\_A (2015), Bijoy Jain of Studio Mumbai (2016), Rem Koolhaas and David Gianotten of OMA (2017), Carme Pinós (2018) and, most recently, Glenn Murcutt (2019). What is interesting, however, is that while Milgrom has a long history of engagement with the arts, she is not a professional curator: her role in the MPavilion blurs the lines between commissioning and curating.<sup>15</sup> Much like the curators of the Serpentine Pavilions, Milgrom has established herself as a creative presence in the program, frequently appearing in photographs alongside the pavilions' architects.

---

14 Naomi Milgrom acknowledges the Serpentine Pavilion program as an inspiration for the MPavilion projects. Heidi Dokulil, "How the MPavilion is reshaping how we see the city," 2 November 2016 <https://morespace.spacefurniture.com/latest-news/2016/10/31/how-the-mpavilion-is-reshaping-how-we-see-the-city>; Cheng, "Sean Godsell's MPavilion Unfurled"; "Naomi Milgrom Foundation," <http://mpavilion.org/about/naomi-milgrom-foundation/>.

15 Lisa Clausen, "A city's celebration of lives less ordinary, Naomi Milgrom and MPavilion," *Age*, <https://www.theage.com.au/national/victoria/a-citys-celebration-of-lives-less-ordinary-naomi-milgrom-and-mpavilion-20141203-11zh3s.html>.

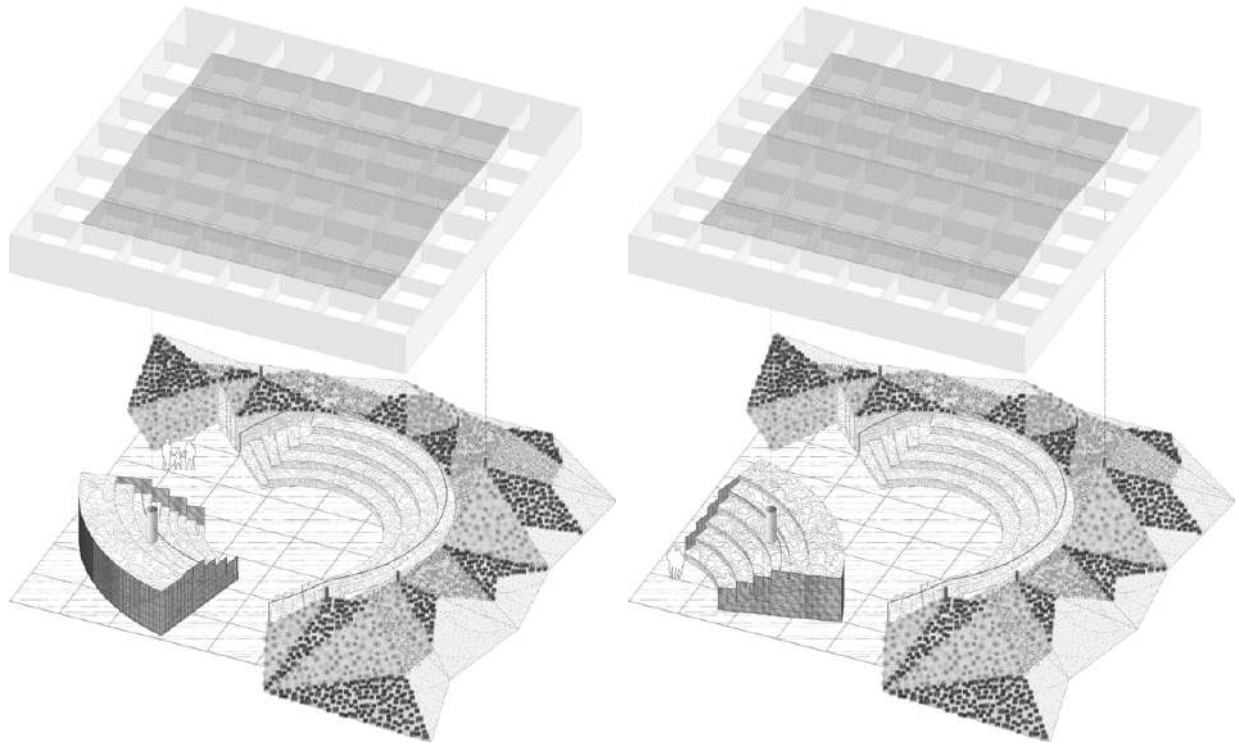

FIG. 2 Rem Koolhaas and David Gianotten / OMA, 2017 MPavilion, Melbourne. Source: Photograph by Ashley Paine, 2017

Moreover, the “M” in “MPavilion” which ostensibly refers to the city of Melbourne, fortuitously also implies Milgrom’s own name, and is a reminder of her role as the commissioner and instigator of the program. It also highlights the public-private-partnership model through which the civic realm is now increasingly made [Fig. 2].

Drawing upon a diverse and shifting group of government, industry, education and cultural partners, the MPavilion is supported each year by a team of events programmers and production assistants that play an important role in the curation of the pavilion’s events program, which extends across the Summer, and includes talks on topics as diverse as cities, philosophy and astronomy as well as a range of events, installations, performances and children’s activities. As such, the pavilion designs are often concerned with the spatial arrangement of their gatherings: they demonstrate a range of counterforms—archetypal or avant-garde—that anticipate a crowd. Studio Mumbai’s design, for example, provided a generous roofed space with a symbolic central void, while Koolhaas’s amphitheater-like design incorporated a small rotating grandstand that could turn towards the center of the pavilion or out to the park [Figs. 3a-3b].

The MPavilion programming also has a specific agenda to curate conversations about architecture and in all cases the architects have been involved in the events. In 2017 Koolhaas and Gianotten contributed to the curation of the programming which included a Regional Program,



FIGS. 3A-B 3a Rem Koolhaas and David Gianotten / OMA, 2017 MPavilion, Melbourne. Source: Courtesy OMA.

following an explicit research interest of OMA.<sup>16</sup> Another program offshoot is the Living Cities Forum, an annual event organised by the Naomi Milgrom Foundation held in Melbourne in advance of the construction of the Pavilion. The Living Cities Forum has a more serious ambition to engage with topics of city making. It is an example of the event programming escaping the pavilion and becoming a primary curatorial endeavor.<sup>17</sup>

Despite many similarities, the MPavilions differ from the Serpentine Pavilions in the way they are ultimately distributed across the city, intended as new pieces of civic infrastructure. After their short life in Queen Victoria Gardens over the summer, each of the MPavilions is intended to have a second life, relocated to sites around Melbourne. Godsell's Pavilion was relocated to the Hellenic Museum, Leveté's to a park in the inner-city Docklands redevelopment, Studio Mumbai's to Melbourne Zoo, OMA's to Monash University and Murcutt's will find a new home at Melbourne University. This is different from the Serpentine Pavilions which are sold in advance to fund their construction, often to gallery benefactors, art collectors, estate owners or urban developers who have the wherewithal to move them, and the space to put them.<sup>18</sup>

16 Tania Davidge, "2018 MPavilion - Naomi Milgrom & Carme Pinós," 13 February 2018, <http://archiparlour.org/2018-mpavilion-milgrom-pinos/>.

17 This is also the point made by Andrea Phillips in her examination of the Serpentine Pavilions. See: Andrea Phillips, "Pavilion Politics," *Log 20: Curating Architecture* (Fall 2010).

18 At least one pavilion—Zaha Hadid's *Lilas* from 2017—subsequently entered the art market via a Sotheby's sale of "monumental outdoor sculpture" in 2016. See: Ben Luke, "Zaha Hadid's *Lilas* in Bloom," *Sotheby's Magazine*, 12 September 2016, <http://www.sothebys.com/en/auctions/2016/beyond-limits-116010.html>.



FIG. 4 ALA, 2015 MPavilion, relocated to Docklands Park, Melbourne in 2016. Source: Photograph by Ashley Paine, 2016

Indeed, in the repetition of the commission and in the dispersal of the pavilions, it is possible to identify another curatorial activity, one that plays out not only temporally, over the life-span of the project, but also spatially over the city of Melbourne. This is not necessarily about organizing a series of related works (the pavilions as a set are, after all, incredibly eclectic), or bringing them into an interpretative framework (the sites of the relocated pavilions have no pre-ordained relationship). Nor does it make the MPavilion like the kind of serial pavilion projects of the 1990s, such as Parc de la Villette, with their unifying themes, internal logics, and controlled sites. It does, however, suggest a curatorial activity that sits above the individual pavilion designs and has a strategic, even creative intent [Fig. 4].

One way to understand this intent is as an ambition to curate the city itself. Milgrom wants the relocated pavilions to be moments of good design that invite engagement in the civic realm (even though the pavilions are designed without fore-knowledge of their ultimate sites). But more than

this, Milgrom wants to have a tangible impact on the future design of the city. If the Living Cities Forum is meant to set an agenda for good urban design, then the MPavilion is intended as a catalyst for its realization. Through the MPavilion program, urban design is presented as a curatorial task: orchestrating project opportunities, highlighting design quality, and cultivating an interested and informed public. As such, the pavilion structures emerge as a means to opportunistically operate directly upon the urban fabric of the city, which is understood here as a dynamic and evolving palimpsest of buildings and spaces, a “collection to be curated.”<sup>19</sup> Milgrom herself emerges as a figure directly involved in shaping the city.

### The NGV’s Architecture Commission: Curating architecture in the gallery

Across St Kilda Road, the MPavilion’s institutional neighbor generates its own curatorial curiosities with its pavilion-building activities. Located in the sculpture garden of the NGV, the annual Architecture Commission invites the participation of designers through an open, two-stage competition. Unique amongst the Australian pavilions, it is an open competition in more ways than one. The commission brief welcomes multidisciplinary teams to produce a temporary, site-specific work of architecture in the broadest sense, whether that be a useful space or a functionless intervention into the landscape.<sup>20</sup> In either case, the design has been used as a catalyst (and venue) for a suite of related public programs and events [Fig. 5].

Despite this ambivalence to conventional architectural outcomes, the first two built works were decidedly of the pavilion genus: John Wardle Architects’ pink canopy *I Dips Me Lid* from 2015, and its chromatically consistent follow-up, *Haven’t you always wanted...?* by M@ STUDIO Architects in 2016. Both were discrete, self-contained structures that appear to occupy the garden more by coincidence than design, making formal references beyond the NGV site: to the Sidney Myer Music Bowl, and to a suburban car wash in Blackburn respectively.<sup>21</sup> Subsequent projects have been more diverse and have involved multi-disciplinary collaborations. In 2017 *Garden Wall* by Retallack Thompson and Other Architects, and in 2018 *Doubleground* by Muir + Openwork, took up the challenge of directly engaging with the NGV and its garden, while in 2019 *In Absence* by Yhonnie Scarce and Edition Office was an artist led collaboration

19 Sarah Chaplin and Alexandra Stara, “Introduction,” in *Curating Architecture and the City*, ed. Sarah Chaplin and Alexandra Stara (London; New York: Routledge, 2009), 2.

20 National Gallery of Victoria, “2018 NGV Architecture Commission Design Competition,” <https://www.ngv.vic.gov.au/explore/collection/curatorial/design-architecture/2018-ngv-architecture-commission-design-competition/>. Teams are required to be led by an Australian registered architect.

21 National Gallery of Victoria, “2015 Summer Architecture Commission: John Wardle Architects,” <https://www.ngv.vic.gov.au/exhibition/john-wardle-architects/>; National Gallery of Victoria, “2016 NGV Architecture Commission: M@STUDIO Architects,” <https://www.ngv.vic.gov.au/exhibition/2016-ngv-architecture-commission/>



FIG. 5 M@ Studio, 2016 NGV Architecture Commission, Haven't you always wanted...?, National Gallery of Victoria, Melbourne. Source: Photograph by Ashley Paine, 2016

that explored the history of Indigenous design industry and agriculture. In *Garden Wall* the designers framed the landscape with a labyrinth of scrim, creating rooms and passages for visitors to play a game of hide and seek with the gallery's outdoor sculpture collection.<sup>22</sup> In *Doubleground* the designers constructed a landscape that incorporated formal motifs derived from the Roy Grounds-designed host museum upon its fiftieth birthday [Figs. 6-7].

What is most interesting about the commission, however, is the competition process itself, which places the NGV's architectural program



FIG. 6 Muir + Openwork, 2018 NGV Architecture Commission Doubleground. National Gallery of Victoria, Melbourne. Source: Muir + Openwork and NGV

22 Susan Holden, "Refiguring the Pavilion: Garden wWall, 2017 NGV Architecture Commission by Retallack Thompson and Other Architects," *Australian and New Zealand Art Journal* 18, No. 1 (2018): 154-57.



FIG. 7 Muir + Openwork, 2018 NGV Architecture Commission Doubleground. National Gallery of Victoria, Melbourne. Source: Photograph by Susan Holden, 2018

in conflict with the very idea of curation. Despite its loose definition of architecture, and its placement in a dedicated garden for sculpture, its procurement via a competition situates the commission within the familiar disciplinary practices of architecture, rather than the curatorial procedures of the museum.<sup>23</sup> This is all the more striking given that the NGV is the only state gallery in the country to have a curatorial department dedicated to architecture and design. While the gallery says that the competition is “led” by the newly formed department, the design competition is developed and administered each year by an external consultant firm, CityLab.<sup>24</sup> Reassuringly, the NGV appears committed to the open process, and largely refrains from stacking the jury: the 2018 and 2019 panels, for example, included none of the department’s own staff—the NGV’s Deputy Director, Andrew Clark, was the sole gallery representative.<sup>25</sup> And, while in 2017, Ewan McEoin, Curator of Contemporary Design and Architecture, was the lone NGV participant in the selection process, the jury for the 2016 commission included no gallery staff at all.

23 There is at least one precedent for the use of the competition model for commissioning of pavilions. MoMA PS1’s Young Architects Program (YAP) is one of the best known annual “pavilion” programs, and uses an invited competition process to seek out young talented designers. Its jury, however, is largely constituted of MoMA curators. A useful by-product of the competition process is the production of a series of models, drawings and other presentation material that is also exhibited by MoMA. See: Museum of Modern Art, “Young Architects Program (YAP),” <https://www.moma.org/calendar/groups/8>; Matthew Messner, “Meet the finalists for the 2018 MoMA PS1 Young Architects Program,” 2 November, 2017, <https://archpaper.com/2017/11/finalists-ps1-yap/>

24 John Wardle Architects’ commission is an exception: the office was approached directly by the NGV for the project. National Gallery of Victoria, “The Making of the Inaugural Summer Architecture Series: John Wardle Architects,” <https://www.ngv.vic.gov.au/multimedia/the-making-of-the-inaugural-summer-architecture-series/>.

25 National Gallery of Victoria, “2018 NGV Architecture Commission Design Competition”.



It is perhaps for reasons of transparency and accountability that the NGV has turned to external juries and managers for the commissioning of building works using public funding—an obligation avoided by independent commissioners such as Milgrom, even though that program is also supported by public funds. However, such concerns are rarely exposed so nakedly in the gallery's day-to-day curatorial operations—it is almost unimaginable that such curatorial outsourcing would occur in any other department for such an important gallery commission. The architectural competition process effectively short-circuits the curatorial selection, control and expertise usually exercised over objects of display; the garden structures escaping the scrutiny of connoisseurship to find a backdoor into the gallery.

Ultimately this produces a paradoxical situation in which the NGV's curators in the Department of Contemporary Design and Architecture appear to miss out on an opportunity to have strategic oversight over the signature piece in their annual program. Even though it is seemingly the most curatable commission of all the Australian programs: its site forcibly places the architectural design amongst other works in the NGV's permanent collection and, in principle, provides an opportunity to situate architecture carefully and intelligently within the gallery's own curatorial agenda and exhibition programs. This potential of the NGV Architecture Commission is particularly conspicuous given its rescheduling in 2017 to coincide with the new NGV Triennial which, from its first iteration in December of that year, places art on display alongside architecture and design in one of the city's largest and most prominent exhibition events. As such, the winning design of the annual competition will be presented and seen every three years as a part of the Triennial—a key exhibitionary context for the project, but seemingly without the possibility of its strategic development in relation to that exhibition's overarching themes.

This is not to suggest, however, that curation does not have an important role to play in the NGV's Architecture Commission—only that most of the curatorial opportunities lie with the designers of the architectural project themselves. In particular, this agency comes from the chance to engage with the garden site and the existing sculpture collection; both are inherently curatorial decisions. Evidence of this is visible in the first installation by John Wardle Architects which staged the Henry Moore bronze, *Draped Seated Woman* (1958) beneath a canopy of color and, to a much greater extent, in the 2017 *Garden Wall*. The white translucent panels of this installation “curates” the sculpture collection and the garden using the principle framing device of the gallery itself: the white wall. As such, the project conflates its “curatorial” gestures with the scenographic and staging techniques of exhibition design. At the same time, the project demonstrates a strong resemblance to works by artist Robert Irwin, and adopts the well-established strategies of site-specific art. Certainly, there is nothing radical about this chameleon manoeuvre—of architecture

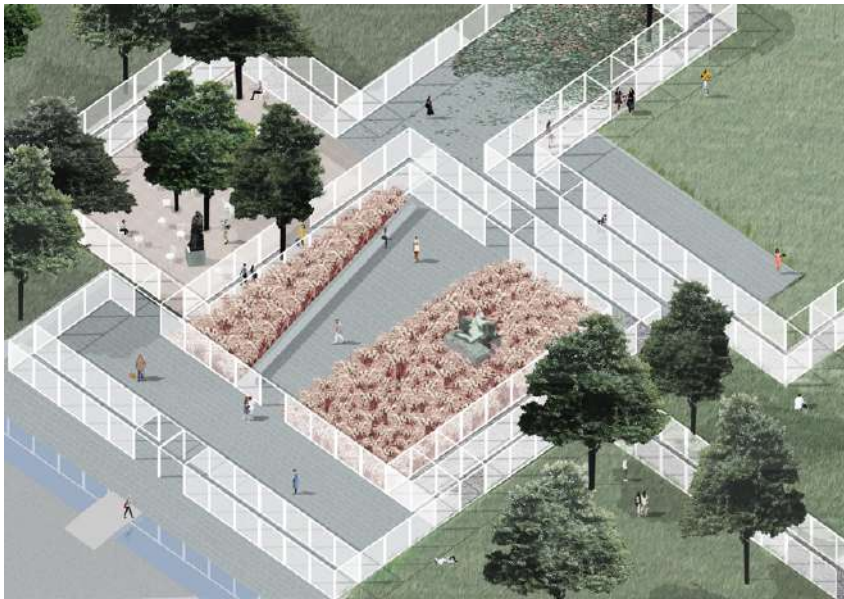

FIG. 8 Retallack Thompson and Other Architects, 2017 NGV Architecture Commission, Garden Wall, National Gallery of Victoria, Melbourne. Source: Retallack Thompson and Other Architects and NGV



FIG. 9 Retallack Thompson and Other Architects, 2017 NGV Architecture Commission, Garden Wall, National Gallery of Victoria, Melbourne. Source: Photograph by Susan Holden, 2017

masquerading as art—but in the case of *Garden Wall*, it allows the project to ingratiate itself and become one of the many sculptures exhibited in the garden. This is curation by stealth [Figs. 8-9]

While the NGV readily embraces the design ideas and intellectual content of each commission, the fact remains that the competition selection process gives the gallery little control over the architectural message at that important point of inception, rendering it all but useless for broader curatorial purposes. Any conceptual links between the annual commission

and the other works on show can only ever be coincidental.<sup>26</sup> Yet while the commissions themselves appear to elude curation by the Gallery, they re-emerge as vehicles for the experimental curatorial activities of the architect-designer-curator to operate within the setting of the institution, and work directly upon the NGV's collection and garden. As such, parallels may be drawn to wider trends within an expanded concept of curation: the curator emerging as an independent creator of exhibitions. Today it is a commonplace in the visual arts for freelance curators, and artists-as-curators, to operate on collections and in institutional contexts around the world, seeking novel ways to reinterpret and re-present them. The NGV's approach to the curatorial activities of its Architecture Commission seem to coincide with these expanded curatorial practices in contemporary art, where curation is no longer an invisible activity that sits over the work to provide it a cohesive narrative, but is now celebrated as a creative work in its own right. What is novel in the NGV Architecture Commission, is that this creative act of curation is embodied in the structures themselves.

### **SCAF's Fugitive Structures: Curating architecture and culture**

In contrast to the NGV Architecture Commission, the suite of four pavilions commissioned by the Sydney-based Sherman Contemporary Art Foundation (SCAF) between 2013 and 2016 under the title *Fugitive Structures*, represent the most tightly curated collection of pavilions in the Australian context. Based on the Serpentine Pavilion model, SCAF developed their own curatorial agenda for the pavilion program under the leadership of Artistic Director Gene Sherman, formalizing Sherman's long-standing interest in exhibiting a broad range of arts. Indeed, *Fugitive Structures* was not only the first Australian pavilion program (arriving a year before MPavilion, and two before the first NGV project), but it was preceded by a series of architectural projects commissioned and exhibited by SCAF, including a major installation in 2009 by Japanese architects Kazuyo Sejima and Ryue Nishizawa / SANAA.

For the *Fugitive Structures* projects, Sherman sought out early- to mid-career architects from Australia and the Asia-Pacific region, via an invited selection process, in line with the Foundation's commitment to developing exhibitions from the region otherwise not possible in commercial or public galleries.<sup>27</sup> The first structure *Crescent House* was designed by Andrew Burns in 2013, followed by *Trifolium* in 2014 by AR-MA, both

---

26 Linda Cheng, for example, has highlighted a resonance between *Garden Wall* and Richard Mosse's video installation included in the inaugural 2017 Triennial which showed scenes of the Syrian refugee crisis. Linda Cheng, "A landscape on an object: NGV's 2017 Architecture Commission opens," *ArchitectureAU*, 15 December 2017, <https://architectureau.com/articles/a-landscape-on-an-object-ngvs-2017-architecture-commission-opens/>.

27 Gene Sherman, "Preface," in *Kazuyo Sejima + Ryue Nishizawa / SANAA* (Sydney: Sherman Contemporary Art Foundation, 2009).

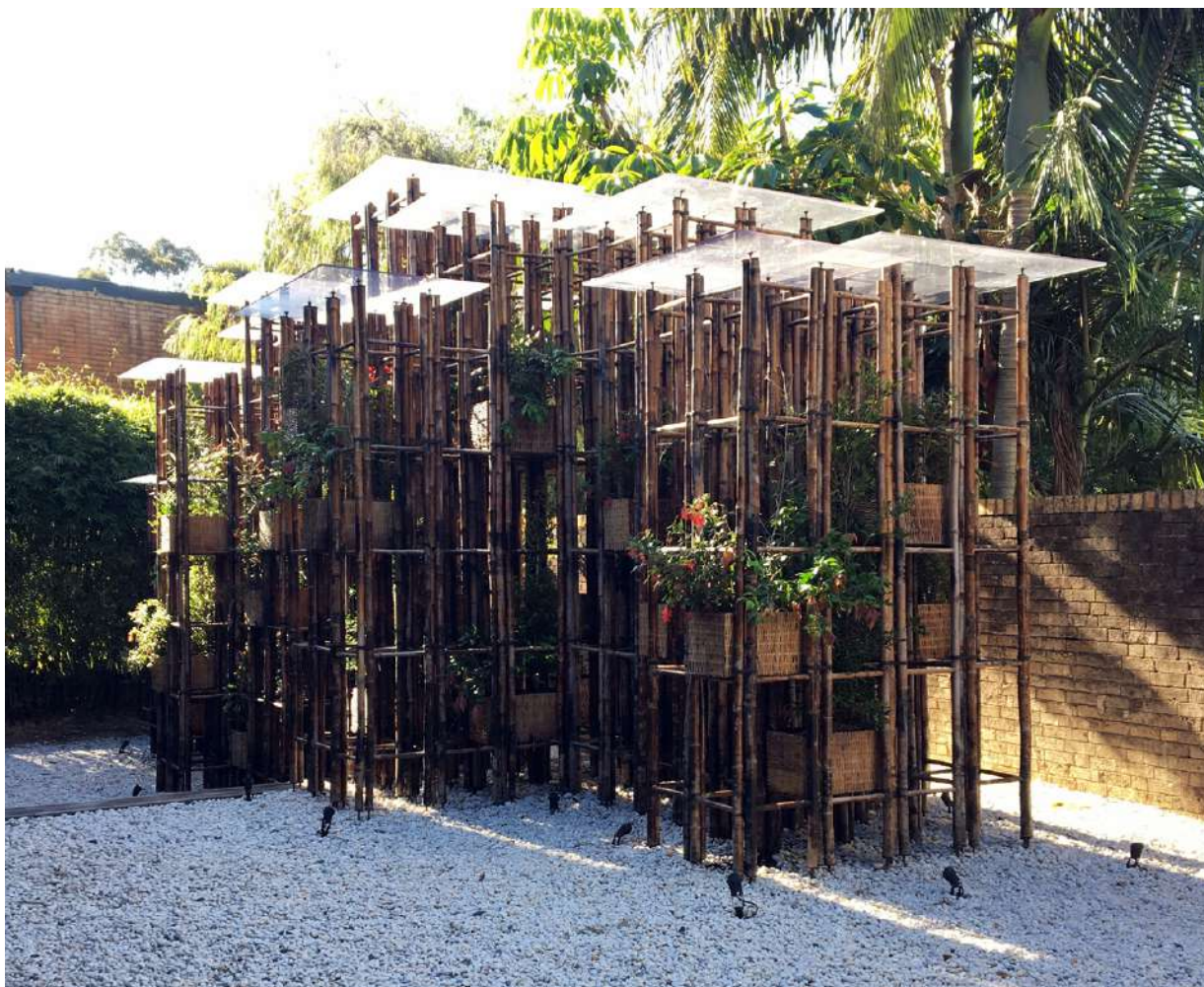

FIG. 10 Vo Trong Nghia Architects, 2016 *Fugitive Structures* project, *Green Ladder*, Sherman Contemporary Art Foundation (SCAF), Sydney. Source: Photograph by Ashley Paine, 2016

Australian-based designers. The 2015 structure *Sway* was by a multi-disciplinary collective based in Tel Aviv, Sack and Reicher + Muller with Eyal Zur, while *Green Ladder* in 2016 was designed by Vietnamese architect Vo Trong Nghia. Importantly, the works were commissioned following the same methodology as applied to other projects commissioned by the Gallery, blurring disciplinary distinctions between art and architecture. And, like SCAF's other projects, the pavilions were also complemented by a broad range of cultural events including talks, film screenings, performances, children's workshops, yoga and cooking classes. With this inclusive approach, Sherman stands apart as a pioneer in the exhibition and curation of architecture in Australia [Fig. 10].

Tellingly, SCAF's final exhibition in 2017, after a decade of some thirty-five major projects, once again featured an architect: Japan's Shigeru Ban. The exhibition also foreshadowed Sherman's next move—namely SCAF's transformation into the Sherman Centre for Culture and Ideas (SCCI) through which Sherman has redefined her cultural vision and curatorial ambitions. Launched in 2018, SCCI is a five-year proposition which sees Sherman concentrate her focus on fashion and architecture, in two annual events each spread over two weeks: a Fashion Hub in autumn,



FIG. 11 Shigeru Ban Architects, installation view from the 2017 exhibition, *The Inventive Work of Shigeru Ban*, Sherman Contemporary Art Foundation (SCAF), Sydney. Source: Photograph by Susan Holden, 2017

and an Architecture Hub in spring. What is most interesting, however, is that Sherman seems to have done away with exhibitions and pavilions to reimagine SCCI as a “unique, event-based cultural enterprise” and a “platform for the exchange of ideas.”<sup>28</sup> The Architecture Hubs in 2018 and 2019 included lectures, film screenings and book clubs, involving an international cast of architects, artists, curators, academics, writers, editors, journalists, activists and film makers.

Given Sherman’s previous efforts at the leading edge of architectural exhibition and curation in Australia, what should be made of SCCI’s shift in formats: from exhibition to event, and from architecture pavilions to Architecture Hub? Certainly, it follows a discursive turn in contemporary art practices, and the playing out of conceptual art’s legacy beyond its original disciplinary limits. But the change may also be in part due to the practical difficulties (not to mention the economic cost and material

28 Sherman Contemporary Art Foundation, “Press Release: SCCI Sherman Centre for Culture & Ideas: Dr Gene Sherman Launches Sherman Centre for Culture & Ideas,” <http://sherman-scaf.org.au/idea/scci-press-release/>.

consumption) associated with realizing pavilions.<sup>29</sup> While, as a temporary structure, the pavilion has often been an “event” in and of itself, it is also the case that in recent times, the pavilion has successfully provided the means for architecture to enter the gallery. Now that the pavilion has made the space and the audience for architectural exhibitions—not to mention a venue for a curated program of cultural activities—can the object now be abandoned, in favor of a public discourse on the culture of architecture that might be sustained in its own right? Was the pavilion only ever an architectural Trojan Horse?

Whatever the fate of the pavilions, their curation at SCAF through the *Fugitive Structures* program exposes the capacity of these 1:1 structures to become objects of curation, handled in the same way as other more conventional artistic artifacts and exhibitions. But with SCCI’s move to a program-based events platform, the question of architecture’s capacity to be curated is refocused on the curation of architectural ideas and discourse, and the expansion of curation itself to include what might otherwise be thought of as events management and programming. It also opens architecture’s curatorial activities to cultural discourses more generally, as well as a new role in shaping the cultural agenda for cities and communities.

## Curating architecture beyond the pavilion

What is striking about the contemporary pavilion is that it has appeared to escape theorization as a subject of curation. Yet, the form is clearly an instance of the expansion of curation as an activity of contemporary culture, and a vehicle through which the curation of architecture can occur. In this respect, the Australian pavilion programs present similar challenges to those in the visual arts, where curating is now considered a creative, even artistic, practice in its own right, and where the professional intent and artistic ambition associated with the activities of curating may blur or even be at odds. As shown here, pavilions are at once exhibited works and urban artefacts, immersive environments and spaces for events, temporary and permanent. What is curated is also multifaceted: it is the pavilion itself, an existing collection of sculpture, a cultural program, and a city image. In many of the Australian cases, the “curation” of the pavilion involves two or more of these operations at once.

The Australian pavilions thus open architecture up to a range of important questions regarding where the curatorial work takes place—what is being curated and by whom—and to what end? Such questions are important in understanding the changing place of architecture in contemporary

---

29 SCAF facilitated the relocation of the first of the *Fugitive Structures*, Andrew Burns’ 2013 *Crescent House*, which is now permanently housed at the Heide Museum of Modern Art, Melbourne. Similarly, the final project, Vo Trong Nghia Architects’ *Green Ladder* from 2016 was recently on display in Sydney’s Barangaroo.

culture, but also how new cultural practices are intersecting with practices of architectural design. Recognizing pavilions as subjects of curation allows the conversation to turn from one focused on understanding the pavilion as an architectural type, to questions such as: how does curation intersect with architectural and exhibition design, and when does design intersect with programming as a kind of curatorial practice?

At base, all three pavilion programs discussed here are “curated” simply by the fact of their seasonal construction. That is, to exhibit these works in an annual sequence implies a certain degree of curatorial control, even if that control is lightly administered as in the case of the NGV’s Architecture Commission. This curatorial work is being done by program patrons and administrators as often as by professional curators, through the selection of architects as well as through the designs themselves. It also intersects with the design work done by architects—in some cases, the design strategies can be considered distinctly curatorial, involving explicit reference to long-standing strategies of curation that intersect with exhibition scenography or practices of institutional critique that involve exhibition design to draw attention to the institutional frame, as in the case of the NGV’s *Garden Wall* project from 2017.

Beyond this, events programs are also curated, and through this activity the pavilions and their architects become part of a larger cultural agenda, as both subjects and producers. The design work in pavilions is, in turn, shaped by this situation: the performative aspects of culture have become a distinct register on which the design of pavilions can now operate—in addition to being an intensification, or distillation, of an architect’s oeuvre and/or their spatial, formal or material experiments in architecture, as they have often been characterized.

The larger cultural agendas that the Australian pavilions play into, are also multifaceted. The NGV aims to make a place for contemporary design in the art gallery, responding to recognized shifts in cultural practices and recent public policy and investment focused on the creative industries. The MPavilion and SCCI Architecture Hub both have an ambition to elevate the place of architecture and design in contemporary culture. While in the case of the SCCI Architecture Hub, this might now take the form of a virtual “pavilion of ideas,” for the MPavilion, it is still very much attached to the physical pavilions themselves, as festive objects during their summer season in Queen Victoria Park, and also in their afterlives as curios dispersed across the city which, if nothing else, secure a tangible legacy for the program. How this translates to better cities is a longer game and harder to judge.

Finally, if, as Balzer argues, the “curatorial impulse” is symptomatic of the alliance and proximity between capitalism and culture, in which curating is a complicit value-making enterprise, then there is a real question about what is being valued in the curatorial activities associated with

architecture, and what this means for the values of architecture as a cultural form or practice.<sup>30</sup> The Australian pavilions begin to tell us something of this. While their persistent and ubiquitous popularity as a mode of in-situ immersive exhibition tells us something of the current obsessions of the experience economy, it is in the particularities of their commissioning and realization that we can better understand what is at stake in architecture becoming a subject of new cultural practices such as curation: what is opened up and what is closed down.

**Susan Holden** is a Senior Lecturer in the School of Architecture at the University of Queensland and a Fellow of the Australian Institute of Architects. Her research explores architecture and urban design histories, architecture in cultural policy, and architecture's relationship to the visual arts. She has been published in a range of journals including *Journal of Architecture*, *Leonardo* and *AA Files*, and in the professional journal *Architecture Australia*. She is co-author of *Pavilion Propositions: Nine Points on an Architectural Phenomenon* (2018) and co-editor of *Valuing Architecture: Heritage and the Economics of Culture* (2020).

**Ashley Paine** is a Senior Lecturer in the School of Architecture at the University of Queensland. His research spans a range of subjects including the history of striped façades, the collection and reconstruction of architecture by museums, contemporary pavilions, and the preservation of Frank Lloyd Wright's built works. He has contributed to journals including *AA Files*, *Future Anterior*, and *Interstices*, and is a co-editor of the recent book, *Valuing Architecture: Heritage and the Economics of Culture* (Valiz, 2020). Paine is also a practicing architect, and co-founder of Brisbane-based practice, PHAB Architects.

---

30 Balzer, *Curationism: How Curating Took Over the Art World and Everything Else*, 9.



## References

- Balzer, David. *Curationism: How Curating Took Over the Art World and Everything Else*. Toronto: Coach House Books, 2014.
- Bois, Yve-Alain, Denis Hollier, Rosalind Krauss, and Jean-Louis Cohen. "A Conversation with Jean-Louis Cohen." *October* 89 (1999): 3-18.
- Chaplin, Sarah, and Alexandra Stara. "Introduction." In *Curating Architecture and the City*, edited by Sarah Chaplin and Alexandra Stara, xiii, 258 p. London; New York: Routledge, 2009.
- Cheng, Linda. "A landscape on an object': NGV's 2017 Architecture Commission opens." *ArchitectureAU*. Published electronically 15 December 2017. <https://architectureau.com/articles/a-landscape-on-an-object-ngvs-2017-architecture-commission-opens/>.
- . "Sean Godsell's MPavilion Unfurled." *ArchitectureAU*. Published electronically 6 October 2014. <https://architectureau.com/articles/mpavilion-opens/>.
- Clausen, Lisa. "A city's celebration of lives less ordinary, Naomi Milgrom and MPavilion." *Age*. <https://www.theage.com.au/national/victoria/a-citys-celebration-of-lives-less-ordinary-naomi-milgrom-and-mpavilion-20141203-11zh3s.html>.
- Davidge, Tania. "2018 MPavilion – Naomi Milgrom & Carme Pinós." Published electronically 13 February 2018. <http://archiparlour.org/2018-mpavilion-milgrom-pinos/>.
- Davidson, Cynthia, ed. *Log 20: Curating Architecture*, 2010.
- Dokulil, Heidi. "How the MPavilion is reshaping how we see the city." Published electronically 2 November 2016 <https://morespace.spacefurniture.com/latest-news/2016/10/31/how-the-mpavilion-is-reshaping-how-we-see-the-city>.
- Foundation, Sherman Contemporary Art. "Press Release: SCCI Sherman Centre for Culture & Ideas: Dr Gene Sherman Launches Sherman Centre for Culture & Ideas." <http://sherman-scaf.org.au/idea/scci-press-release/>.
- Holden, Susan. "Refiguring the Pavilion: Garden wWall, 2017 NGV Architecture Commission by Retallack Thompson and Other Architects." *Australian and New Zealand Art Journal* 18, No. 1 (2018): 154-57.
- . "'To be with architecture is all we ask': A cCritical gGenealogy of the Serpentine Pavilions." In *Quotation Quotation: Proceedings of the 34<sup>th</sup> Annual Conference of the Society of Architectural Historians of Australia and New Zealand*, edited by Gevork Hartoonian and John Ting, 255-66. Canberra: SAHANZ, 2017.
- Jodidio, Philip. "Interview with Julia Peyton-Jones and Hans Ulrich Obrist." In *Serpentine Gallery Pavilions*, edited by Philip Jodidio, 8-20. Köln: Taschen, 2011.
- Lavin, Sylvia. "Showing Work." *Log 20: Curating Architecture* (Fall 2010): 5-10.
- Luke, Ben. "Zaha Hadid's Lilas in Bloom." *Sotheby's Magazine*. Published electronically 12 September 2016. <http://www.sothebys.com/en/auctions/2016/beyond-limits-l16010.html>.
- Messner, Matthew. "Meet the finalists for the 2018 MoMA PS1 Young Architects Program." Published electronically 2 November, 2017. <https://archpaper.com/2017/11/finalists-ps1-yap/>
- Museum of Modern Art. "Young Architects Program (YAP)." <https://www.moma.org/calendar/groups/8>.
- "Naomi Milgrom Foundation." <http://mpavilion.org/about/naomi-milgrom-foundation/>.

National Gallery of Victoria. "2015 Summer Architecture Commission: John Wardle Architects."

<https://www.ngv.vic.gov.au/exhibition/john-wardle-architects/>.

———. "2016 NGV Architecture Commission: M@STUDIO Architects."

<https://www.ngv.vic.gov.au/exhibition/2016-ngv-architecture-commission/>.

———. "2018 NGV Architecture Commission Design Competition." <https://www.ngv.vic.gov.au/explore/collection/curatorial/design-architecture/2018-ngv-architecture-commission-design-competition/>.

———. "The Making of the Inaugural Summer Architecture Series: John Wardle Architects." <https://www.ngv.vic.gov.au/multimedia/the-making-of-the-inaugural-summer-architecture-series/>.

Obrist, Hans Ulrich. *A Brief History of Curating*. Zurich: JRP | Ringier; Dijon: Les Presses du réel, 2008.

Phillips, Andrea. "Pavilion Politics." *Log 20: Curating Architecture* (Fall 2010): 104-115.

Robinson, Joel, ed. *Open Arts Journal Issue 2: Pavilions*, 2013.

Rose, Julian, Hal Foster, Sylvia Lavin, Thomas Demand, Hilary Lloyd, Dorit Margreiter, Steven Holl, Philippe Rahm, and Hans Ulrich Obrist. "Trading Spaces: A Roundtable on Art and Architecture." *Artforum International* 51, no. 2 (2012): 201-211.

Sherman, Gene. "Preface." In *Kazuyo Sejima + Ryue Nishizawa / SANAA*, 9-11. Sydney: Sherman Contemporary Art Foundation, 2009.

CPCL

EUROPEAN JOURNAL OF  
CREATIVE PRACTICES  
IN CITIES AND LANDSCAPES

PRACTICES SECTION

# Artistic and Curatorial Power in Cities' Historic Spaces

Cristina Garzillo – ICLEI (Germany) – Contact: [cristina.garzillo@iclei.org](mailto:cristina.garzillo@iclei.org)

ABSTRACT

This article analyses and compares three neighbourhood/site projects in Athens, Salerno and Sunderland. Despite being on a small scale, they trigger vitality and revive spaces that invite creative uses. These examples have the aim to involve local residents and artists in creating public places and claim their right to oppose top-down impositions and globalization of cultural consumption returning decision-making power to the local communities. The ambition is that small artwork interventions can gradually propose meaningful transformations in a wider perspective.

KEYWORDS

*Creativity; Urban Revival; Curatorial Light; Performing Arts; Community Knowledge*

<https://doi.org/10.6092/issn.2612-0496/11739>

ISSN 2612-0496

Copyright © 2020 Cristina Garzillo



This article critically examines, through the analysis of public spaces, the transformation and redefinition of historic areas of 3 European cities during the last decade. Streets, squares, open places and public buildings have long been evoking social practices and traditions but also progress and modernity and are now becoming the driver for curatorial activities, borrowing their methods from artistic and museum practices. The decision to concentrate the analysis on three very different sites grew out of the need to examine urban renewal strategies and narratives, where ideas about artists and community building can take shape and be challenged. Each selected site encapsulates a new model of cultural space beyond the traditional categories of “protection” or “enhancement” and tries to respond to the questions on how are the new interventions created regarding a diversified contemporary cultural production.

The first site, the Church of *San Sebastiano del Monte dei Morti* (Mountain of the Dead), known as “Morticelli’s church”, is located in the historical centre of Salerno, in southwestern Italy. In the 80s, the church was completely abandoned as a consequence of earthquakes and lack of maintenance and became a synonymous of decay with few connections to the “lower” historical centre<sup>1</sup>.

The “San Sebastiano del Monte dei Morti Living Lab” (SSMOLL) is the process activated in 2018 by the Blam association group, the Municipality of Salerno, currently the owner of the building, and the Federico II University of Naples, aiming at reopening the former church, inserting it into a wider process of urban regeneration and social innovation applied to the “higher” historical centre.

The reopening of the former church in December 2018 indeed marked the start of a process of adaptive reuse of the historical asset through a collaborative process in which the community becomes the main interpreter of the new use value of the asset. Developed and generated over time inside the former church, the Creative Living Lab becomes the brain of a culture-led regeneration process, in which an abandoned ecclesiastical space becomes a place of community and incubator of creativity.

Since 2018 key ad-hoc performances are held in and outside the square adjoining the church with specific site installations as when curating an art show. A team of local artists has installed artworks and has worked together under the coordination of Flavia D’Aiello, a storyteller, puppet master and producer responding to an art call launched by the group association Blam. The living performances have built interactions and reflective relations among performers, a double-bass, video makers, ballerinas, illustrators and designers, as well as architects. Artists and assistants have installed the artworks on site, and the technicians set up the lighting and technical equipment exhibiting how culture enters into action while simultaneously proposing a connection to the topics of love and death in line with the symbolic meaning of the church. Contrary to the



FIG. 1 Church of San Sebastiano dei Morti—Blam Ludovica La Rocca

idea that curatorial activities are only interested in large budgetary works, candles lighting a temporary pottery exhibition in the square adjoining the church demonstrate the willingness to arrange a lot with very little, warning us on the theme of abandoned souls (so-called “anime pezzentelle”).

The idea of using artworks as a tool to activate participatory processes for regaining spaces in the collective urban imagination also exists in the creation of the “Museo Luminoso Diffuso”, a Luminous Museum spread all over the city, starting from the ex-church of the “Morticelli”. The aim of the project is to build a map of interventions able to bring light to abandoned and neglected places, maybe in popular quarters, traditionally seen as the “anomalous” localities of the city, and to examine how such images may change through the redefinition of urban space.



FIG. 2 Minerva Garden, Salerno—Luciano Mauro

In a similar fashion and without the fear of attributing new spatial experiences, the intervention “Lumina Minervae” in the Minerva Garden creates an unusual scenography and crafts a stage of lights, images, costumes and sounds to represent the history of the Salernitan Medical School.

The *Giardino della Minerva* (Minerva Garden), a 12th century terraced therapeutic botanical garden, is not exactly the first place that many visitors see when arriving in the city. It is indeed located in the highest part of the historic centre of Salerno. The Garden was part of the *Scuola Medica Salernitana* (Salernitan Medical School), considered to be the first medical educational institution in Europe and one of the forerunner universities. Salerno has been the home of the Salernitan Medical School since the 10th century. More than 300 plant species are grown here, arranged according to the ancient principles of humours (blood, phlegm, black bile and yellow bile) and linked to the fundamental elements (air, water, earth and fire) found in ancient medical literature. The temporary light intervention has the fundamental premise to emphasize the timelessness and secrecy of the site and mark the hidden alleys to reach it.

The second selected project<sup>2</sup> is a micro-experiment of urban revival consisting of a participatory light installation and artistic interventions aiming at “illuminating” the abandoned Pittaki Street in Athens, Greece. From 2012 until 2018, the project succeeded in establishing a profound dialogue with the local reality, addressing the concept of the place, the people involved and the power of curatorial light. It included creative groups in the placemaking process and engaged citizens to co-create a homely public

2 Stephania Xydia, “Illuminating Darkness: The Case Study of the Synoikia Pittaki Participatory Light Installation in Athens,” in *Our City? Countering Exclusion by Designing Cities for All*, ed. Minouche Besters (Rotterdam: STIPO & European Placemaking Network, 2019), 303–8.



FIG. 3 Pittaki Street, Athens—Beforelight

space attempting to offer an alternative to the dominant trajectory of urban decline. The project was initiated by Imagine the City<sup>3</sup>, an informal network of citizens focusing on urban regeneration, and was developed in partnership with Beforelight<sup>4</sup>, a creative group focusing on light design. The light installation was initially supported by the Municipality of Athens in terms of permits and technical support.

Pittaki street was selected as a fulcrum of Athenian urban decline. However, its historical links to antique dealers selling light fixtures and its proximity to the required electricity infrastructure, offered a fascinating opportunity to host the SynOikia<sup>5</sup> lighting concept on the troubled street. In autumn 2012 the resourceful, creative action of a group of inhabitants of Psyrri and wider central Athens donating old light fixtures was fundamental in order to finally bring this street out of dereliction and back to use. For a period of two months, an abandoned shop on Pittaki Street was converted into an open workshop offering opportunities for refurbishment of light fixtures. Over 150 chandeliers, lanterns, metal lamps, bell shades, glass bowls, colourful light fixtures were gathered, resulting in a colourful

3 <[www.imaginethecity.gr](http://www.imaginethecity.gr)> now established as Place Identity Clusters NGO <http://www.placeidentity.gr>, accessed 6 October 2020.

4 <[www.beforelight.gr](http://www.beforelight.gr)>, accessed 6 October 2020.

5 The project branding constituted a wordplay on the Greek word *synoikia* (quarter/district), separating its suffixes *syn* (co-) and *oikia* (home) to create a “CoHome” for Pittaki street.



FIG. 4 Pittaki Street, Athens—Nikos Libertas

bright canopy that covered Pittaki street. Parallel to the light installation, murals with pastel colours were painted along the walls of Pittaki street, and a series of community events enabled local people to reclaim their space. The small project of Pittaki Street proved extremely successful for its local impact, becoming a catalyst for a set of important changes in the neighbourhood.

The creation of public space for cultural fruition increased social and community participation and showed that the most effective and intelligent way to fight urban decay and disorders is not to build a security apparatus but to build places driving a sense of local pride and ownership of a “common” artwork. Soon, SynOikia Pittaki sparked the flourish of new businesses in empty stores and the return of inhabitants in the neighbourhood; it mobilized community activities such as murals painting, hosted



urban dinners and street parties and served as a source of inspiration for new urban interventions and artistic works in the city, offering a bright landmark of hope at times of severe socioeconomic crisis.

The third selected site in Sunderland, UK is still at an embryonic stage.

Sunderland's 'Historic High Streets' is a Heritage Action Zone (HAZ).<sup>6</sup> HAZs are a 2017 initiative by Historic England, that aims to use heritage to unlock problems of deprivation and dilapidation, with a particular focus on high streets. This particular HAZ area reflects the early urban history of Sunderland, a post-industrial city in the north-east of England. It is exploring how to develop a viable future for the area through restoration of the historic environment, in a neighbourhood ranked amongst the 10% most deprived neighbourhoods in England. The project is managed by a partnership including Sunderland City Council (SCC), Historic England (HE), Sunderland Heritage Forum, the Churches Conservation Trust, Tyne and Wear Building Preservation Trust (TWBPT) and Sunderland Culture (SC). They are collaborating on researching, repairing and regenerating historic buildings and developing community projects encouraging local people to get involved.

The TWBPT is currently restoring three buildings in the HAZ: 170-175 High Street West. They were built as merchant houses in the 1790s and only a few years after they were built the houses were turned into shops and offices as the street they are on became the "high street", and the commercial heart of the town. The changes in commerce and city structure have meant a loss of function and use for the buildings, which led to vacancy and deterioration<sup>7</sup>. After being left vacant and in disrepair for at least the past two decades, the buildings were finally obtained by Sunderland City Council and gifted to the TWBPT in 2018. The renovation is undertaken in collaboration with various other local stakeholders, to develop new use, create mutual benefit in doing the buildings up, and providing accessible space for a variety of users.

To support the restoration, events and activities are being organized in collaboration with (future) tenant(s) and users, local organizations, SMEs, artists, neighbourhood organizations, schools, and local government. These vary from heritage informed events such as lectures and exhibitions on the history of the buildings and the area, to a community mural and pop-up coffee shop<sup>8</sup>, an exhibition and workshop on "Rebel Women

---

6 HAZ is a policy tool, applied in nearly 90 local authorities across England. It aims at having restoration and reuse contribute to dealing with poverty, austerity, and socio-economic inequalities in public space.

7 Martin Hulse, Loes Veldpaus, and OpenHeritage, "Highstreet West, Sunderland Great Britain | OpenHeritage" (2020), <https://openheritage.eu/heritage-labs/high-street-sunderland/>, accessed 6 October 2020.

8 Loes Veldpaus, Sally Watson, and Amelia Turner, "Heritage Open Day - 170-175 High Street West Collaborative Lab - Sunderland" (2019), [https://hswsunderland.openheritage.eu/processes/events](https://hswsunderland.openheritage.eu/processes/events;); <https://youtu.be/RmyFtVz4ZfQ>, accessed 6 October 2020.



FIG. 4 Marion Phillips and Kenickie by Kathryn Robertson

of Sunderland” developed with Sunderland Culture<sup>9</sup> and Sunderland University<sup>10</sup>, and various music performances, podcast recordings, and arts and crafts workshops organized by Pop Recs and partners (2020)<sup>11</sup>.

Pop Recs, a Community Interest Company (CIC)<sup>12</sup>, is involved from the beginning as a local partner and future user of part of the buildings after restoration, and have the rights to temporary use during renovation. The involvement of Pop Recs helps to bring life and creativity, raise the profile of the project, and show that the restoration project is about more than restoring material. Their involvement through temporary use helps test the building and explore how that temporary use may develop into a permanent fixture.

The “Rebel Women of Sunderland” exhibition and events were led by Sunderland Culture, whose mission is to improve life for everyone in Sunderland through culture, set up to support activities to performing arts in Sunderland. They commissioned two young women creatives—illustrator Kathryn Robertson and writer Jessica Andrews—to collaborate on the project, producing illustrations and stories to tell the tales of historic and contemporary women with importance to Sunderland.

On the one hand, the mural by Robertson lining the walls creates an open dialogue with the past, by emphasizing historical fragments and having people join in the drawing. On the other hand, a new generation of women

9 Sunderland Culture et al., “Rebel Women of Sunderland,” Sunderland Culture (2019), <https://sunderlandculture.org.uk/rebelwomen/>, accessed 6 October 2020.

10 Dr. Sarah Hellawell, “Dr Marion Phillips: Sunderland’s First Female MP (1929-1931),” Women’s History Network (August 14, 2019), <https://womenshistorynetwork.org/dr-marion-phillips-sunderlands-first-female-mp-1929-1931-by-dr-sarah-hellawell/>, accessed 6 October 2020.

11 Record Shop, a Coffee Shop, an Art Space and Live Music Venue Ran by Frankie & The Heartstrings” (2020), <https://www.facebook.com/poprecsltd/>; <https://www.poprecs.co.uk/>, accessed 6 October 2020.

12 A CIC is a special type of limited company, which exists to benefit the community rather than private shareholders.

could create a new interpretation of the city which would seek innovative ways of understanding culture where the historical background is added to other and more recent creative knowledge. Crowd-sourced through social media, this project has shown to have a rare aptitude for mobilizing the local community and the media, drawing attention to the “People Power”, as Laura Brewis, Creative Producer at Sunderland Culture said and convert unknown stories into achievements of women from the city from a historical and current perspective.

It seems possible to state that there are significant similarities between the three situations analyzed. They are isolated projects on a small scale, however enjoying vitality and reviving spaces that invite creative uses. These examples sought to involve local residents and artists in creating public place and claim their right to oppose top-down impositions and globalization of events and cultural consumption returning decision-making power to the local communities. It remains to be seen if the neighbourhoods/sites redesigned by artworks and community engagement have not only the power to provoke and reconsider but also believe that transforming the state of things is possible, starting from small interventions and gradually proposing meaningful alternatives to anticipate the future.

**Cristina Garzillo** Employed with ICLEI since 2005. Having almost 20 years of experience working in and for local governments, Cristina is recognised for her work as expert in local sustainability processes, integrated management and governance as well as author of numerous publications in the field of local sustainability, cultural heritage and knowledge brokerage. Cristina is an external evaluator for the URBACT III programme and an expert for the European Commission and the Committee of the Regions. She can also draw on a wealth of academic experience gained from previous role as contract professor at the University of Parma.



EUROPEAN JOURNAL OF  
CREATIVE PRACTICES  
IN CITIES AND LANDSCAPES

#### MISCELLANEA

# On the Practical and Theoretical Possibility of Exploiting Science Fiction for Urban Planning

Peter Klimczak – Brandenburg University of Technology (Germany) – Contact: peter.klimczak@gmail.com

#### ABSTRACT

In recent years, cities and districts, such as Songdo City in South Korea, King Abdullah Economic City in Saudi Arabia, or Singapore, have been planned, built and rebuilt in adherence to the guiding principle of a "Smart City". Some science fiction scenarios are in parts reminiscent of control systems already implemented in these places. Science fiction therefore offers approaches to urban development policy, for example to visualise the possible effects of uncontrolled technologization of the living environment. But is such a use of science fiction even possible? After all, one of the most essential distinctions in literary and media studies is the differentiation between factual and fictional discourse. For most scholars, the decisive distinguishing feature is on the level of form. Using set theory, I intend to differentiate between them on the level of content. This makes it possible to show the hybrid status of science fiction between fictionality and factuality. It is precisely this seemingly contradictory in-between that makes this genre so attractive and highlights its potential for reality. For example, for urban planning.

#### KEYWORDS

*Urban Planning; Smart Cities; Science Fiction; Media Theory; Set Theory*

PEER REVIEWED

<https://doi.org/10.6092/issn.2612-0496/10860>

ISSN 2612-0496

Copyright © 2020 Peter Klimczak



## Learning from science fiction cities. A project

On behalf of the “Federal Institute for Research on Building, Urban Affairs and Spatial Development” (BBSR), the project “Learning from Science Fiction Cities: Scenarios for Urban Planning” was carried out at the Brandenburg University of Technology (Chairs Urban Management and Applied Media Studies).<sup>1</sup> The aim of the project was to investigate whether insights into the future of cities can be inferred from futuristic city designs. Films, comics, novels and computer games in which cities serve as a central plot element were analysed. The focus was on the hermeneutic elaboration of recurring themes. The relevance of each theme for planning discourses was then examined.

It became apparent over the course of the investigations that technologization of the living environment, which is the subject of many works, is perhaps the most promising theme. The development of machines for various areas of life has an indirect, enormous impact on the organisation of urban space. Examples of this are the films *I, Robot* (2004), in which humanoid robots are used as workers and helpers in all areas of life and the film *Her* (2013), which depicts the loneliness of urban dwellers despite utopian infrastructure conditions. A main focus is on the opportunities and emotional risks of a relationship with (disembodied) artificial intelligences. In addition to utopian visions for the future in the broadest sense, there are dystopian imaginings of the future. Many works feature, for example, the recurring scenario of total technical surveillance of the population and the resulting spatial segregation of population groups (e.g. in the comic series “Hard Boiled” (1990-1992)).<sup>2</sup>

Examples from (East) Asia show that technological developments have to be taken into account in urban planning. In recent years, cities and districts have been planned, built and rebuilt in adherence to the guiding principle of a “Smart City,”<sup>3</sup> such as Songdo City in South Korea,<sup>4</sup> King Abdullah Economic City in Saudi Arabia,<sup>5</sup> or Singapore.<sup>6</sup> Some science fiction scenarios are in parts reminiscent of control systems already implemented in these places. These include central data management by

---

1 See regarding the documentation of the project I was involved in as a consultant: Carolin Pätsch et al., “Von Science-Fiction-Städten lernen: Szenarien für die Stadtplanung” (Bonn: BBSR, 2015); Moritz Maikämper and Carolin Pätsch, “Exploration and Imagination of City Futures in Science-Fiction,” in *Proceedings of the 20th International Conference on Urban Planning, Regional Development and Information Society*, ed. Manfred Schrenk et al., 2015, 295–300.

2 See concerning *Her* the contribution of Denis Newiak in Anke Steinborn and Denis Newiak, eds., *Urbane Zukünfte im Science-Fiction-Film: Was wir vom Kino für die Stadt von morgen lernen können* (Berlin: Springer, 2020), <https://doi.org/10.1007/978-3-662-61037-4>.

3 Andrew Karvonen, Federico Cugurullo, and Federico Caprotti, eds., *Inside Smart Cities: Place, Politics and Urban Innovation* (New York: Routledge, 2018), <https://doi.org/10.4324/9781351166201>.

4 [https://en.wikipedia.org/wiki/Songdo\\_International\\_Business\\_District](https://en.wikipedia.org/wiki/Songdo_International_Business_District)), accessed September 23, 2020.

5 <https://www.kaec.net/>, accessed September 18, 2020.

6 <https://www.smartnation.sg/>, accessed September 23, 2020.

a private company as well as the utter dependence of urban functionality on the technology used. Science fiction therefore offers approaches to urban development policy, for example to visualise the possible effects of uncontrolled technologization of the living environment.

## The hybrid status of science fiction. A distinction

One of the most essential distinctions in literary and media studies is the differentiation between factual and fictional discourse. For most scholars, the decisive distinguishing feature is on the level of form.<sup>7</sup> By contrast, the distinction between “real” and “not real,” the distinction on the level of content is for them and most literary, film and media scholars secondary. Consequently, the non-literary narration of imagined events is treated as a special case in factual discourse. Traditionally, this has been referred to as fictitious discourse; today, one might sooner use the term fake.

This kind of distinction, however, is accompanied by a crucial problem: a clear classification is not possible, as I would like to show by two examples. In the long history of the Nobel Prize for Literature, for example, there have been several awards to non-fictional works. For instance, the second Nobel Prize for Literature was awarded in 1902 to Theodor Mommsen with special reference to his monumental work, *History of Rome*. The commendation called him “the greatest living master of the art of historical writing.”<sup>8</sup> Yet the literary Nobel has since also been awarded to Bertrand Russell (in 1950) “in recognition of his varied and significant writings in which he champions humanitarian ideals and freedom of thought”<sup>9</sup> and to Winston Churchill (in 1953) “for his mastery of historical and biographical description as well as for brilliant oratory in defending exalted human values.”<sup>10</sup> So there are certainly factual texts that meet the criteria for literature in terms of form. They would have to be classified as fictional works according to the scheme referred to above. On the other hand, there are entire genres that present fiction in the same way as facts, e.g. so-called mockumentaries. A mockumentary is a type of film or television show depicting fictional events but presented as a documentary. Maybe the distinction on the level of form isn’t adequate, after all.<sup>11</sup>

---

7 See concerning the state of the art distinction: Matías Martínez and Michael Scheffel, *Einführung in die Erzähltheorie* (München: Beck, 2020), 12, <https://doi.org/10.17104/9783406742910>.

8 <https://www.nobelprize.org/prizes/literature/1902/summary/>, accessed September 23, 2020.

9 <https://www.nobelprize.org/prizes/literature/1950/summary/>, accessed September 23, 2020.

10 <https://www.nobelprize.org/prizes/literature/1953/summary/>, accessed September 23, 2020.

11 For further information: Craig Hight, “Mockumentary: A Call to Play,” in *Rethinking Documentary: New Perspectives and Practices*, ed. Austin Thomas and de Jong Wilma (Berkshire: Open University Press, 2008), 204–16.

For the first media theorist of the Western world, Aristotle, the decisive criterion is *not* the linguistic form, but the truth or falsehood of what has been said.<sup>12</sup> I intend to differentiate between factuality, fictionality and fake not only starting from the level of content but based *solely* on the level of content. Nevertheless, the intention is not to pick up from where Aristotle leaves off. That is to say: my premise is not the difference between being and possibility, between “what actually happens” and “what could happen.” Rather, the point of departure shall be the (to this day) prevailing idea of content as a “represented world” in literary, film and media studies discourse. An interesting approach in this respect is formulated by Michael Titzmann, who sees the represented world as being described by a set of ordered propositions.<sup>13</sup> What Titzmann is suggesting is nothing less than the set theory modelling of represented worlds, which, however, neither he nor anyone else has carried out.

Recently I showed<sup>14</sup> that represented worlds (“ $R_x$ ”) can be modelled as sets (“ $\{\}$ ”) whose elements are ordered pairs (“ $(x, y)$ ”) that symbolise the statements that apply to the represented world. For instance, *Houston, We Have a Problem!* is a 2016 internationally co-produced mockumentary film that claims that Yugoslavia developed a space program in the early 1960s, which was then sold to the John F. Kennedy administration for \$2.5 billion. In the represented world of the film, the two propositions “Yugoslavia developed a space program in the early 1960s” (“ $D$ ”) and “Yugoslavia sold its space program to the USA for 2.5 billion dollars” (“ $S$ ”) are each given the truth value “true” (“1”) and both statements are noted down in the form of an ordered pair:

$$R_H = \{(D, 1), (S, 1)\}.$$

Or generally:<sup>15</sup>

$$R_x = \{(x,y) \mid (x,y) \text{ is a statement of the represented world of text } X\}.$$
<sup>16</sup>

Since such modelling is possible not only for represented worlds (“ $R_x$ ”) but also—in application contexts—for the “real” world (“ $W$ ”),

12 Aristotle, *Poetics* (Oxford: Oxford University Press, 2013), 28–29 (=1451b), <https://doi.org/10.1093/oseo/instance.00258601>.

13 Michael Titzmann, “Semiotische Aspekte der Literaturwissenschaft,” in *Semiotik. Ein Handbuch zu den zeichentheoretischen Grundlagen von Natur und Kultur* 3, ed. Roland Posner, Klaus Robering, and Thomas A. Sebeok (Berlin: De Gruyter, 2003), 3028–3103, especially 3071.

14 See Peter Klimczak, “Fremde Welten—Eigene Welten. Zur Kategorisierenden Rolle von Abweichungen für Fiktionalität,” *Medienkomparatistik* 2 (2020), 113–137.

15 In order to remain as comprehensible as possible, the mathematical representation has been simplified. For a detailed description see Klimczak 2020.

16 Read: “The represented world of text  $X$  [ $=R_x$ ] is the set of all statements [ $=\{(x,y)\}$ ] for which applies:  $(x,y)$  is a statement of the represented world of text  $X$ .”



$$W = \{(x,y) \mid (x,y) \text{ is a statement of the real world}\},^{17/18}$$

one can determine through simple comparison of the elements of the sets in question whether there is a subset relation between the represented world set and the real world set, thus whether the set that symbolizes the represented world is a subset of the set that symbolizes the real world:

$$R_x \subset W,^{19}$$

$$R_x \not\subset W.^{20}$$

Regarding the example above, it must be stated that the represented world of *Houston, We Have a Problem!* is not a subset of the set symbolizing the real world,

$$R_H \not\subset W,$$

since neither the statement "It is true that Yugoslavia developed a space program in the early 1960s" ("(D, 1)") nor the statement "It is true that Yugoslavia sold its space program to the USA for 2.5 billion dollars" ("(S, 1)") are elements of the set symbolizing the real world. On the contrary, it can be assumed that both the statement "It is false that Yugoslavia developed a space program in the early 1960s" ("(D, 0)") and the statement "It is false that Yugoslavia sold its space program to the USA for 2.5 billion dollars" ("(S, 0)") are elements of the set that symbolizes the real world:

$$W = \{(D, 0), (S, 0), \dots\}.^{21}$$

However, the determination of a subset relation is possible not only in terms of the sets that describe the represented and the real worlds, i.e. the statements within the represented and real worlds, but also with respect to the mere proposition of the represented and real worlds.<sup>22</sup> For this purpose, the domains of the sets that symbolize the represented and the real worlds must be determined,

$$\text{Dom } R_x = \{x \mid \text{is a proposition of the represented world of text } X\},^{23}$$

17 Read: "The real world [=W] is the set of all statements [= (x,y)] for which applies: (x,y) is a statement of the real world."

18 At this point, the question arises as to what is meant by statements of the real world. I plead to accept as statements of the real world all statements of the real world which are sufficiently proven. Whether a statement can be considered sufficiently proven depends on whether the derivation of this statement meets certain criteria: consistency, reasoning, method, citation, depth of research, authority and so on. See Klimczak 2020 for a detailed description and discussion.

19 Read: "The represented world of text X is a subset of the real world" or more detailed "The set containing the statements of the represented world of text X is a subset of the set containing the statements of the real world."

20 Read: "The represented world of text X is *not* a subset of the real world" or more detailed "The set containing the statements of the represented world of text X is *not* a subset of the set containing the statements of the real world."

21 It may also be assumed that the set that symbolizes the real world has other elements (statements). This circumstance is explained by "...".

22 As has been seen in the above exposition, "statement" means a "proposition" to which a truth value (true, false) is assigned. For example: "It is false that Yugoslavia developed a space program in the early 60s." A proposition, on the other hand, is a mere description of a matter without determining whether the described matter is true or false.

23 Read: "The domain of the represented world of text X [=Dom R<sub>x</sub>] is the set of all propositions [=x] for which applies: x is a proposition of the represented world of text X."

$$\text{Dom } W = \{x \mid x \text{ is a proposition of the real world}\},^{24}$$

and the subset relation between their domains verified:

$$\text{Dom } R_x \subset \text{Dom } W,^{25}$$

$$\text{Dom } R_x \not\subset \text{Dom } W.^{26}$$

Contrary to the statements, with regard to the propositions of the represented world of *Houston, We Have a Problem!* there is a subset relationship to the set that symbolizes the real world:

$$\text{Dom } R_H \subset \text{Dom } W.$$

Both the proposition "Yugoslavia developed a space program at the beginning of the 1960s" ("D") and the proposition "Yugoslavia sold its space program to the USA for 2.5 billion dollars" ("S") are elements of the sets that symbolize the represented world and the real world:

$$\text{Dom } R_H = \{D, S\},$$

$$\text{Dom } W = \{D, S, \dots\}.$$

Based on such a double determination of the subset relation, that is, both in terms of the sets symbolizing the represented and the real world, as well as the domains of these sets, the represented world can be classified as factual, fictional or fake:

$$(\text{Dom } R_x \subset \text{Dom } W) \wedge (R_x \subset W) \leftrightarrow R_x \text{ is factual,}$$

$$(\text{Dom } R_x \subset \text{Dom } W) \wedge (R_x \not\subset W) \leftrightarrow R_x \text{ is a fake,}$$

$$(\text{Dom } R_x \not\subset \text{Dom } W) \wedge (R_x \not\subset W) \leftrightarrow R_x \text{ is fictional.}$$

In other words: (1) A represented world is thus factual if and only if it contains no proposition that does not occur in the set that symbolizes the real world (so that a subset relation exists between the domains of the represented world set and the real world set) and at the same time all truth values of their propositions match truth values of the set that symbolizes the real world (so that a subset relation exists between the domains of the represented world set and the real world set); (2) A represented world is fake if and only if it contains no proposition (as in the case of factual represented worlds) that does not occur in the set that symbolizes the real world, but at the same time (as opposed to the factual represented world), at least in regard to one proposition, a different truth value exists than in the set that symbolizes the real world (in this case a statement about the represented world no longer agrees with the corresponding statement

---

24 Read: "The domain of the real world [=W] is the set of all propositions [=x] for which applies: x is a proposition of the real world."

25 Read: "The domain of the represented world of text X is a subset of the domain of the real world" or more detailed "The set containing the propositions of the represented world of text X is a subset of the set containing the propositions of the real world."

26 Read: "The domain of the represented world of text X is *not* a subset of the domain of the real world" or more detailed "The set containing the propositions of the represented world of text X is *not* a subset of the set containing the propositions of the real world."

about the real world, so that there is no subset relation between the represented world set and the real world set); (3) A represented world is fictional if and only if it contains at least one proposition that does not occur in the set that symbolizes the real world (so that there is no subset relation between the domains of the represented world set and the real world set). What truth value is attributed to this proposition is irrelevant, as a subset relation between the represented world set and the real world set is thus automatically impossible.

With this distinction it is actually no problem to classify the oeuvres of Mommsen, Russell and Churchill not as fictional but factual, and mockumentaries—as shown by the example of *Houston, We Have a Problem!*—not as factual but as fake. But does this also solve the problem for science fiction films? Each film is a mere product of its respective time of origin. This also applies to the represented worlds, which are set in the earthly future or on planets far away from the earth. And because all these films are products of a very specific time and a very specific culture, it is also valid that their foreign, represented worlds are examined for analogies to the real world of their respective time of origin.<sup>27</sup> The foreign, represented worlds can then be read not only literally, but also figuratively. The degree of explicitness as well as concreteness of the respective references may vary from film to film, but in most cases the analogies to be found to the respective extra-filmic conditions will suffice to neutralize both the temporal and spatial difference:<sup>28</sup> The foreign, represented world represents only a mirror image, a distorted image or a desired image of the real extra-filmic world. This leads to the question whether a clear classification with the previously presented model is possible at all. Of course it is, but this depends on the degree of abstraction.

If, for example, one does not abstract from the fact that the represented worlds are situated in the future in relation to the time when the films were made, there are necessarily no correspondences in the real world for all statements (or more precisely: propositions) of the film: everything that happens in the future is necessarily contingent. Accordingly, all the statements in science fiction films (like the existence of sophisticated artificial intelligence) are not elements of the set that represent the real world. And since this applies not only to the statements, but also, and especially, to the proposition, the represented world is to be classified as fictional according to the set-theoretical definitions of fictionality, factuality and fake.

---

27 See concerning the relationship between the represented and the real world: Peter Klimczak et al., *Filmsemiotik. Eine Einführung in die Analyse audiovisueller Formate* (Marburg: Schüren, 2017), 225–29.

28 See concerning the process of neutralisation and substitution: François Rastier, "Systématique des isotopies," in *Essais de sémiotique poétique*, ed. Algirdas Julius Greimas (Paris: Larousse, 1972), 80–105. See, for an example in the context of the set-theoretical modeling presented here: Klimczak 2020.

But if one neglects the level of temporal situation, the level of the represented characters and any concrete form in the individual film and limits the perspective, specific differences can't be detected between the represented and the real world. In other words: The represented worlds are factual due to the fact that they contain no proposition that does not occur in the set that symbolizes the real world (so that a subset relation exists between the domains of the represented world set and the real world set) and at the same time all truth values of their propositions match truth values of the real world set (so that a subset relation exists between the domains of the represented world set and the real world set).

But it is precisely this seemingly contradictory in-between, this hybrid status of science fiction between fictionality and factuality, that makes this genre so attractive and highlights its potential for reality. For example, for urban planning. Science fiction films potentially equip city planners and future scientists with a rich repertoire of possible solutions for the known and unknown urban questions and gives them the freedom to think "outside the box."

**Peter Klimczak** (Priv.-Doz. Dr. phil. et Dr. rer. nat. habil.) is Deputy Head of the Department of Applied Media Studies at the Brandenburg University of Technology. In addition, he has been a guest professor at the University of Bologna, University College Dublin, the University of Lodz and the University of Wrocław. His research interests are formal-logical/mathematical modeling of cultural-scientific theories and concepts, digitization in media and cultural studies, and media, cultural and film semiotics. Together with Samuel Schilling and Christer Petersen, he has recently published "Maschinen der Kommunikation" [Machines of Communications] (Springer 2019) and "Soziale Medien" [Social Media] (Springer 2020).

## References

- Aristotle. *Poetics*. Oxford: Oxford University Press, 2013. <https://doi.org/10.1093/oseo/instance.00258601>
- Hight, Craig. "Mockumentary: A Call to Play." In *Rethinking Documentary: New Perspectives and Practices*, edited by Austin Thomas and de Jong Wilma. Berkshire: Open University Press, 2008, 204-216.
- Karvonen, Andrew, Federico Cugurullo, and Federico Caprotti, eds. *Inside Smart Cities: Place, Politics and Urban Innovation*. New York: Routledge, 2018. <https://doi.org/10.4324/9781351166201>
- Klimczak, Peter. "Fremde Welten - Eigene Welten. Zur kategorisierenden Rolle von Abweichungen für Fiktionalität." *Medienkomparatistik 2* (2020), 113-137.
- Klimczak, Peter, Dennis Gräf, Stephanie Großmann, Hans Krahl and Marietheres Wagner. *Filmsemiotik. Eine Einführung in die Analyse audiovisueller Formate*. Marburg: Schüren, 2017.
- Martínez, Matías, and Michael Scheffel. *Einführung in die Erzähltheorie*. München: Beck, 2020. <https://doi.org/10.17104/9783406742910>
- Pätsch, Carolin, and Moritz Maikämper. "Exploration and Imagination of City Futures in Science-Fiction." In *Proceedings of the 20th International Conference on Urban Planning, Regional Development and Information Society*, edited by Manfred Schrenk, Clemens Beyer, Pietro Elisei, Vasily Popovich, and Peter Zeile, 2015.
- Pätsch, Carolin, Moritz Maikämper, Steffen Krämer, Belinda Rukschcio, and Bodo Rott. *Von Science-Fiction-Städten Lernen : Szenarien für die Stadtplanung*. Bonn: BBSR, 2015.
- Rastier, François. "Systématique des isotopies." In *Essais de sémiotique poétique*, edited by Algirdas Julius Greimas. Paris: Larousse, 1972, 80–105.
- Steinborn, Anke, and Denis Newiak, eds. *Urbane Zukünfte im Science-Fiction-Film: Was wir vom Kino für die Stadt von morgen lernen können*. Berlin: Springer, 2020. <https://doi.org/10.1007/978-3-662-61037-4>
- Titzmann, Michael. "Semiotische Aspekte der Literaturwissenschaft." In *Semiotik. Ein Handbuch zu den zeichentheoretischen Grundlagen von Natur und Kultur 3*, edited by Roland Posner, Klaus Robering, and Thomas A. Sebeok. Berlin: De Gruyter, 2003, 3028-3103.

## OPINION

# Between Decay and Decorum: Photographers' Awareness of the Urban Scene

Michele Smargiassi – Sisf – Società Italiana di Studi di Fotografia (Italy) – Contact: [m.smargiassi@repubblica.it](mailto:m.smargiassi@repubblica.it)

## ABSTRACT

The development of the metropolis and the birth of photography are contemporary phenomena, but their relationship is not unidirectional; photography has not only represented the city, it has also suggested its best form and conditioned its ideology. In the dialectical opposition between decay and decorum, a powerful instrument of urban-social despotism, the photographers of the city have sometimes sided with the powers in place disciplining spaces and at other times with the critics of urbanism and its failures: but is a clear opposition between the two attitudes really possible? To what extent can showing the decay can incite the restoration of decorum, and how? Has the visual denouncement of urban social marginalization contributed to urge interventions of repression rather than rebalancing his situation?

By quickly retracing the history of urban photography from the 19th century to the present day, this text tries to identify its ambiguities and highlight some attempts at apprehending an image of the urban environment that includes a redemption in terms of inclusion, justice, and citizenship.

## KEYWORDS

*Decay; Decorum; Metropolis; Photography; Marginalization*

<https://doi.org/10.6092/issn.2612-0496/11884>

ISSN 2612-0496

Copyright © 2020 Michele Smargiassi



FIG. 1 Ambrogio Lorenzetti, *The Allegory of Good and Bad Government* (1338-1339). Siena, Palazzo Pubblico, Image Credit: Wikimedia Commons.

*SICINIUS* - *What is the city but the people?*

*CITIZENS* - *True, the people are the city.*

[William Shakespeare, *Coriolanus*]

Many different cities overlap that physical, blunt and edgy thing that we call a city: the built city, the one that is lived in, the one that is simply looked at. The city of spaces and the city of bodies. At the end of the day, what we call a city is an image that is formed before our mental eyes, layer after layer, as if passing through multiple sheets of translucent drawing paper.

Long before 1927 when the German director Walter Ruttmann crowned Berlin as the theophany of the metropolis in his cinematic homage



*Symphony of a Metropolis*, the contemporary urban experience had already become powerfully, almost exclusively visual. The very concept of metropolis asserted itself in the 19th century as a colossal show in which citizens are both the actors, or rather a jumbled mass of bit players, and the individual spectators. The *flâneur*, the hero of the metropolis, the animal that is most comfortable in that jungle, of which he is both the consumer and the defenceless victim, is in fact a hypertrophic eye that walks with hands in pocket, like the visitor at an exhibition in a famous drawing by Herbert Bayer.<sup>1</sup>

Sight is therefore the sense that the metropolitan man is required to develop to the highest degree if he wants to have a chance at social survival. This is why the modern city was the photographed city, to the point that these two expressions are practically synonymous. We can even say “this is a city” when looking at Paul Citroen’s chaotic photomontages, whose spaces—if they were real—would be impossible to live in.

It is no coincidence that the metropolis and photography are contemporaries. Just as it is no coincidence that among the many inventors of photography the only one to achieve institutional recognition was Daguerre, who made his fortune with the Diorama, an illusionist show, a variant of the Panorama that in the 19th century was a very powerful albeit underestimated medium for consumption of the urban image as a visual commodity, as a show.<sup>2</sup>

It can safely be said that the metropolis could not have been what it was in the two long centuries of modernity without photography. Moreover, it can also be said that the birth of the latter required the existence of the former: the scientific, optical and chemical knowledge necessary to invent photography had already been available for two or three centuries. The right fire starter was missing to inflame the “burning desire” (Geoffrey Batchen) for mechanical reproduction of reality: there had to be something to look at. Something that was not only worth looking at, but that existed above all to be looked at. An object-simulacrum, therefore a commodity. But an absolute commodity, containing all the commodities. That total commodity was the metropolis.<sup>3</sup>

As a narrator of the modern city, photography has not simply lent itself passively to the game of spectacularisation. It was not just a medium. It did not merely offer the most efficient channel for mass distribution, acting as persuasive propaganda for urban ideology. Rather it established the discursive conditions of urban transformation, anticipated its evolution and in some cases dictated its solutions.

---

1 <https://i.pinimg.com/originals/8e/23/e3/8e23e3ba2ffcb57ccd74c36bb3a6835c.jpg>

2 Walter Benjamin, “Das Kunstwerk Im Zeitalter Seiner Technischen Reproduzierbarkeit.” In *Schriften* (Frankfurt am Main: Suhrkamp Verlag, 1955).

3 Geoffrey Batchen, *Burning with Desire. The Conception of Photography* (Cambridge, Mass. - London: MIT Press, 1997).

Forty years ago at the University of Bologna I went to visit a luminary of space history, Lucio Gambi, to tell him that there were already too many graduates in letters, so I had thought of graduating in postcards. He accepted my joke, and my thesis project, without blinking. I wanted to try to demonstrate that illustrated postcards in the era of the great demolitions of the perimeter walls and the razing of the “unhealthy blocks” that the 19th-century city had inherited from the past were not only a small showcase of bourgeois pride, but an active workshop to experiment with the possible forms of a new city, and at the same time also an excellent advertising agency for the creation of consensus around it.

I have always been amazed that Michel Foucault—who described the (almost always visual) languages with which power structures political discourse, a theorist of the panoptic vision as a paradigm of that power, of the splendour of torment as the culmination of the repressive system—as an extraordinary reader of Velázquez's *Meninas*, paid so little attention to the role that power entrusted to urban photography from the beginning. Having the mission to make visible—and above all communicable—the idea of *decorum* as the prime urban virtue; and to condemn its infringement as perverse and threatening: *decay*. This is the pair of concepts that intertwine like *yin* and *yang*, one necessary and complementary to the other, one in the heart of the other, in the photographic images that urban culture feeds on and in which it is reflected.

It is worth mentioning a concept that will sound obvious: all the cities in history wanted to be seen. They all wanted to provide an optical-symbolic equivalent of their power scheme, a visual archetype of which each concrete city was a credible approximation. The ancient city, with the sacred distance of its acropolises from the wooden houses of the commoners. The medieval city, with the fortress of power set like a jewel in the chaotic labyrinth of the village of artisans. The Baroque city, with a linear perspective that forced all eyes to converge on the lord's palace. The bourgeois city, with the curtain of building façades aligned along the avenues, shield, embankment and insurmountable barrier for the proletarian quarters behind them.

Even when it was not done on purpose, the city was designed. Even a spontaneous city is somehow premeditated by the hierarchical relationships that underlie it. But its visual predictability does not reproduce the power it serves without contrast. The prince designs the city, but those who live in it then change it. The lived-in city is the result of an ongoing conflict between public space and private bodies. The function of urban planning, according to Lewis Mumford, is to transform power into form. The city is a power that takes the form of stone, steel, concrete and asphalt.<sup>4</sup>

---

4 Lewis Mumford, *The City in History: Its Origins, Its Transformations, and Its Prospects* (San Diego: Harcourt, Brace & World, 1961).

But this formalisation takes place through conflict. Where urban power is not the arbiter. The planner is one of the players. His task is to organise the city's spaces in such a way as to make it possible to deploy the imperious projects of the dominant classes and interests. The city of the urban planner seeks to maximise the functions consistent with that project while minimising rival positions.

Urban conflict is not made up only of barricades: it is a long, slow underground battle between premeditated spaces and concrete bodies that ultimately produces a vision of the city that may not even match the one foreseen by urban planners. Images are both the battleground and the weapon of these conflicts.

In general, it is the established power that produces images of the city. It has the strength to produce more of them, and more powerful. The promotional and persuasive image of the city emanating from power affirms a principle of adequacy. The appearance of the city must confirm its character as a space maintained under the disciplined control of a project that is by definition beneficial. The bourgeois couplet decorum-decay finds its powerful medieval archetype in the series of frescoes by Ambrogio Lorenzetti for the town hall in Siena, in the form of an exemplary comparison (on the two opposing walls of the Hall of the Nine) between good governance and tyranny. According to Chiara Frugoni's interpretation, it is a powerful propaganda manifesto with which the government of the Nine promised well-being in exchange for consensus, exploiting the fear of citizens in the face of growing urban violence, in the innovative form of a powerfully visual political manifesto where the image of the real city is used both as a source of hope and as a threat. Perhaps for the first time in Western painting, a theory of power was affirmed not only by incarnating it in allegorical figures, but through the realistic representation of lived-in spaces. In Lorenzetti's frescoes, the image of the city and its ideology coincide, they are the same thing.

The city of good governance is therefore the respectable city. The idea of a city that sees any deterioration as threatening precedes the words of political theory with images. Finally formalised in the 1800s, Pierpaolo Ascarì reminds us in his *Corpi e recinti* that the concept of *decorum* shows an extraordinary continuity and adaptability to different regimes, both democratic and authoritarian, from the rhetoric of 19th-century sanitation to the policies of social exclusion in today's cities.<sup>5</sup>

However, all the visual languages with which that concept has been put to work, shown and demonstrated, invoked and imposed in the last two centuries have yet to be analysed. From an iconological point of view, we should ask ourselves what role photography—the medium of choice for the

---

<sup>5</sup> Pierpaolo Ascarì, *Corpi e recinti. Estetica ed economia politica del decoro* (Verona: Ombre corte, 2019).

modern city—played in this process of defining an urban commandment that is inviolable yet constantly subject to conflict.

Which side of the barricades were the photographers on? With the urban powers or the city dwellers? Rereading the history of urban photography under the bright light of that concept, decorum, can offer some surprises.

I am thinking of Eugène Atget, the photographer of early 20th century Paris, who in his own way was a late Baudelairian *flâneur*, barely masked by his utilitarian trade: producing images to sell them. Atget claimed to produce *useful* documents: for the museum curator, for the artist, for the collector, for the artisan. Atget did not work directly for the urban power, although he sold a considerable body of images to the libraries and archives of the city of Paris. Long commandeered by Surrealists, the recent return of his work to the field of documentaries has proven fragile: Atget does not document the Paris of his time. Indeed, he seems to want to avoid the Paris of his time. There is not a single image of the Eiffel Tower in his bottomless archive of thousands of images. Baron Haussmann's disfigurements are also almost completely ignored. It could only have been a specific choice. Atget's Paris is narratively and artificially selected: a city of pavements, shops, streets and corridors, which when animated are populated only with commoners, rag merchants<sup>6</sup> and prostitutes. On closer inspection, they are the same characters as those of Baudelaire.<sup>7</sup> Moreover, Atget and Baudelaire are united by the attention of Walter Benjamin, who see in the photographs of the former something he could have said in some ways of the latter: they seem to be clues collected at the scene of a crime.<sup>8</sup>

But it is not in this capacity, as an inspector on behalf of history, that Atget was embraced by contemporary and subsequent cultures. Collector of an anachronistic marginal city, an alternative to the modern version, he was relegated to being an element of his own scenario. His own biography was subjected to genetic mutation, made to correspond to the romantic narrative of the old photographer, a destitute former actor, dirt poor, who to survive stood on street corners selling his photographs reflecting an immense talent and depth that he himself did not comprehend. But that is not what Atget was. He had left the stage but was a cultured man who continued to lecture on Molière and also directed a satire magazine. He was a refined professional, he called himself an "author-editor," he had an excellent, qualified clientele of over 400 collectors and institutions who during his lifetime bought over 17,000 prints and a few thousand plates from him, he lived and worked in a well-furnished and dignified house-studio with a large library and a collection of high quality prints (which his

---

6 <https://www.getty.edu/art/collection/objects/64726/eugene-atget-chiffonier-french-1899-1901/>

7 Walter Benjamin, *Charles Baudelaire: un poeta lirico nell'età del capitalismo avanzato*, ed. by Giorgio Agamben, Barbara Chitussi, and Clemens-Carl Härle (Vicenza: Neri Pozza, 2012).

8 <https://www.moma.org/collection/works/54255>

photographs show us).<sup>9</sup> Reduced to the caricature of a lame sidewalk photographer, converted into an “artist without knowing it,” Atget was sterilised as a nostalgic visual narrator of that other city, fading, perhaps already lost.

The issue of Atget’s ideological neutralisation raises a question that the text you are reading can only verbalise. By its nature, photography should more naturally be on the side of the second city, the city that resists, the inertial city of life lived by individuals. By its nature the photographic experience is refractory to the totality of urban vision. City photography works by scanning fragments, running along the border between the systematic and premeditated city and the city of anomie, uncertainty, improvisation. In search of the irregular, the disturbing, the transient, the accidental. The photographer contrasts the sweaty collar of the walker to the town planner’s toilette. Urban photography is the irony of urban planning.

Have photographers understood this propensity? Did they indulge it? Did they put it to good use? If yes, which target did they choose, what resistance did they encounter? On the other hand, is there an opposite, compliant photography? Is there a propagandistic photography of decorum?

The answer to this last question must certainly be yes. Urban photography, in all its different genres, has often helped to build an ideology of decorum as a justification for social exclusion. But very often its authors have no names celebrated by the Vasarian stories of photography. They are lesser-known names, often completely unknown, of photographers of commercial urban views. Of illustrated postcards, the first great visual medium of the 20th century, humble and very powerful in their hammering, patient, meticulous work of affirming a bourgeois brand on the face of the historic city. The mosaic of an efficient, clean, decent city was composed of tiles produced in the back offices of stationery stores, tobacco shops and cafés, with cheap and efficient phototype machines producing small runs that allowed the constant updating of the views. Customers always found the latest version of their daily landscape on the racks, as if the images did not tolerate the past but rather urgently pushed towards the new, the healthy, the modern, constantly erasing the old, the dilapidated, the useless.

These vernacular producers, widespread, semi-anonymous, for the masses, obviously had their most famous champions, their models to emulate. In Italy it was definitely the Alinari brothers, whose plates were also used directly for countless series of postcards, as well as an infinite number of artistic-tourism publications dedicated to the “One Hundred Cities of Italy,” sold in newsstands.<sup>10</sup>

---

9 Jacques Bonnet, *Eugène Atget. Un photographe si discret* (Paris: Les belles lettres, 2014). See also *Photographies*, numéro hors-série “Colloque Atget” (Paris: March 1986).

10 Arturo Carlo Quintavalle, *Gli Alinari* (Florence: Alinari, 2003).

The Alinari, a powerful Florentine photography dynasty, also had an extensive selection of “genre” photographs, dedicated to scenarios that today we could call degrading: beggars,<sup>11</sup> common people, street workers. A production that was part of the very commercial *topos* of the picturesque, to which I will return. But the real contribution of the “Alinari style” to the definition of an ideology of urban decorum was the establishment of a norm, of a set of rules of “documentary” representation of urban artefacts, rules that were accepted as legitimate and inviolable for almost a century. More than a style, it was a system that exalted the uniqueness of the architectural artefact, whose epitome was the singular monument,<sup>12</sup> the palace, the architectural and historical edifice considered to be unique), its perfect legibility, its brilliant isolation from the urban context (accentuated through renovation when in reality it was less so), its transformation into a sort of ornament, a manageable, removable object. In short, the style clarified the hierarchical distinction of the city between significant excellence and minor construction, a sort of visual classism that transparently replicated the social layer. Distinguishing between noble and vulgar, unrepeatable and replaceable, the Alinari value scale morally authorised the liberal “sanitising” demolitions of the late 1800s followed by those of the destructive fascist pickaxe.

The implicit link between demolishers and photographers sometimes became apparent. Charles Marville,<sup>13</sup> for example, who a few decades before Atget photographed the chaotic old Paris with its cobblestone streets that continues to inspire nostalgia. Well, Marville’s patron was Baron Haussmann, prefect of the Seine, who was simultaneously demolishing<sup>14</sup> that old Paris to make room for the very respectable *boulevards* (and ballistically convenient in the event of riots) of the world’s capital. The aesthetisation of what was being erased served as an alibi for the radical generic mutation of the urban organism: Marville was the skilful builder of a picturesque city, unfortunately needing to be demolished because it was “unhealthy,” but which could be preserved as a memory in images. Factory of preventive nostalgia, embalming offered as an alibi for real destruction.

Did someone take the side of those who still lived in the city that was about to be erased? Yes, on the other side of the barricade—at least this is what the common historical-photographic story tells us—there were noble photographers documenting the injustices and distortions of the bourgeois city. Humanitarian and reformist photographers who used their craft to denounce the miserable conditions of the city that the other photography ignored: the desolate city of the proletariat, the marginalised, the poor.

---

11 <https://www.alinari.it/en/detail/GBB-F-005614-0000>

12 <https://www.alinari.it/en/detail/GBB-F-007382-0000>

13 <https://www.moma.org/collection/works/51489>

14 <https://www.metmuseum.org/art/collection/search/307389>

Strangely forgiving of the commonplace, Marshall McLuhan believed that “To see a photograph of the local slum makes the condition unbearable.”<sup>15</sup> Who were the images of decay taken by those visual scouts really meant for? Not grassroots emancipation movements. The confidence in the effectiveness of reporting by means of images was based on an appeal to the conscience and perhaps to the prudence of the rich. They were warnings not to overly compress a spring that could snap back in unpleasant ways.

The mission of “bringing the light” to the dark ravines of society was explicitly taken on by the journalist and social reformer Jacob Riis in the vast investigation with which he denounced the conditions of the filthy tenements for immigrants in lower Manhattan. Riis brought that light with his magnesium flash (which sometimes set straw mattresses on fire and risked toasting the objects being photographed) in the slums of those same Italian immigrants that he had previously captured on film on Ellis Island. Riis justified his intrusive and aggressive view<sup>16</sup> with the conviction that he was a social explorer with a self-assigned mandate to blow the lid off of hell to reveal it to the eyes of those who would never enter the slums despite living in the same city, but rather feared the threatening<sup>17</sup> decay from afar.<sup>18</sup> Supported by a conservative populist president, Theodore Roosevelt, Riis is rightly defined by Antonello Frongia as an urban planner, albeit of a very particular kind, a sort of freelancer offering “a view that unfolds before the citizens without the mediation of codified representation systems.”<sup>19</sup> The images that Riis projected with a magic lantern during his lectures worked as an incitement to a policy of slum clearance, of urban reclamation, conveying the problem of decay that previously did not exist as such through images. But in this way the images themselves became the real problem to be solved. It was the bothersome presence of those images in the public discourse that needed to be removed.

In fact, the eruption of images of decay in the consciousness of the wealthy classes helped to change the disposition of the urban objects, especially in an exemplary case: the crumbling block of Mulberry Bend<sup>20</sup> on the Lower East Side where Riis had focused his investigative efforts was demolished by the city and replaced with a nice park<sup>21</sup> after a long and controversial affair during which the photographer even ended up suing the city of New York, guilty of not removing the rubble that had

---

15 Marshall McLuhan, *Understanding Media* (New York: McGraw-Hill, 1964), 214.

16 <https://www.moma.org/collection/works/51194>

17 <https://www.moma.org/collection/works/50859>

18 Jacob A Riis, *How the Other Half Lives. Studies Among the Tenements of New York, with 100 Photographs from the Jacob A. Riis Collection, and a New Preface by Charles A. Madison* (New York: Scribner's, 1890). <https://doi.org/10.1037/12986-000>.

19 Antonello Frongia, *Locchio del fotografo e l'agenda del planner. Studio su Jacob A. Riis* (Venice: Toletta, 2000), 269.

20 <https://www.moma.org/collection/works/51022>

21 <https://collections.mcny.org/Collection/Mulberry%20Bend%20Park.%20%20New%20York-24U39Y24I50.html>

been left abandoned on the spot. In retaliation he was not invited to the inauguration of Mulberry Park but snuck in all the same, ironically getting reprimanded by a policeman because he walked on the newly planted grass. Nonetheless he proudly laid claim to the powerful effect of his *Battle with the Slum*: "Go look at it today and see how it is..., decent and orderly because sunlight can now enter and shine down on the children who had the right to play there."<sup>22</sup> But Riis's photographs did not follow the trail of the inhabitants evicted from that demolished block, probably marginalised in the Bronx, or in Brooklyn or other second-step migratory cities like Chicago. Once out of the frame, the problem disappeared simultaneously from the philanthropist's good conscience and the administrator's embarrassment.

In the same years as Hine, painter and lithographer Heinrich Zille<sup>23</sup> wandered around the miserable Mietskasernen of Berlin. For Gisèle Freund he was "the first 'concerned' photographer,"<sup>24</sup> but today we would call him a freelancer. Perhaps the first explorer of urban squalor on an explicit mandate from the community was the Scot Thomas Annan,<sup>25</sup> who in 1866 provided the Glasgow City Improvement Trust with visual documentation of the city's overcrowded slums. In contrast, in 1896 a package of ordered and numbered photographs was presented to the British Parliament by Dr. James Spottiswoode Cameron, the doctor in charge of monitoring the health conditions of the ultraproletarian block of Quarry Hill in Leeds. Sceptical, the honourable parliamentarians asked him if he intended to route people up with postcards.<sup>26</sup> This question was sarcastic but not without foundation: the photographs provided by Cameron were really postcards, almost completely devoid of people, his idea of renewal was a technical project entrusted to professionals of "sanitising enthusiasm" working on people who were required to remain passive objects of study and intervention. The residents of the neighbourhood to be renewed were never consulted.

This kind of photography, which was supposed to be clinical, investigative, classifying, cataloguing was obviously not so objective: it was the view of the bourgeoisie of the West that cast away the human consequences of industrialism from itself and from its responsibilities. With his presumption of mechanical truthfulness, photography was the perfect alibi for this alienation. For a curious paralogism, since photography reproduces nature as it is, everything that is photographed belongs to nature. And photography thus naturalises poverty as an element of the social landscape.

---

22 Jacob A. Riis, *The Battle with the Slum* (New York: Courier Corporation, 2013), 291.

23 <http://www.zeno.org/nid/2000191023X>

24 Gisèle Freund, *Photographie et société* (Paris: Seuil, 1974); English translation *Photography and Society*, trans. David R. Godine (Boston: David R. Godine, 1980), 93.

25 <https://www.moma.org/collection/works/50414>

26 Cited in John Tagg, *The Burden of Representation. Essays on Photographies and Histories* (Minneapolis: University of Minnesota Press, 1988), 143.



As written by Adolphe Smith, a socialist journalist, in the preface to *Street Life in London*, reportage by John Thomson,<sup>27</sup> 1877:

The unquestionable accuracy of this testimony will enable us to present true types of the London Poor and shield us from the accusation of either underrating or exaggerating individual peculiarity of appearance.<sup>28</sup>

The message is clear: photographers do not create poverty, they only document it, with the most scientific and unassailable tool and method.

The moral mechanism of showing things to correct them tends to hide its most serious mystification behind a humanitarian alibi. This kind of photography establishes a linear link between two points: the victim of fall and his benefactor. As Roland Barthes observed while deconstructing the photographs of the Abbé Pierre,<sup>29</sup> when the image of the benefactor, the saviour, invades the iconography of suffering, then it becomes “the alibi...to replace the signs of charity with the reality of justice with impunity.”<sup>30</sup> In fact, a third character is carefully kept out of the frame: the person responsible. The obliteration of the persecutor from the field of the image results in his concealment in public discourse. It is a well-known mechanism employed in the iconography of humanitarian agencies seeking funds. The hunger is visible. The benefactor acts. The person responsible for the conditions that produce the hunger is nowhere to be seen. As Luc Boltanski theorises in *Distant Suffering*, the dissymmetry between the two actors who remain on the field, the victim and the benefactor (who in our case enters the photograph as the author of the image: the unveiling photographer), functions as a powerful mechanism of impunity for those politically responsible for the inequalities.<sup>31</sup> Like bathtubs, the photograph of the decay seems to have an overflow drain: if the scandal produced should exceed the level of safety and transform reassuring philanthropy into rebellion, the photographer himself is blamed as the culprit. The pain and anger at what we see happening to the victim is unleashed on those who show it to us. Because who else is there in the scene? Nobody. The photographer would like to be a willing witness, but is often dismayed to be identified as the alter ego of the invisible executioner, his shadow. The photographer who shows the effects of social inequality is singled out by the viewer of the images as a profiteer, a speculator, an exploiter of poverty. Unable to detail the chain of causes and effects that generates misery, an aetiology that lies outside his images, the photographer becomes a pornographer. If pornography is defined as a representation

27 <https://digital.library.lse.ac.uk/objects/lse:gox325doj>

28 Cited in Beaumont Newhall, *The History of Photography* (New York: The Museum of Modern Art, 1982), 146.

29 <https://idata.over-blog.com/0/07/64/28/abbe-pierre/abbe-pierre3.jpg>

30 Roland Barthes, *Mythologies* (Paris: Seuil, 1957); English translation *Mythologies*, trans. Annette Lavers (New York: Farrar, Straus & Giroux, 1972), 49.

31 Luc Boltanski, *La souffrance à distance* (Paris: Métailié, 1993).

that satisfies desire through the image itself that aroused it, photography depicting decay is pornography. It satisfies our need for moral compensation with the same images that created it.

In Italy, in any case, the institutions did not even want to run the relative risk of a consolatory and atoning photograph. Here, the great social surveys advanced by the parliament of the young unitary kingdom did without photographs, and not because they were not technically available, but because they were aware that photographs would not produce

those uniquely interpretable data that the statistical rigour of those in charge demanded.

Thus photography of misery remained the prerogative of two different but complementary photographic records. Postcard racks<sup>32</sup> and police records.<sup>33</sup> These were the two languages used to express post-unitarian decay in Italy, defusing its explosive potential. Picturesque and repressive.

In 1910, Gustavo Bonaventura wrote in *La Fotografia Artistica*, the flagship magazine of Italian photographic pictorialism:

...the immense human selfishness neglects to suffer seeing an old man sleep on a bench on a cold winter night and a mother feed her hungry, unruly children with tears. They are pains that are not thought of because they are pains that you look at without seeing them, worried by the thought of a good night's rest and a full stomach, while they could instead serve to produce an extensive series of images marked by the sad, bitter poetry of misery and martyrdom.<sup>34</sup>

The moral is very clear: woe to the photographer who turns away when he sees a wretch as it would be a gigantic waste of excellent artistic ideas! An excellent synthesis of the philosophy of that subgenre that runs throughout the history of photography, which someone has given the name of *miserabilism*. That is, the satisfaction of representing poverty in images, transcended in the poetics of rags.

The photographers finally ended up going there on behalf of the State, to the shadowy South, but following weapons and not the notebooks of the southerners. They went to photograph the peasants recruited by the brigand leaders, portraying them preferably dead,<sup>35</sup> dehumanised corpses, the inglorious trophy of a war against our Apaches and Sioux, who did not even have the ambiguous gift of being ennobled in an epic film of the far south.

---

32 <https://i.pinimg.com/originals/29/92/e8/2992e813d1b8d79e9d0beeb560197cfd.jpg>

33 <https://www.italianways.com/wp-content/uploads/2019/09/Mostra-Lombroso-9.jpg>

34 Cited in Paolo Costantini, *La fotografia artistica 1904-1917. Visione italiana e modernità* (Turin: Bollati Boringhieri, 1990), 168.

35 [https://upload.wikimedia.org/wikipedia/commons/1/1b/Nicola\\_Napolitano.jpg](https://upload.wikimedia.org/wikipedia/commons/1/1b/Nicola_Napolitano.jpg)

Is it possible to escape the claws that twist photographs of social inequalities against themselves? What kind of photographic approach allows one to navigate between the twin rocks of decorum and decay without crashing against one of the two?

It is appropriate to acknowledge some photographers who in recent years were more aware of the risk, who fought against the complicit tendency of photography.

Martha Rosler,<sup>36</sup> an American feminist artist, devised an alternative kind of documentary reportage in the 1970s, with a now iconic work on the “road of drunks” in Manhattan: *The Bowery in Two Inadequate Descriptive Systems*. The exhibition and accompanying book were structured in diptychs of words and images, side by side with each other. Both the “inadequate descriptive systems” explicitly rejected any evaluative rhetoric. The words were lists of nouns and adjectives related to the semantic cluster of marginalisation, while the photographs—devoid of human beings—frontally framed the fronts of the shops where homeless people lay to sleep at night. “They are not reports from a frontier, messages from a voyage of discovery or self-discovery,”<sup>37</sup> the author explained.

Rather than pretending to reveal something new about the precarious condition of an urban setting, the work was a radical criticism not only of the reformist ethics of revelation, but of the very possibility of a documentary photography of poverty: “The common acceptance of the idea that documentary precedes, supplants, transcends or cures full, substantial activism is an indicator that we do not yet have a real documentary.”<sup>38</sup>

In short, when presented as a pure and simple documentation of decay, urban photography inevitably tends towards the side of urban power: what it depicts does not cause distress, but rather strengthens the security-related and exclusionary response of the powers that be, for which the representation of decay—far from being troublesome—is useful because it is exploited to support bullying requests for decorum.

In Italy, however, the trap to avoid was not the tradition of humanitarian and reformist photography. Here, as I said, the Alinari paradigm weighed on the view of the city, with its architectural metonymy of the social hierarchy and the picturesque vaccine of clothes hung out to dry. A generation of socially conscious photographers therefore chose to ignore the documentary-social genre and focus their criticism on sightseeing-monumental images. The effort was led by a group brought together by one of the rare Italian photography intellectuals, Luigi Ghirri.<sup>39</sup>

---

36 <https://journals.openedition.org/ideas/docannexe/image/5233/img-2.jpg>

37 Cited in Steve Edwards, *Martha Rosler: The Bowery in Two Inadequate Descriptive Systems* (Cambridge, Mass.: MIT Press, 2012), 26.

38 *Ibid.*, 81.

39 <https://archivioluigighirri.com/artworks/italia-ailati>

*Viaggio in Italia*,<sup>40</sup> published in 1984,<sup>41</sup> a rare example of balance between individual artistic sensitivities and collective projects, followed the trail of revolutionary anti-photographers of the contemporary American landscape: pop-sensitive photographers such as Stephen Shore,<sup>42</sup> whose raw depictions of car parks, intersections and highways oppressed by neon from the outset seemed like a fierce critique of a model of urban development based on products and cars. The images of the authors of that school even flummoxed the American radical scene: they deliberately renounced all ethical and political judgements on what they portrayed. They did not attribute value, but rather measured space. They did not say, "This is where we want to live." Nor did they say, "This is where you can still live." They simply said: "This is where we're living. Let's at least open our eyes." The intent of those photographers was not to show cynicism. To the contrary, they considered themselves the new realists, but in a specific sense: they knew that photography is not a reflection of the real world, but rather a new object that is placed in the world and that changes the way we perceive other objects. It is a sign among other signs. Terribly efficient.

But were those photos that contemporaries saw as trivial and boring really so anti-judgemental? Or, as seems to me to be better understood today, behind that apparent neutrality ("today our landscape looks like this...") was there still a barely concealed, sarcastic and even a little snobby aesthetic judgement ("...that is, it's squalid")?

The choice made explicitly by Ghirri's group during that celebrated yet not entirely understood *Viaggio* was the cancellation of value hierarchies, the discovery and affirmation that the real landscape is not just an "interesting" view but rather what we see on a daily basis, it is also the suburbs, apartment buildings with palladium and anodised aluminium, barns made with scraps of billboards cobbled together, the landscape that is *seen* but not *perceived*, which must be brought back to awareness, a necessary preliminary step for any possible cleansing of views overloaded with dirty signs. There was, therefore, at least in the intentions repeatedly expressed by Ghirri, a focus on the ecology of the view. And this somehow conveyed an ethical-aesthetic judgement: the condemnation of the "degraded" landscape was clearly implied, though no longer aimed at the landscape itself but rather at its perception. The degraded landscape is ugly because it is *disdained*, not perceived, not addressed.

This way, however, thrown out the door, the ghost of the Alinari came back in through the window. A change in sign, but not in direction. In a recent interview with the author, Guido Guidi,<sup>43</sup> who was part of that group and is

---

40 <http://www.mufoco.org/digitalexhibitions/en/portfolio/1984-travel-photography-in-italy/>

41 Luigi Ghirri and Gianni Leoni, *Viaggio in Italia*, edited by Enzo Velati (Alessandria: Il Quadrante, 1984).

42 <https://www.moma.org/collection/works/165376>

43 <https://i1.wp.com/www.rivistastudio.com/wp-content/uploads/2019/10/4.jpg?resize=800,634&ssl=1>

still the standard bearer for that approach, when asked about the aesthetic appeal that the non-monumental and non-interesting landscape aroused in the eyes of that group, replied as follows: "Suburbs that are aesthetically out of control are much more interesting, and true, than certain historic city centres dominated by the power of everything-in-its-place, the artifice of decorum."<sup>44</sup>

And so, without taking anything away from the disruptive value of that operation, which changed the approach to the Italian landscape and the very history of our photography once and for all, I think it can be said that it also included a form of landscape poetisation with inverted values. There was a choice by the authors of what might become interesting if looked at *in a certain way*, even if it had not been considered interesting before. That which was non-conforming was sublimated, transcended into poetic. After all, the suburbs are truly the place of social marginalisation, and their appearance is the warning light: metabolised as a sort of new sublime imperfection, this landscape of discrimination slipped towards the risk of being proposed as acceptable, metabolised, justified.

Due to disagreements about the project, at the last minute Roberto Salbitani<sup>45</sup> refused to be part of the *Viaggio in Italia* group. Ghirri had such a high opinion of Salbitani that his artisanal publishing house had published a crucial work by him entitled *La città invasa*, which in a hard, anti-lyrical black and white looked at the invasion, infestation and *decay* induced by wall advertising in the urban landscape.<sup>46</sup> Assertive, judgemental photographs, anything but aseptic, that rubbed salt on a wound, affirming that decay is not only that which is spontaneous, abnormal, irregular and illegal, but it is also designed, premeditated and functional to the mechanisms of the market.

Perhaps the time has come to ask ourselves the question if decay is the necessary complement to *decorum*, then photographically representing decay seems to leave only two alternatives, both worrying: invoking a policy of decorum, with everything it means in terms of gentrification, exclusion and class expulsion; or circumventing the problem on a purely aesthetic level.

This is the same dilemma that environmental photography has had to deal with in recent decades. And it does not seem to have resolved the issue. Think of the most advanced cultural product available to date, *Anthropocene*,<sup>47</sup> the multimedia work that in many ways can be considered epic, coordinated by Edward Burtynsky. It portrays a planet that has entered the geological era of its disintegration due entirely to human causes, and does so through cutting-edge technologies (visual

---

44 Interview with the author, *Il Venerdì di Repubblica*, 21 February 2020

45 <https://salbitani.it/la-citta-invasa/>

46 Roberto Salbitani, *La città invasa* (Modena: Punto e Virgola, 1979).

47 <https://anthropocene.mast.org/en/>

hypertextuality, 3D, animations) that are the most advanced product of that same technical and scientific civilisation. The means seem to contradict the alarm and to affirm, unforeseeably in tune with developmental ideologies, that salvation from the climate catastrophe could come from greater investment in technologies rather than from some extreme idea.

The question stubbornly persists: might urban photography, whether it glorifies decorum or stigmatises decay, serve the interests of social exclusion? Will the photography of public spaces, with the weight of its seemingly inexorable relationship with the world as we see it, inevitably tend to have a reactionary core?

I believe that we must face an issue that photography has always avoided, fearing that it was unable to resolve it: how one can produce an image of the urban environment that includes a return in terms of inclusion, justice, citizenship. Unfortunately, photography is as good at conveying what exists as it is ambiguous at portraying what should be. To affirm a proposal photography needs a conversation, which the pure, simple visual language does not provide. Unfortunately, this limit is difficult to accept for those who have chosen this language as their intellectual weapon. Photographers are often wary of the words that accompany and condition the comprehension of their images. There is an ancient suspicion of captions, which in Walter Benjamin's—in truth logocentric—opinion was the only revolutionary avenue of redemption for the polysemy of the image. A vision that led to a long “progressive” submission of photographs to other people's words, from Bertolt Brecht's *Kriegsfibel*<sup>48</sup> to Edward Steichen's epochal exhibition *The Family of Man*.<sup>49</sup> Models the photographers soon moved away from. In the golden age of American street photography, compulsive hunters of sidewalk images like Garry Winogrand,<sup>50</sup> Lee Friedlander<sup>51</sup> and Diane Arbus<sup>52</sup> no longer oppressed their images with captions. But those images could be interpreted all the same, being part of a context of critical and anti-institutional counterculture that was opening up gaps of meaning in the walls of urban ideology. I think I can say that the photographs of those authors reveal their true meaning only if read in light of a hymn to street community resistance like Jane Jacobs' *The Death and Life of Great American Cities*.<sup>53</sup>

But when that context does not exist, when criticism of development models fades in public discourse, then what can photography do? How is it

---

48 Bertolt Brecht, *Kriegsfibel* (Berlin: Eulenspiegel, 1955).

49 Edward Steichen, *The Family of Man*, prologue by Carl Sandburg (New York: The Museum of Modern Art, 1995).

50 <https://www.metmuseum.org/art/collection/search/262308>

51 <http://fraenkelgallery.com/wp-content/uploads/2012/01/LF-79-06.jpg>

52 <https://www.metmuseum.org/art/collection/search/284712>

53 Jane Jacobs, *The Death and Life of Great American Cities* (New York: Random House, 1961).

possible to create a meaningful context around photographs that includes the critical role of the word without turning them back into illustrations?

Perhaps it is a task that no longer demands only the view of a photographer, but the thoughts of a relationship builder that go beyond the images. Let me conclude with an example that perhaps points us to a possible future. Délio Jasse<sup>54</sup> is a young Angolan photographer who dealt with the tormented story of the independence of his country in a surprising way.<sup>55</sup> Even the photographs he had accumulated over time portray deterioration: that of post-colonial construction and urban planning, in a country first devastated by civil war today attacked by the sparkling promise of reconstruction by the Chinese. But Jasse does not leave the photos in his archive in their pure, simple form attesting to a state of affairs. He juxtaposes them, weaves them, distorts them. The buildings of the Portuguese rulers overlap transparently with the skyscrapers of the Eastern construction companies. The inherited colonial decay and the neo-colonial decorum mingle and scream in a paradox: the decadence of the colonial age tells us of freedom conquered, the shining, new, clean neo-colonial order tells us of a return to possible oppression. And while the façades of the buildings tend to conceal the relations of domination, Jasse pulls them out forcefully in the form of the imprint (golden, presumptuous) of bureaucratic and commercial stamps of the Portuguese era, found by him, which gradually obliterate those images with arrogance: “sample without value,” “paid,” “unimportant copy.”

Jasse’s conceptual device is simple, understandable: decay and decorum are shown as two sides of the same coin, two useful ingredients of a continuous line of expropriation of a people’s self-government.

If this is possible, then we can be hopeful that photography is not necessarily condemned by its nature and its limits to be placed at the service of urban powers. It is not necessarily the handmaid of decorum, under the guise of the chronicler of decay.

Indeed, images can unmask the stamp of power on the ideology of the beautiful, good and orderly city.

---

54 <https://www.fotoindustria.it/mostre/archivo-urbano/>

55 Francesco Zanot, “Délio Jasse. Arquivo Urbano,” in *Arquivo Urbano Délio Jasse. Foto/Industria. IV Biennale Di Fotografia Dell’industria e Del Lavoro*. Tecnosfera (Bologna: Mast, 2019).

**Michele Smargiassi** has been politics and society correspondent of the Italian daily *La Repubblica*. He writes the blog *Fotocrazia*. He is a member of the board of the *Centro Italiano per la Fotografia d'Autore* in Bibbiena. He is author of *Un'autentica bugia. La fotografia, il vero, il falso* (2009), *Ora che ci penso. La storia dimenticata delle cose quotidiane* (2011) and *Sorridere. La fotografia comica e quella ridicola* (2020).



## References

- Anthropocene*. Burtynsky Baichwal De Pencier, Toronto: Ago, 2018.
- Ascari, Pierpaolo. *Corpi e recinti. Estetica ed economia politica del decoro*. Verona: Ombre corte, 2019.
- Barthes, Roland. *Mythologies*. Paris: Seuil, 1957.
- Batchen, Geoffrey. *Burning with Desire. The Conception of Photography*. Cambridge, Mass. - London: MIT Press, 1997.
- Benjamin, Walter. *Charles Baudelaire: un poeta lirico nell'età del capitalismo avanzato*. Edited by Giorgio Agamben, Barbara Chitussi, and Clemens-Carl Härle. Vicenza: Neri Pozza, 2012.
- . "Das Kunstwerk Im Zeitalter Seiner Technischen Reproduzierbarkeit." In *Schriften*. Frankfurt am Main: Suhrkamp Verlag, 1955.
- Boltanski, Luc. *La souffrance à distance*. Paris: Métailié, 1993.
- Bonnet, Jacques. *Eugène Atget. Un photographe si discret*. Paris: Les belles lettres, 2014.
- Brecht, Bertolt. *Kriegsfiabel*. Berlin: Eulenspiegel, 1955.
- Costantini, Paolo. "La fotografia artistica" 1904-1917. *Visione italiana e modernità*. Turin: Bollati Boringhieri, 1990.
- Edwards, Steve. *Martha Rosler: The Bowery in Two Inadequate Descriptive Systems*. Cambridge, Mass.: MIT Press, 2012.
- Freund, Gisèle. *Photographie et société*. Paris: Seuil, 1974.
- Frongia, Antonello. *L'occhio del fotografo e l'agenda del planner. Studio su Jacob A. Riis*. Venice: Toletta, 2000.
- Frugoni, Chiara. *Paradiso vista Inferno. Buon governo e tirannide nel medioevo di Ambrogio Lorenzetti*. Bologna: Il Mulino, 2019.
- Ghirri, Luigi, and Gianni Leoni. *Viaggio in Italia*. Edited by Enzo Velati. Alessandria: Il Quadrante, 1984.
- Jacobs, Jane. *The Death and Life of Great American Cities*. New York: Random House, 1961.
- McLuhan, Marshall. *Understanding Media*. New York: McGraw-Hill, 1964.
- Mumford, Lewis. *The City in History: Its Origins, Its Transformations, and Its Prospects*. San Diego: Harcourt, Brace & World, 1961.
- Newhall, Beaumont. *The History of Photography*. New York: The Museum of Modern Art, 1982.
- Photographies*. Numéro hors-série "Colloque Atget." Paris. March 1986.
- Quintavalle, Arturo Carlo. *Gli Alinari*. Florence: Alinari, 2003.
- Riis, Jacob A. *How the Other Half Lives. Studies Among the Tenements of New York, with 100 Photographs from the Jacob A. Riis Collection, and a New Preface by Charles A. Madison*. New York: Scribner's, 1890. <https://doi.org/10.1037/12986-000>.
- . *The Battle with the Slum*. New York, 1902, reprint: New York: Courier Corporation, 2013.
- Salbitani, Roberto. *La Città invasa*. Modena: Punto e Virgola, 1979.

Steichen, Edward. *The Family of Man. Prologue by Carl Sandburg*. New York: The Museum of Modern Art, 1995

Tagg, John. *The Burden of Representation. Essays on Photographies and Histories*. Minneapolis: University of Minnesota Press, 1988.

Zanot, Francesco. "Délio Jasse. Arquivo Urbano." In *Arquivo Urbano Délio Jasse. Foto/Industria. IV Biennale Di Fotografia Dell'industria e Del Lavoro*. Tecnosfera. Bologna: Mast, 2019.