



ALMA MATER STUDIORUM
UNIVERSITÀ DI BOLOGNA

ARCHIVIO ISTITUZIONALE
DELLA RICERCA

Alma Mater Studiorum Università di Bologna Archivio istituzionale della ricerca

Generalized Samuel Multiplicities of Monomial Ideals and Volumes

This is the final peer-reviewed author's accepted manuscript (postprint) of the following publication:

Published Version:

Achilles R., Manaresi M. (2022). Generalized Samuel Multiplicities of Monomial Ideals and Volumes. EXPERIMENTAL MATHEMATICS, 31(2), 611-620 [10.1080/10586458.2019.1671919].

Availability:

This version is available at: <https://hdl.handle.net/11585/729776> since: 2022-11-07

Published:

DOI: <http://doi.org/10.1080/10586458.2019.1671919>

Terms of use:

Some rights reserved. The terms and conditions for the reuse of this version of the manuscript are specified in the publishing policy. For all terms of use and more information see the publisher's website.

This item was downloaded from IRIS Università di Bologna (<https://cris.unibo.it/>).
When citing, please refer to the published version.

(Article begins on next page)

This is the final peer-reviewed accepted manuscript of:

Rüdiger Achilles & Mirella Manaresi (2019) Generalized Samuel Multiplicities of Monomial Ideals and Volumes, Experimental Mathematics.

The final published version is available online at:
<https://doi.org/10.1080/10586458.2019.1671919>

Rights / License:

The terms and conditions for the reuse of this version of the manuscript are specified in the publishing policy. For all terms of use and more information see the publisher's website.

This item was downloaded from IRIS Università di Bologna (<https://cris.unibo.it/>)

When citing, please refer to the published version.

Generalized Samuel Multiplicities of Monomial Ideals and Volumes

Rüdiger Achilles and Mirella Manaresi

QUERY SHEET





This page lists questions we have about your paper. The numbers displayed at left are hyperlinked to the location of the query in your paper.

The title and author names are listed on this sheet as they will be published, both on your paper and on the Table of Contents. Please review and ensure the information is correct and advise us if any changes need to be made. In addition, please review your paper as a whole for typographical and essential corrections.



Your PDF proof has been enabled so that you can comment on the proof directly using Adobe Acrobat. For further information on marking corrections using Acrobat, please visit <http://journalauthors.tandf.co.uk/production/acrobat.asp>; <https://authorservices.taylorandfrancis.com/how-to-correct-proofs-with-adobe/>

The CrossRef database (www.crossref.org/) has been used to validate the references.

AUTHOR QUERIES

- Q1**  Please confirm that the numbering of equations has been set correctly.
- Q2**  The Ref. [10] is listed in the references list but is not cited in the text. Please either cite the reference or remove it from the references list.
- Q3**  Please provide complete author information and year of publication for Ref. [11]
- Q4**  Please provide the missing editors name for Ref. [17].
- Q5**  The ORCID details of the authors have been validated against ORCID registry. please check the ORCID ID details of the authors.

Generalized Samuel Multiplicities of Monomial Ideals and Volumes

 Rüdiger Achilles  and Mirella Manaresi 
Dipartimento di Matematica, Università di Bologna, Bologna, Italy

ABSTRACT

We describe conjecturally the generalized Samuel multiplicities c_0, \dots, c_{d-1} of a monomial ideal $I \subset K[x_1, \dots, x_d]$ in terms of its Newton polyhedron $\text{NP}(I)$. More precisely, we conjecture that c_i equals the sum of the normalized $(d-i)$ -volumes of pyramids over the projections of the $(d-i-1)$ -dimensional compact faces of $\text{NP}(I)$ along the infinite-directions of i -unbounded facets in which they are contained. For c_0 proofs are known (Guibert, Jeffries and Montaña) and for c_{d-1} a proof is given.

KEYWORDS

monomial ideal; generalized Samuel multiplicity; Newton polyhedron

2010 MATHEMATICS

SUBJECT

CLASSIFICATION

Primary 13H15; Secondary 13F20; 52B20

1. Introduction

In this paper, based on computations with the free softwares Germenes [14] and REDUCE [11], we give a conjecture that in the case of monomial ideals links the generalized multiplicities defined algebraically in [3] with volumes derived from the Newton polyhedra of the ideals, thus extending a result of Teissier [17].

In 1988, Teissier [17, p. 131] proved that for an \mathfrak{m} -primary monomial ideal I of a local ring A the Samuel multiplicity is equal to the normalized volume of the complement of the Newton polyhedron of the ideal I . In 1999, Guibert [9] generalized Teissier's result. Precisely, Guibert defines the local Segre class of an ideal generated by a set of germs of holomorphic functions and, under a non-degeneracy condition, he describes such a class by Minkowski mixed volumes of polytopes. As a special case he obtains that for a certain class of monomial ideals the local Segre class is a normalized volume of the simplex generated by the origin and the vertices of the Newton polyhedron, see [9, 4.2]. By [4], the local Segre class is the so called j -multiplicity of the ideal. In 2013, Jeffries and Montaña [13] gave a different proof that the j -multiplicity of a monomial ideal is the normalized volume of the pyramid of the ideal.

The j -multiplicity of an ideal is different from zero if and only if its analytic spread is maximal, that is, equal to the Krull-dimension d of A . A result of Bivià-Ausina [6] states that the analytic spread diminished by one is the maximum of the dimensions of compact faces of the Newton polyhedron of I .

According to [3] the j -multiplicity is the first coordinate of the generalized Samuel multiplicity vector $c(I) = (c_0(I), \dots, c_d(I))$. Here we present and illustrate a conjecture which expresses the other components of $c(I)$ in terms of

the Newton polyhedron of I . Our conjecture holds for $c_0(I)$ by the known result of Guibert and of Jeffries and Montaña, and we shall prove it here for $c_{d-1}(I)$.

2. Generalized Samuel multiplicities

This section is a quick review of a generalization of Samuel's multiplicity by a sequence of numbers, the so-called generalized Samuel multiplicity, which we introduced in [3].

Let A be a d -dimensional Noetherian local ring (A, \mathfrak{m}) with unique maximal ideal \mathfrak{m} or a standard graded algebra $A = \bigoplus_{i \geq 0} A_i$ such that A_0 is a field and $\mathfrak{m} = (A_1)A$ is the unique homogeneous maximal ideal of A . Let $I \subset A$ be an arbitrary ideal (not necessarily \mathfrak{m} -primary).

In order to define the generalized Samuel multiplicity $c(I)$, consider $G_I(A) := \bigoplus_{j \geq 0} I^j / I^{j+1}$, the associated graded ring of A with respect to I and the bigraded ring

$$T = \bigoplus_{i, j \geq 0} T_{ij} = G_{\mathfrak{m}}(G_I(A)) = \bigoplus_{i, j \geq 0} \frac{\mathfrak{m}^i I^j + I^{j+1}}{\mathfrak{m}^{i+1} I^j + I^{j+1}},$$

where $T_{00} = A/\mathfrak{m} = K$ is a field.

Let $H^{(0,0)}(i, j) := \dim_K T_{ij}$ be the Hilbert function of the bigraded ring T and let

$$H^{(1,1)}(i, j) := \sum_{q=0}^j \sum_{p=0}^i H^{(0,0)}(p, q)$$

be its twofold sum transform. For both $i, j \gg 1$ this function becomes a polynomial in (i, j) , which can be written in the form

$$\sum_{k+l \leq d} a_{k,l}^{(1,1)} \binom{i+k}{k} \binom{j+l}{l}.$$

Following [3] define the *generalized Samuel multiplicity* to be the vector

$$\begin{aligned} (a_{0,d}^{(1,1)}, a_{1,d-1}^{(1,1)}, \dots, a_{d,0}^{(1,1)}) &=: (c_0(T), c_1(T), \dots, c_d(T)) =: c(T) \\ &=: (c_0(I), c_1(I), \dots, c_d(I)) =: c(I). \end{aligned}$$

The first coefficient $c_0(I)$ plays an important role as an intersection number and was introduced in [2]. It is called the j -multiplicity $j(I) := c_0(I)$. The last coefficient $c_d(I)$ is zero if $\dim(A/I) < d = \dim(A)$, see [3, Proposition 2.3]. In particular, if $I \neq 0$ is a monomial ideal in a polynomial ring, then $c_d(I) = 0$.

The generalized Samuel multiplicities depend only on the highest dimensional components of T , see [18] or [3, Proposition 1.2]:

Proposition 1. *Let Q_i , $i = 1, \dots, q$, be the highest dimensional primary ideals in a minimal primary decomposition of the zero ideal of the bigraded ring $T = G_m(G_I(R))$ and P_i their associated prime ideals. Then there is an equality of vectors*

$$c(I) = c(T) = \sum_{i=1}^q \text{length}(T_{P_i}) \cdot c(T/P_i) = \sum_{i=1}^q c(T/Q_i).$$

By analogy with the application of $c(I)$ to intersection theory, we shall call $c_k(T/Q_i) \neq 0$ a *movable contribution* to $c_k(I)$ if there is an integer $\ell > k$ such that $c_\ell(T/Q_i) \neq 0$.

3. A conjecture and some results

Let I be an ideal in $R = K[x_1, \dots, x_d] = K[\mathbf{x}]$ (K a field) minimally generated by the monomials

$$\mathbf{x}^{v_1} := x_1^{v_1(1)} \dots x_d^{v_1(d)}, \dots, \mathbf{x}^{v_r} := x_1^{v_r(1)} \dots x_d^{v_r(d)},$$

that is, $v_1 = (v_1(1), \dots, v_1(d)), \dots, v_r = (v_r(1), \dots, v_r(d))$ are the points of $\mathbb{Z}_{\geq 0}^d$ corresponding to the exponents of the generators of I .

The *Newton polyhedron* $\text{NP}(I)$ of I is defined as the convex hull of $\{v \in \mathbb{Z}_{\geq 0}^d \mid \mathbf{x}^v \in I\}$ in \mathbb{R}^d , that is,

$$\begin{aligned} \text{NP}(I) &:= \text{conv}(\{v \in \mathbb{Z}_{\geq 0}^d \mid x_1^{v(1)} \dots x_d^{v(d)} \in I\}) \\ &= \text{conv}(\{v_1, \dots, v_r\}) + \mathbb{R}_{\geq 0}^d, \end{aligned}$$

where $+$ denotes the Minkowski sum (for the equality see [15, Lemma 4.3]). It is well-known (see, for example, [12, Proposition 1.4.6]) that the set of integer lattice points of $\text{NP}(I)$ equals the exponent set of the integral closure of I , which is again a monomial ideal. Our conjectures involve both $\text{NP}(I)$ and the generalized Samuel multiplicities $c(I)$, which are also known to be invariant up to the integral closure of I , see [7, Proposition 2.7].

A hyperplane

$$H = \{v \in \mathbb{R}^d \mid \langle v, a \rangle = b\} \quad (\text{with } a \in \mathbb{R}_{\geq 0}^d, b \in \mathbb{R})$$

is called a *supporting hyperplane* of the Newton polyhedron $\text{NP}(I)$ if

$$\text{NP}(I) \subset H^+ = \{v \in \mathbb{R}^d \mid \langle v, a \rangle \geq b\} \text{ and } \text{NP}(I) \cap H \neq \emptyset.$$

A subset $F \subset \text{NP}(I)$ is called a *proper face* of $\text{NP}(I)$ if there exists a supporting hyperplane H of $\text{NP}(I)$ such that $F = \text{NP}(I) \cap H$. The boundary of $\text{NP}(I)$ is a set of faces of

dimension $d - 1$, called *facets* of $\text{NP}(I)$, some of them may be compact.

The zero-dimensional faces are called *vertices* or *extreme points* of $\text{NP}(I)$. We shall denote the set of vertices by $\text{vert}(I)$. Note that the monomials corresponding to the points in $\text{vert}(I)$ are part of the set of minimal generators of I , so by renumbering we will assume that

$$\text{vert}(I) = \{v_1, \dots, v_s\} \text{ with some } s \leq r,$$

hence

$$\text{NP}(I) = \text{conv}(\{v_1, \dots, v_r\}) + \mathbb{R}_{\geq 0}^d = \text{conv}(\{v_1, \dots, v_s\}) + \mathbb{R}_{\geq 0}^d.$$

The monomials corresponding to the points in $\text{vert}(I)$ generate the unique minimal monomial reduction ideal of I , see [16, Proposition 2.1].

Any face F can be described using its vertices and infinite-directions. Let e_j denote the unit vector with non-zero j th component, let H be a supporting hyperplane such that $F = \text{NP}(I) \cap H$ and let a be a normal vector to H . We call the coordinate direction e_j an *infinite-direction* of F if the j th component $a(j)$ of a is zero. If v_1, \dots, v_s are the vertices of F , then

$$F = \text{conv}(\{v_1, \dots, v_s\}) + \sum_{j:a(j)=0} \mathbb{R}_{\geq 0} e_j.$$

Often we shall write simply $v_1 \dots v_s$ instead of $\text{conv}(\{v_1, \dots, v_s\})$. Of course, the compact or bounded faces are precisely those that do not have infinite-directions e_j .

By the Minkowski-Weyl Theorem for convex polyhedra, there are uniquely determined finitely many closed half spaces

$$\begin{aligned} H_i^+ &= \{v \in \mathbb{R}^d \mid \langle v, a_i \rangle \geq b_i\} \text{ (with } a_i \in \mathbb{Z}_{\geq 0}^d, b_i \in \mathbb{Z}_{\geq 0}), \\ &i = 1, \dots, t, \end{aligned}$$

such that

$$\text{NP}(I) = H_1^+ \cap \dots \cap H_t^+.$$

Then $F_i := H_i \cap \text{NP}(I)$, $i = 1, \dots, t$, are the facets of $\text{NP}(I)$. We will assume that H_1, \dots, H_u are the hyperplanes corresponding to the unbounded facets and that H_{u+1}, \dots, H_t are those corresponding to the compact facets.

To each bounded facet $F = \text{conv}(\{v_{i_1}, \dots, v_{i_s}\})$ of $\text{NP}(I)$ we associate the polytope (or pyramid)

$$\hat{F} := \text{conv}(0, F) = \text{conv}(\{0, v_{i_1}, \dots, v_{i_s}\})$$

and denote by $\text{vol}_d(\hat{F})$ its d -dimensional volume and by

$$\text{Vol}_d(\hat{F}) := d! \text{vol}_d(\hat{F})$$

its *normalized volume*.

The normalized volumes of pyramids over projections of bounded faces of $\text{NP}(I)$ play a crucial role in our conjectures. Since it was known that $c_0(I)$ equals the sum of the normalized d -dimensional volumes of the pyramids over the bounded facets of $\text{NP}(I)$, our guess was that $c_{d-(k+1)}(I)$ should be a sum of $(k+1)$ -dimensional volumes coming from the bounded faces F^k of dimension k . We succeeded in proving this for $k=0$ by projecting the vertices of $\text{NP}(I)$ on the

174
175
176
177
178
179
180
181
182
183
184
185
186
187
188
189
190
191
192
193
194
195
196
197
198
199
200
201
202
203
204
205
206
207
208
209
210
211
212
213
214
215
216
217
218
219
220
221
222
223
224
225
226
227
228
229
230
231
232

coordinate axes, see Theorem 2. Thus, in order to obtain $c_{d-(k+1)}(I)$, we tried to sum up the normalized $(k+1)$ -dimensional volumes of the pyramids over the projections of the bounded faces F^k of $\text{NP}(I)$ on coordinate $(k+1)$ -planes. This did not work well, and by [5, Section 2.2] we realized that one should consider only projections along the infinite-directions of facets F^{d-1} that contain F^k . Then we refined our guess by computing many examples. To formulate our conjectures, we proceed as follows.

We call a facet $F \subset \text{NP}(I)$ an *h-unbounded facet* if the normal vector a to its supporting hyperplane has at least $h > 0$ coordinates $a(j)$ which are zero, that is, if the facet has at least h infinite-directions e_j .

Let $\mathcal{F}(k)$ be the set of all $(d-(k+1))$ -unbounded facets containing at least one k -dimensional compact face F^k , $0 \leq k \leq d-2$. We define $\mathcal{F}(d-1)$ to be the set of all compact or bounded facets of $\text{NP}(I)$.

If $F^{d-1} \in \mathcal{F}(k)$ and F^k is a k -dimensional compact face contained in F^{d-1} , then we associate to the pair (F^k, F^{d-1}) a $(k+1)$ -dimensional normalized volume $\text{Vol}(F^k, F^{d-1})$ as follows. Let $L \subset \{1, \dots, d\}$ be such that $\{e_\ell : \ell \in L\}$ is the set of all infinite-directions of F^{d-1} and let M_1, \dots, M_q be all subsets of L consisting of exactly $d-(k+1)$ infinite-directions. For $i = 1, \dots, q$, let

$$\pi_i : \mathbb{R}^d \rightarrow \sum_{1 \leq j \leq d, j \notin M_i} \mathbb{R}e_j \cong \mathbb{R}^{k+1}$$

be the orthogonal projection which removes from $v \in \mathbb{R}^d$ the coordinates $v(m)$ with $m \in M_i$. Then $\pi_i(F^k)$ is a polytope of dimension at most k . By renumbering, assume that $\dim(\pi_i(F^k)) = k$ for $1 \leq i \leq p$ and $\dim(\pi_i(F^k)) < k$ for $p+1 \leq i \leq q$.



The volume associated to the pair (F^k, F^{d-1}) is

$$\text{Vol}(F^k, F^{d-1}) := \min_{1 \leq i \leq p} \text{Vol}_{k+1}(\text{conv}(\{0, \pi_i(F^k)\})). \quad (3-1)$$

Conjecture 1. For each $k = 0, \dots, d-1$, the generalized Samuel multiplicity of a monomial ideal I is

$$c_{d-(k+1)}(I) = \sum_{F^{d-1} \in \mathcal{F}(k)} \min_{F^k} \{\text{Vol}(F^k, F^{d-1})\}, \quad (3-2)$$

where the minimum is taken over all compact faces F^k of $\text{NP}(I)$ that are contained in the facet F^{d-1} .

In the extremal cases $k = d-1$ and $k = 0$ the formula (3.2) can be simplified.

The case $k = d-1$. Since $\mathcal{F}(d-1)$ is the set of compact facets of $\text{NP}(I)$, $F^{d-1} \in \mathcal{F}(d-1)$ does not have infinite-directions. Hence L above is empty, $q = 1$, $M_1 = \emptyset$ and π_1 is the identity map on \mathbb{R}^d . The only $(d-1)$ -dimensional compact face contained in F^{d-1} is F^{d-1} itself and

$$\begin{aligned} \text{Vol}(F^{d-1}, F^{d-1}) &:= \text{Vol}_d(\text{conv}(\{0, \pi_1(F^{d-1})\})) \\ &= \text{Vol}_d(\text{conv}(\{0, F^{d-1}\})). \end{aligned}$$

Then the formula (3-2) reads

$$c_0(I) = \sum_{F^{d-1} \in \mathcal{F}(d-1)} \text{Vol}_d(\text{conv}(\{0, F^{d-1}\})). \quad (3-3)$$

The case $k = 0$. At first we describe $\mathcal{F}(0)$.

Proposition 2. Let $I \subset K[x_1, \dots, x_d] = K[\mathbf{x}]$ be an ideal generated by the monomials $\mathbf{x}^{v_1}, \dots, \mathbf{x}^{v_r}$. For $j = 1, \dots, d$, set $m_j := \min\{v_1(j), \dots, v_r(j)\}$ and

$$F_j := \text{conv}(\{v \in \text{vert}(I) \mid v(j) = m_j\}) + \sum_{1 \leq i \leq d, i \neq j} \mathbb{R}_{\geq 0} e_i.$$

Then $\mathcal{F}(0) = \{F_1, \dots, F_d\}$.

Proof. Since each $v \in \text{NP}(I)$ is the sum of a convex combination of the vertices v_1, \dots, v_s of $\text{NP}(I)$ and of some $w \in \mathbb{R}_{\geq 0}^d$, we have

$$v(j) \geq \min\{v_1(j), \dots, v_s(j)\} + w(j) \geq \min\{v_1(j), \dots, v_s(j)\},$$

hence

$$m_j := \min\{v_1(j), \dots, v_r(j)\} = \min\{v_1(j), \dots, v_s(j)\} = \min_{v \in \text{NP}(I)} \{v(j)\}.$$

It follows that F_1, \dots, F_d are precisely the $(d-1)$ -unbounded facets of $\text{NP}(I)$, that is, $\mathcal{F}(0) = \{F_1, \dots, F_d\}$. \square

By the preceding proposition, for $k = 0$ the formula (3-2) reads

$$c_{d-1}(I) = \sum_{j=1}^d \min_v \{\text{Vol}(v, F_j)\}, \quad (3-4)$$

where the minimum is taken over all vertices v of $\text{NP}(I)$ that are contained in the facet F_j . In order to compute $\text{Vol}(v, F_j)$, note that each F_j has $d-1$ infinite-directions, more precisely, $L = \{1, \dots, \hat{j}, \dots, d\}$, hence $q = 1$, $L = M_1$, and $\pi_1 : \mathbb{R}^d \rightarrow \mathbb{R}e_j$ sends each $v \in F_j$ to its j th coordinate $v(j) = m_j$. It follows that $\text{Vol}(v, F_j) = \text{Vol}_1(\text{conv}(\{0, \pi_1(v)\})) = v(j) = m_j$ for each vertex v of $\text{NP}(I)$ that is contained in F_j , and no minimum has to be taken in (3-4). Thus the formula of Conjecture 1 becomes

$$c_{d-1}(I) = m_1 + \dots + m_d. \quad (3-5)$$

Conjecture 2. With the notation of Proposition 1, for each $k = 0, \dots, d-1$, there is a one-to-one correspondence between the non-zero $c_{d-(k+1)}(T/Q_i)$ and the non-zero summands $\min_{F^k} \{\text{Vol}(F^k, F^{d-1})\}$ in the formula of Conjecture 1 such that the corresponding numbers are equal.

In particular, the number of compact facets of $\text{NP}(I)$ is equal to the number of d -dimensional associated prime ideals of T that contain $\mathfrak{m} = (x_1, \dots, x_d)\mathbb{R}$.

Moreover, if $\text{Vol}(F^k, F^{d-1}) \neq 0$ contributes to $c_{d-(k+1)}(I)$ and can be obtained by more than one projection \mathfrak{p}_α , then it is a movable contribution.

Note that in general, if K is algebraically closed and

$$T = G_{\mathfrak{m}}(G_I(\mathbb{R})) \cong K[x_1, \dots, x_d, y_1, \dots, y_r]/\mathfrak{n},$$

then the bigraded ideal \mathfrak{n} is a binomial but not a monomial ideal, see [8, Corollary 1.9].

Our conjectures are confirmed by many examples, but so far we do not have a proof except for Conjecture 1 in the extremal cases $k = 0$ (formula (3-3)) and $k = d-1$ (formula (3-5)), as it is stated in the following two theorems.

Theorem 1. (Jeffries and Montaña [13, Theorem 3.2]). If $I \subset K[x_1, \dots, x_d]$ is a monomial ideal and F_{r+1}, \dots, F_t

are the compact facets of the Newton polyhedron $\text{NP}(I)$, then

$$c_0(I) = \sum_{i=r+1}^t d! \text{vol}(\hat{F}_i) = \sum_{i=r+1}^t \text{Vol}(\hat{F}_i).$$

Theorem 2. Let I be a monomial ideal in $R = K[x_1, \dots, x_d] = K[\mathbf{x}]$ generated by $\mathbf{x}^{v_1}, \dots, \mathbf{x}^{v_r}$ and $m_j = \min\{v_1(j), \dots, v_r(j)\}, j = 1, \dots, d$. Then

$$c_{d-1}(I) = m_1 + \dots + m_d.$$

Proof. By [3, Proposition 2.3], $c_{d-1}(I) \neq 0$ if and only if $\dim R/I = d-1$. If $\dim R/I < d-1$, then none of the variables x_j appears in all monomials generating I , hence $m_j = 0$ for all j , and the result is true. If $\dim R/I = d-1$, then again by [3, loc. cit.],

$$c_{d-1}(I) = \sum_P e(IR_P) \cdot e(R/P),$$

where P runs through all $(d-1)$ -dimensional associated prime ideals of R/I , that is, prime ideals of the form (x_j) for some j . Therefore $IR_P = (x_j^{m_j})R_P$ and $e(IR_P) = m_j$. The $(d-1)$ -dimensional part of the primary decomposition of I is $(x_1^{m_1}) \cap (x_2^{m_2}) \cap \dots \cap (x_d^{m_d})$, which is of degree $m_1 + \dots + m_d$. \square

Corollary 3. Let $I \subset K[x_1, x_2]$ be a monomial ideal generated by $\mathbf{x}^{v_1}, \dots, \mathbf{x}^{v_r}$. We assume that v_1, \dots, v_s ($1 \leq s \leq r$) are the vertices of the Newton polyhedron $\text{NP}(I)$ numbered such that $v_1(1) > \dots > v_s(1)$, hence $v_1(2) < \dots < v_s(2)$. Then the set of unbounded facets of $\text{NP}(I)$ is

$$\mathcal{F}(0) = \{F_1 = v_s + \mathbb{R}_{\geq 0} e_2, F_2 = v_1 + \mathbb{R}_{\geq 0} e_1\},$$

the set of bounded facets of $\text{NP}(I)$ is

$$\mathcal{F}(1) = \{v_1 v_2, v_2 v_3, \dots, v_{s-1} v_s\} (= \emptyset \text{ if } s = 1),$$

and the generalized Samuel multiplicities are

$$c_0(I) = \det \begin{pmatrix} v_1 \\ v_2 \end{pmatrix} + \dots + \det \begin{pmatrix} v_{s-1} \\ v_s \end{pmatrix},$$

$$c_1(I) = v_1(2) + v_s(1), c_2 = 0.$$

Proof. The corollary follows immediately from Proposition 2, Theorem 1, Theorem 2 and [3, Proposition 2.3 (i)]. \square

4. Examples

We illustrate the theorems and the conjecture by examples of monomial ideals $I \subset R = K[x_1, \dots, x_d]$, K an arbitrary field. We set $\mathfrak{m} := (x_1, \dots, x_d)R$ and $T := G_{\mathfrak{m}}(G_I(R))$. All the examples will show a close relation between the summands in the formula of Conjecture 1 and the highest dimensional primary components of T and confirm Conjecture 2.

In our first two examples we consider monomial ideals in polynomial rings of dimension two. Note that Conjecture 1

holds in this case (formulas (3-3) and (3-5)), see the Theorems 1 and 2 and Corollary 3.

Example 1 (Figure 1). We begin with the simplest case of a monomial ideal generated by one monomial in two variables in order to illustrate Corollary 3 if the Newton polyhedron has only one vertex.

Let $I = (x^3 y^2) \subset R = K[x, y]$. We have

$$c(I) = (c_0(I), c_1(I), c_2(I)) = (0, 5, 0) = 2 \cdot (0, 1, 0) + 3 \cdot (0, 1, 0),$$

where the summands are the contributions of the components of the bigraded ring $G_{\mathfrak{m}}(G_I(R))$, see Proposition 1.

The Newton polyhedron $\text{NP}(I)$ has only one vertex $v = (3, 2)$ and two (unbounded) facets $F_1 = v + \mathbb{R}_{\geq 0} e_2$ and $F_2 = v + \mathbb{R}_{\geq 0} e_1$ (see Figure 1), hence $\mathcal{F}(1) = \emptyset$ and $c_0(I) = 0$. We have $\mathcal{F}(0) = \{F_1, F_2\}$ and $\text{Vol}(v, F_1) = 3$ and $\text{Vol}(v, F_2) = 2$, hence $c_1(I) = 5$.

Example 2 (Figure 2). This example is to illustrate Corollary 3 in the case of two and more vertices. The vertices are numbered as in the corollary.

Let $I = (x^6 y, x^4 y^2, x^2 y^5, x^3 y^4) \subset R = K[x, y]$. We have

$$c(I) = (c_0(I), c_1(I), c_2(I)) = (24, 3, 0) = 16 \cdot (1, 0, 0) + 8 \cdot (1, 0, 0) + 2 \cdot (0, 1, 0) + (0, 1, 0),$$

where the summands are the contributions of the components of the bigraded ring $G_{\mathfrak{m}}(G_I(R))$, see Proposition 1.

The Newton polyhedron $\text{NP}(I)$ has three vertices $v_1 = (6, 1), v_2 = (4, 2), v_3 = (2, 5)$, two unbounded facets $F_1 = v_3 + \mathbb{R}_{\geq 0} e_2, F_2 = v_1 + \mathbb{R}_{\geq 0} e_1$ and two bounded facets: the line segments $F_3 = \text{conv}(v_1, v_2), F_4 = \text{conv}(v_2, v_3)$ (see Figure 2), hence $\mathcal{F}(1) = \{F_3, F_4\}$ and

$$c_0(I) = \text{Vol}(\text{conv}(0, F_3)) + \text{Vol}(\text{conv}(0, F_4)) = \begin{vmatrix} 6 & 1 \\ 4 & 2 \end{vmatrix} + \begin{vmatrix} 4 & 2 \\ 2 & 5 \end{vmatrix} = 8 + 16.$$

We have $\mathcal{F}(0) = \{F_1, F_2\}$ and

$$c_1(I) = \text{Vol}(v_3, F_1) + \text{Vol}(v_1, F_2) = 1 + 2 = 3.$$

Example 3 (Figures 3-5). The purpose of this example is twofold. It shows that there can be compact faces of $\text{NP}(I)$ that do not contribute to the generalized Samuel multiplicity $c(I)$. Furthermore it aims to discuss a movable contribution (to $c_1(I)$). In this example, because of the movable contribution, the number of the highest dimensional components of T is one less than the number of summands in the conjectured formula (3-2).

Let $I = (x^2 y, x^2 z, x y^2, x z^2) \subset K[x, y, z]$. By a computer computation (using [1]) we have

$$c(I) = (c_0(I), c_1(I), c_2(I), c_3(I)) = (9, 3, 1, 0) = 3 \cdot (3, 0, 0, 0) + (0, 1, 0, 0) + (0, 2, 1, 0),$$

where the summands are the contributions of the highest dimensional components of the bigraded ring T , see Proposition 1. The contribution 2 in the last vector is a

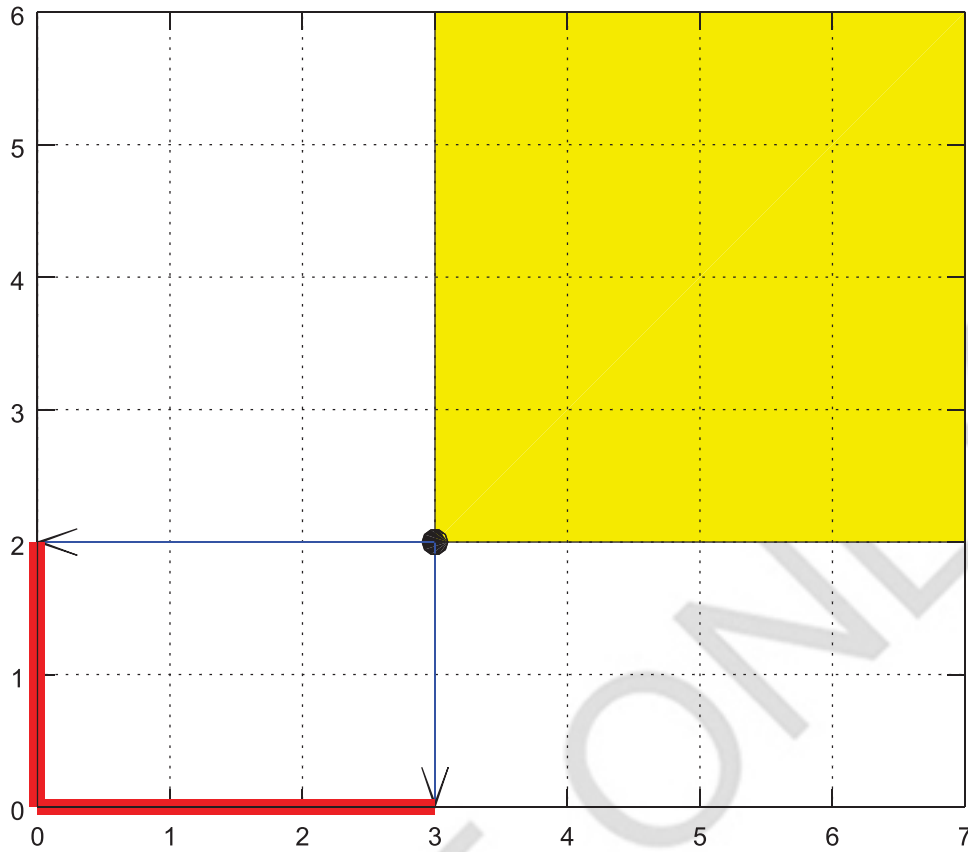

Figure 1. Projection along the infinite-directions of the facets gives $c_1(I)$, which is the red distance.

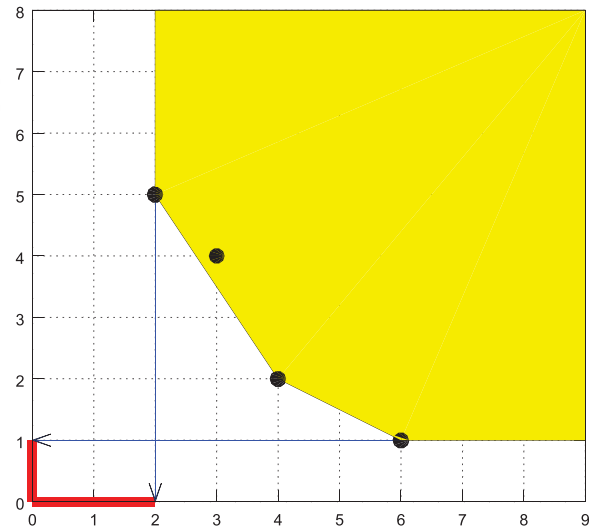
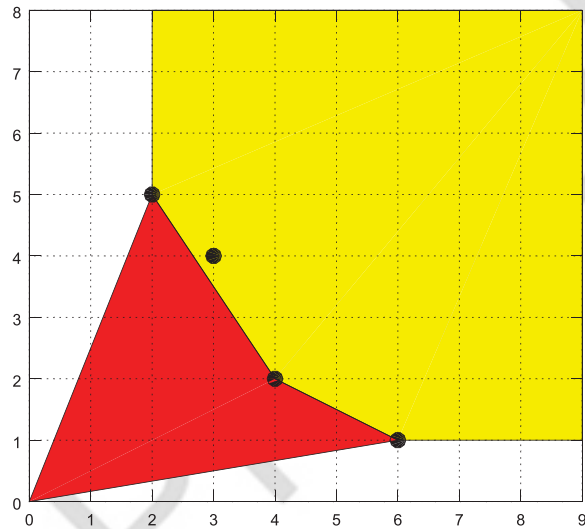

Figure 2. The red area is $c_0(I)/2$, the red distance $c_1(I)$.

movable contribution to $c_1(I)$. This can be read off also from the Newton polyhedron $NP(I)$, see Figure 5.

According to the program Germenes [14], the compact faces of $NP(I)$ are the vertices $v_1 = (2, 1, 0)$, $v_2 = (2, 0, 1)$, $v_3 = (1, 2, 0)$, $v_4 = (1, 0, 2)$, the line segments $v_1v_2, v_1v_3, v_2v_4, v_3v_4$ and the quadrilateral facet $v_1v_2v_4v_3$. The unbounded facets are

$$F_1 = v_3v_4 + \mathbb{R}_{\geq 0} e_2 + \mathbb{R}_{\geq 0} e_3, \quad F_2 = v_2v_4 + \mathbb{R}_{\geq 0} e_1 + \mathbb{R}_{\geq 0} e_3,$$

$$F_3 = v_1v_3 + \mathbb{R}_{\geq 0} e_1 + \mathbb{R}_{\geq 0} e_2, \quad F_4 = v_1v_2 + \mathbb{R}_{\geq 0} e_1.$$

We observe that the set of bounded facets is $\mathcal{F}(2) = \{v_1v_2v_4v_3\}$ and

$$c_0(I) = \text{Vol}(\text{conv}(0, v_1, v_2, v_4, v_3)) = \begin{vmatrix} 2 & 1 & 0 \\ 1 & 2 & 0 \\ 2 & 0 & 1 \end{vmatrix} + \begin{vmatrix} 2 & 0 & 1 \\ 1 & 2 & 0 \\ 1 & 0 & 2 \end{vmatrix}$$

$$= 3 + 6 = 9,$$

see Figure 4.

The set of 1-unbounded facets that contain a compact one-dimensional face is $\mathcal{F}(1) = \{F_1, F_2, F_3, F_4\}$, and we have

$$\text{Vol}(v_1v_2, F_4) = \begin{vmatrix} 1 & 0 \\ 0 & 1 \end{vmatrix} = 1,$$

528
529
530
531
532
533
534
535
536
537
538
539
540
541
542
543
544
545
546
547
548
549
550
551
552
553
554
555
556
557
558
559
560
561
562
563
564
565
566
567
568
569
570
571
572
573
574
575
576
577
578
579
580
581
582
583
584
585
586

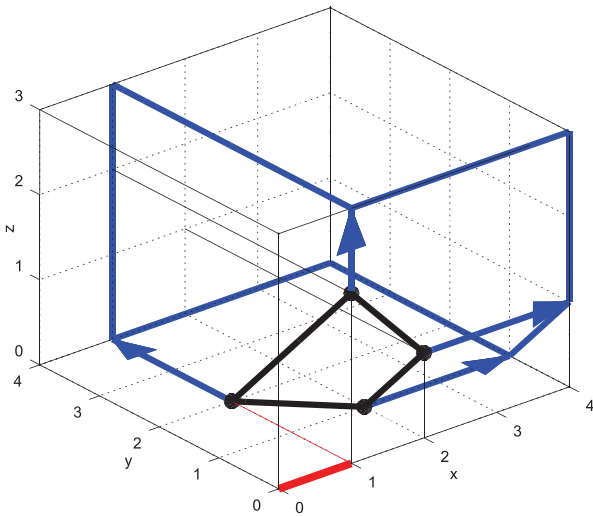
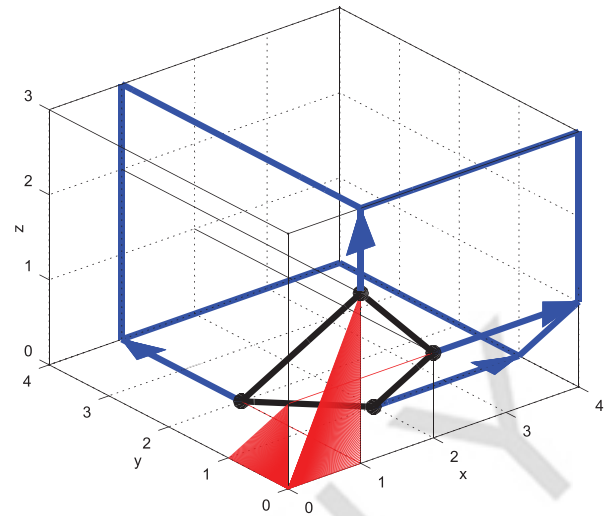

Figure 3. Infinite-directions (blue arrows) of the unbounded facets, $c_2(I)$ (red distance) and $c_1(I)/2$ (red area).



$$c_2(I) = \min\{\text{Vol}(v_3, F_1), \text{Vol}(v_4, F_1)\} + \text{Vol}(v_4, F_2) + \min\{\text{Vol}(v_1, F_3), \text{Vol}(v_3, F_3)\} = 1 + 0 + 0 = 1.$$

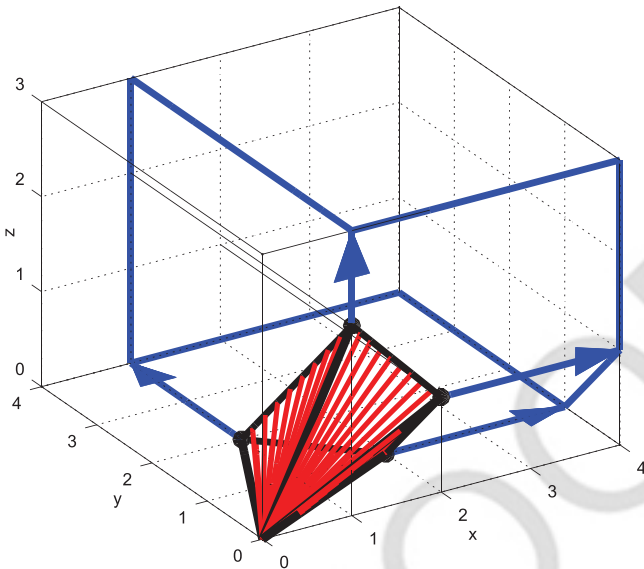

Figure 4. The volume of the red pyramid is $c_0(I)/6$.

$$\text{Vol}(v_1 v_3, F_3) = \min \left\{ \left| \begin{array}{cc|cc} 1 & 0 & 2 & 0 \\ 2 & 0 & 1 & 0 \end{array} \right| \right\} = 0,$$

$$\text{Vol}(v_2 v_4, F_2) = \min \left\{ \left| \begin{array}{cc|cc} 0 & 1 & 2 & 0 \\ 0 & 2 & 1 & 0 \end{array} \right| \right\} = 0,$$

$$\text{Vol}(v_3 v_4, F_1) = \min \left\{ \left| \begin{array}{cc|cc} 1 & 0 & 1 & 0 \\ 1 & 2 & 1 & 2 \end{array} \right| \right\} = 2$$

(the last minimum is given by two different projections and is a movable contribution, see Figure 5), hence

$$\begin{aligned} c_1(I) &= \text{Vol}(v_1 v_2, F_4) + \text{Vol}(v_1 v_3, F_3) + \text{Vol}(v_2 v_4, F_2) \\ &\quad + \text{Vol}(v_3 v_4, F_1) \\ &= 1 + 0 + 0 + 2 = 3. \end{aligned}$$

The set of 2-unbounded facets is $\mathcal{F}(0) = \{F_1, F_2, F_3\}$. We have $\text{Vol}(v_3, F_1) = 1, \text{Vol}(v_4, F_1) = 1, \text{Vol}(v_4, F_2) = 0, \text{Vol}(v_1, F_3) = 0, \text{Vol}(v_3, F_3) = 0$, hence

Example 4 (Figure 6). Here we give a monomial ideal I such that its Newton polyhedron has compact edges that do not lie on any 1-unbounded facet and therefore, according to Conjecture 1, have not to be taken into account in order to compute $c_1(I)$.

Let $I = (xy^4z^5, x^2y^5z^2, xy^5z^3, x^5yz^2, x^2yz^5, x^5y^2z) \subset K[x, y, z]$. By a computer computation we have

$$\begin{aligned} c(I) &= (c_0(I), c_1(I), c_2(I), c_3(I)) = (168, 26, 3, 0) = \\ &= 19 \cdot (1, 0, 0, 0) + 103 \cdot (1, 0, 0, 0) + 22 \cdot (1, 0, 0, 0) + \\ &\quad + 24 \cdot (1, 0, 0, 0) + 7 \cdot (0, 1, 0, 0) + (0, 3, 1, 0) + \\ &\quad + 8 \cdot (0, 1, 0, 0) + (0, 1, 0, 0) + 4 \cdot (0, 1, 0, 0) + \\ &\quad + 3 \cdot (0, 1, 0, 0) + (0, 0, 1, 0) + (0, 0, 1, 0), \end{aligned}$$

where the summands are the contributions of the highest dimensional components of the bigraded ring T , see Proposition 1. The contribution 3 in the sixth vector is a movable contribution to $c_1(I)$.

The program Germenes [14] gives the following description of the Newton polyhedron $\text{NP}(I)$. The compact faces of $\text{NP}(I)$ are the 6 vertices $v_1 = (1, 4, 5), v_2 = (2, 5, 2), v_3 = (1, 5, 3), v_4 = (5, 1, 2), v_5 = (2, 1, 5), v_6 = (5, 2, 1)$, the 9 line segments $v_4 v_6, v_2 v_6, v_5 v_6, v_4 v_5, v_3 v_6, v_3 v_2, v_3 v_5, v_1 v_5, v_1 v_3$ and the 4 triangles (bounded facets) $v_4 v_5 v_6, v_2 v_3 v_6, v_3 v_5 v_6, v_1 v_3 v_5$. There are 7 unbounded facets:

$$\begin{aligned} F_1 &= v_1 v_3 + \mathbb{R}_{\geq 0} e_2 + \mathbb{R}_{\geq 0} e_3, \quad F_2 = v_4 v_5 + \mathbb{R}_{\geq 0} e_1 \\ &\quad + \mathbb{R}_{\geq 0} e_3, \\ F_3 &= v_6 + \mathbb{R}_{\geq 0} e_1 + \mathbb{R}_{\geq 0} e_2, \quad F_4 = v_1 v_5 + \mathbb{R}_{\geq 0} e_3, \\ F_5 &= v_2 v_3 + \mathbb{R}_{\geq 0} e_2, \quad F_6 = v_2 v_6 + \mathbb{R}_{\geq 0} e_2, \\ F_7 &= v_4 v_6 + \mathbb{R}_{\geq 0} e_1. \end{aligned}$$

From the set of bounded facets $\mathcal{F}(2) = \{v_4 v_5 v_6, v_2 v_3 v_6, v_3 v_5 v_6, v_1 v_3 v_5\}$ we get

646
647
648
649
650
651
652
653
654
655
656
657
658
659
660
661
662
663
664
665
666
667
668
669
670
671
672
673
674
675
676
677
678
679
680
681
682
683
684
685
686
687
688
689
690
691
692
693
694
695
696
697
698
699
700
701
702
703
704

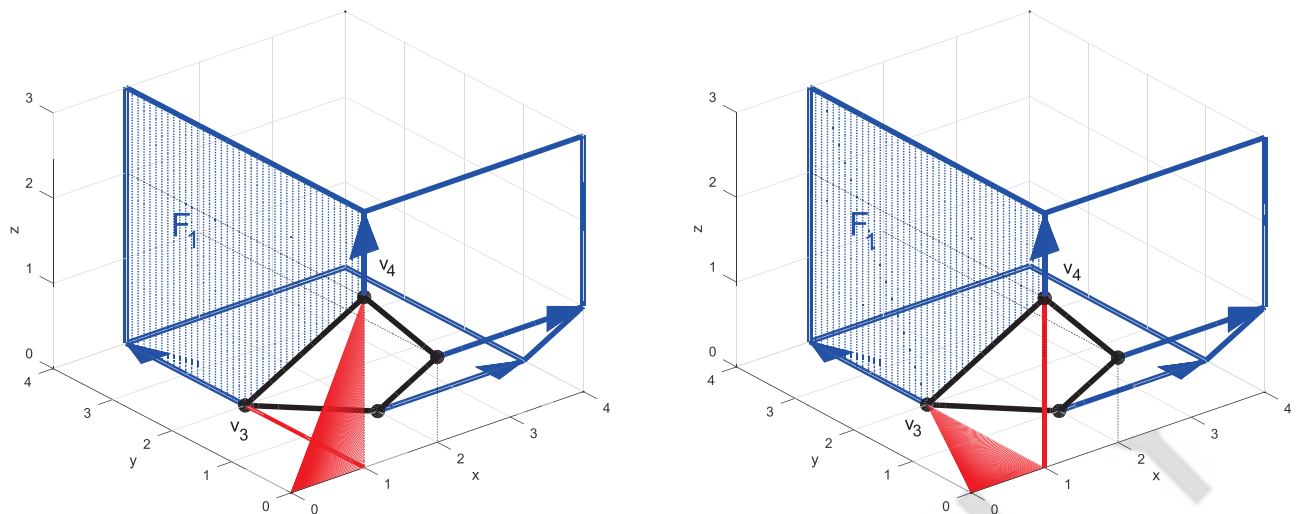

Figure 5. A movable contribution (to $c_1(I)/2$, red area) can be realized by at least two projections. Here the volume associated to the pair (v_3v_4, F_1) is obtained both by the projection of v_3v_4 along the y -axis and the z -axis, that is, along the two infinite-directions of F_1 .

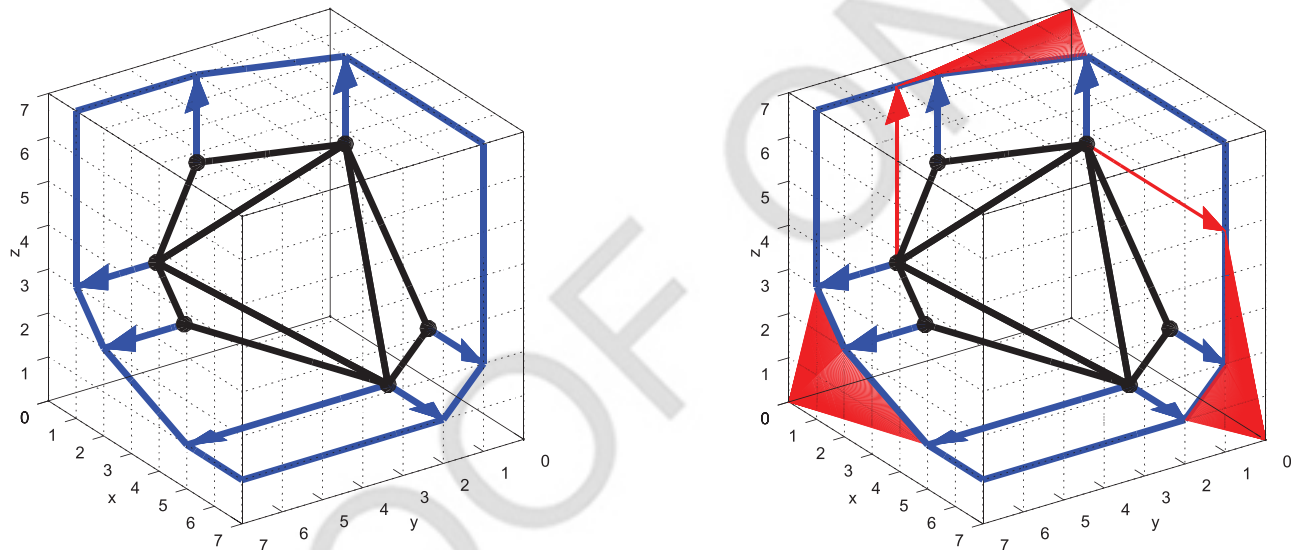

Figure 6. $NP(I)$ with compact (black) and unbounded (blue) facets; projections of compact edges along infinite-directions (blue arrows) give $c_1(I)/2$ (red area).

$$\begin{aligned}
 c_0(I) &= \text{Vol}(\text{conv}(0, v_4, v_5, v_6)) + \text{Vol}(\text{conv}(0, v_2, v_3, v_6)) + \\
 &\quad + \text{Vol}(\text{conv}(0, v_3, v_5, v_6)) + \text{Vol}(\text{conv}(0, v_1, v_3, v_5)) = \\
 &= \begin{vmatrix} 5 & 1 & 2 \\ 5 & 2 & 1 \\ 2 & 1 & 5 \end{vmatrix} + \begin{vmatrix} 2 & 5 & 2 \\ 1 & 5 & 3 \\ 5 & 2 & 1 \end{vmatrix} + \begin{vmatrix} 1 & 5 & 3 \\ 2 & 1 & 5 \\ 5 & 2 & 1 \end{vmatrix} + \begin{vmatrix} 1 & 4 & 5 \\ 2 & 1 & 5 \\ 1 & 5 & 3 \end{vmatrix} = \\
 &= 24 + 22 + 103 + 19 = 168.
 \end{aligned}$$

We have $\mathcal{F}(1) = \{F_1, F_2, F_4, F_5, F_6, F_7\}$ and

$$\begin{aligned}
 \text{Vol}(v_1v_3, F_1) &= \min\left\{\begin{vmatrix} 1 & 4 \\ 1 & 5 \end{vmatrix}, \begin{vmatrix} 1 & 3 \\ 1 & 5 \end{vmatrix}\right\} = \min\{1, 2\} = 1, \\
 \text{Vol}(v_4v_5, F_2) &= \min\left\{\begin{vmatrix} 5 & 1 \\ 2 & 1 \end{vmatrix}, \begin{vmatrix} 1 & 2 \\ 1 & 5 \end{vmatrix}\right\} = \min\{3, 3\} = 3
 \end{aligned}$$

(here the minimum is attained twice, that is, by two different projections which indicates a movable contribution),

$$\text{Vol}(v_1v_5, F_4) = \begin{vmatrix} 2 & 1 \\ 1 & 4 \end{vmatrix} = 7, \quad \text{Vol}(v_2v_3, F_5) = \begin{vmatrix} 2 & 2 \\ 1 & 3 \end{vmatrix} = 4,$$

$$\text{Vol}(v_2v_6, F_6) = \begin{vmatrix} 5 & 1 \\ 2 & 2 \end{vmatrix} = 8, \quad \text{Vol}(v_4v_6, F_7) = \begin{vmatrix} 2 & 1 \\ 1 & 2 \end{vmatrix} = 3,$$

hence

$$\begin{aligned}
 c_1(I) &= \text{Vol}(v_1v_3, F_1) + \text{Vol}(v_4v_5, F_2) + \text{Vol}(v_1v_5, F_4) + \\
 &\quad + \text{Vol}(v_2v_3, F_5) + \text{Vol}(v_2v_6, F_6) + \text{Vol}(v_4v_6, F_7) = \\
 &= 1 + 3 + 7 + 4 + 8 + 3 = 26.
 \end{aligned}$$

We observe that the compact 1-dimensional faces v_5v_6 , v_3v_6 , v_3v_5 , that is, the edges of the big triangle $v_3v_5v_6$, do not contribute to $c_1(I)$ since they lie on no 1-unbounded facet. Moreover, as in the previous example, there is a movable contribution, namely $\text{Vol}(v_4v_5, F_2) = 3$.

The set of 2-unbounded facets is $\mathcal{F}(0) = \{F_1, F_2, F_3\}$, and we have $\text{Vol}(v_1, F_1) = 1$, $\text{Vol}(v_3, F_1) = 1$, $\text{Vol}(v_4, F_2) = 1$, $\text{Vol}(v_5, F_2) = 1$, $\text{Vol}(v_6, F_3) = 1$, hence

$$\begin{aligned}
 c_2(I) &= \min\{\text{Vol}(v_1, F_1), \text{Vol}(v_3, F_1)\} \\
 &\quad + \min\{\text{Vol}(v_4, F_2), \text{Vol}(v_5, F_2)\} + \\
 &\quad + \text{Vol}(v_6, F_3) = 1 + 1 + 1 = 3.
 \end{aligned}$$

764
765
766
767
768
769
770
771
772
773
774
775
776
777
778
779
780
781
782
783
784
785
786
787
788
789
790
791
792
793
794
795
796
797
798
799
800
801
802
803
804
805
806
807
808
809
810
811
812
813
814
815
816
817
818
819
820
821
822

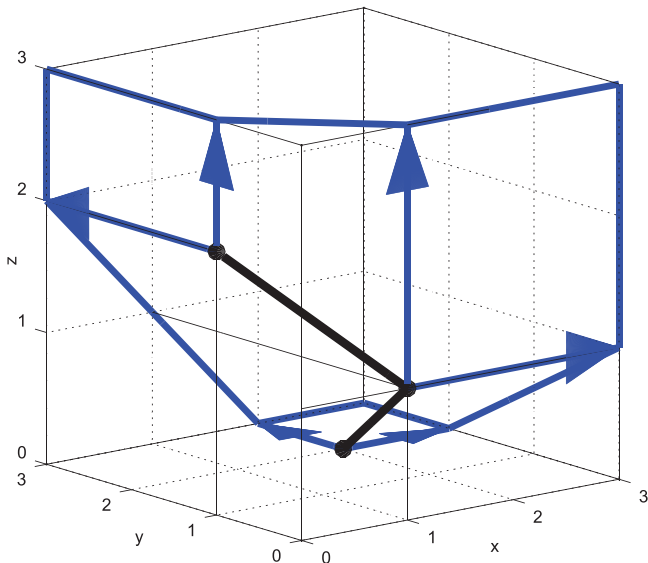

Figure 7. The triangle defined by 3 affinely independent vertices is not a compact facet.

Example 5 (Figure 7). The scope of this example is to give a monomial ideal in dimension three such that its Newton polyhedron has three affinely independent vertices v_1, v_2, v_3 , but its local Segre class is zero and thus not equal to the normalized volume of the simplex generated by the origin and v_1, v_2, v_3 as erroneously stated in [9, 4.2].

Let $I = (xz, x^2y^2, yz^2) \subset K[x, y, z]$. By a computer computation we have

$$c(I) = (c_0(I), c_1(I), c_2(I), c_3(I)) = (0, 7, 0, 0) = 2 \cdot (0, 1, 0, 0) + 2 \cdot (0, 1, 0, 0) + 2 \cdot (0, 1, 0, 0) + (0, 1, 0, 0),$$

where the summands are the contributions of the highest dimensional components of the bigraded ring T , see Proposition 1.

A computation with the program Germenes [14] shows that the compact faces of $\text{NP}(I)$ are the vertices $v_1 = (1, 0, 1), v_2 = (2, 2, 0), v_3 = (0, 1, 2)$ and the line segments v_1v_2, v_1v_3 . There are no compact facets, but 6 unbounded facets:

$$\begin{aligned} F_1 &= v_3 + \mathbb{R}_{\geq 0} e_2 + \mathbb{R}_{\geq 0} e_3, & F_2 &= v_1 + \mathbb{R}_{\geq 0} e_1 + \mathbb{R}_{\geq 0} e_3, \\ F_3 &= v_2 + \mathbb{R}_{\geq 0} e_1 + \mathbb{R}_{\geq 0} e_2, & F_4 &= v_1v_2 + \mathbb{R}_{\geq 0} e_1, \\ F_5 &= v_1v_3 + \mathbb{R}_{\geq 0} e_3, & F_6 &= v_1v_2v_3 + \mathbb{R}_{\geq 0} e_2. \end{aligned}$$

We observe that $\mathcal{F}(2) = \emptyset$, hence

$$c_0(I) = 0 \neq \text{Vol}_3(\text{conv}(\{0, v_1, v_2, v_3\})) = \begin{vmatrix} 1 & 0 & 1 \\ 2 & 2 & 0 \\ 0 & 1 & 2 \end{vmatrix} = 6.$$

This means that v_1, v_2, v_3 are affinely independent, but the local Segre class is zero and not equal to the normalized volume of the simplex generated by the origin and v_1, v_2, v_3 as claimed in [9, 4.2]. The reason is that the triangle $v_1v_2v_3$ is not a compact facet of $\text{NP}(I)$.

The set of 1-unbounded facets which contain a compact 1-dimensional face is $\mathcal{F}(1) = \{F_4, F_5, F_6\}$, and we have

$$\begin{aligned} \text{Vol}(v_1v_2, F_4) &= \begin{vmatrix} 2 & 0 \\ 0 & 1 \end{vmatrix} = 2, & \text{Vol}(v_1v_2, F_6) &= \begin{vmatrix} 2 & 0 \\ 1 & 1 \end{vmatrix} = 2, \\ \text{Vol}(v_1v_3, F_5) &= \begin{vmatrix} 1 & 0 \\ 0 & 1 \end{vmatrix} = 1, & \text{Vol}(v_1v_3, F_6) &= \begin{vmatrix} 1 & 1 \\ 0 & 2 \end{vmatrix} = 2, \end{aligned}$$

hence

$$\begin{aligned} c_1(I) &= \text{Vol}(v_1v_2, F_4) + \text{Vol}(v_1v_2, F_6) + \text{Vol}(v_1v_3, F_5) \\ &\quad + \text{Vol}(v_1v_3, F_6) \\ &= 2 + 2 + 1 + 2 = 7. \end{aligned}$$

The set of 2-unbounded facets is $\mathcal{F}(0) = \{F_1, F_2, F_3\}$ and we have

$$\text{Vol}(v_3, F_1) = 0, \quad \text{Vol}(v_1, F_2) = 0, \quad \text{Vol}(v_2, F_3) = 0,$$

hence $c_2(I) = 0$.

Example 6. With the notation of the paragraph before Conjecture 1, this example is to have pairs (F^k, F^{d-1}) such that $\dim(\pi_i(F^k)) < k$ for some of the projections π_i . In our example we have $k = 1, d = 4$, and the pairs (v_1v_2, F_2) and (v_1v_2, F_3) have the desired property.

Let $d = 4, I = (x_1^3x_2x_3x_4, x_1x_2x_3x_4^2)$. By a computer computation we have

$$\begin{aligned} c(I) &= (c_0(I), c_1(I), c_2(I), c_3(I), c_4(I)) = (0, 0, 7, 4, 0) = \\ &= 5 \cdot (0, 0, 1, 0, 0) + (0, 0, 1, 0, 0) + (0, 0, 1, 0, 0) + \\ &\quad + (0, 0, 0, 1, 0) + (0, 0, 0, 1, 0) + (0, 0, 0, 1, 0) + \\ &\quad + (0, 0, 0, 1, 0), \end{aligned}$$

where the summands are the contributions of the highest dimensional components of the bigraded ring T , see Proposition 1.

The compact faces of the Newton polyhedron $\text{NP}(I)$ are the vertices $v_1 = (3, 1, 1, 1), v_2 = (1, 1, 1, 2)$ and the line segment v_1v_2 . There are no compact facets, but 5 unbounded facets:

$$\begin{aligned} F_1 &= v_2 + \mathbb{R}_{\geq 0} e_2 + \mathbb{R}_{\geq 0} e_3 + \mathbb{R}_{\geq 0} e_4, \\ F_2 &= v_1v_2 + \mathbb{R}_{\geq 0} e_1 + \mathbb{R}_{\geq 0} e_3 + \mathbb{R}_{\geq 0} e_4, \\ F_3 &= v_1v_2 + \mathbb{R}_{\geq 0} e_1 + \mathbb{R}_{\geq 0} e_2 + \mathbb{R}_{\geq 0} e_4, \\ F_4 &= v_1 + \mathbb{R}_{\geq 0} e_1 + \mathbb{R}_{\geq 0} e_2 + \mathbb{R}_{\geq 0} e_3, \\ F_5 &= v_1v_2 + \mathbb{R}_{\geq 0} e_2 + \mathbb{R}_{\geq 0} e_3. \end{aligned}$$

Obviously $\mathcal{F}(3) = \mathcal{F}(2) = \emptyset$, hence $c_0(I) = c_1(I) = 0$. We have $\mathcal{F}(1) = \{F_2, F_3, F_5\}$ and

$$\begin{aligned} \text{Vol}(v_1v_2, F_2) &= \min \left\{ \begin{vmatrix} 3 & 1 \\ 1 & 1 \end{vmatrix}, \begin{vmatrix} 1 & 1 \\ 1 & 2 \end{vmatrix} \right\} = \min\{2, 1\} = 1, \\ \text{Vol}(v_1v_2, F_3) &= \min \left\{ \begin{vmatrix} 3 & 1 \\ 1 & 1 \end{vmatrix}, \begin{vmatrix} 1 & 1 \\ 1 & 2 \end{vmatrix} \right\} = \min\{2, 1\} = 1, \\ \text{Vol}(v_1v_2, F_5) &= \begin{vmatrix} 3 & 1 \\ 1 & 2 \end{vmatrix} = 5. \end{aligned}$$

We observe that in the computations of $\text{Vol}(v_1v_2, F_2)$ and $\text{Vol}(v_1v_2, F_3)$ the projection of the line segment v_1v_2 on the $\{x_2, x_3\}$ -plane gives the point $(1, 1)$ and must not be considered. We obtain

$$\begin{aligned} c_2(I) &= \text{Vol}(v_1v_2, F_2) + \text{Vol}(v_1v_2, F_3) + \text{Vol}(v_1v_2, F_5) \\ &= 1 + 1 + 5 = 7. \end{aligned}$$

The set of 3-unbounded facets is $\mathcal{F}(0) = \{F_1, F_2, F_3, F_4\}$, and we have

$$\begin{aligned} \text{Vol}(v_2, F_1) &= 1, & \text{Vol}(v_1, F_2) &= 1, & \text{Vol}(v_2, F_2) &= 1, \\ \text{Vol}(v_1, F_3) &= 1, & \text{Vol}(v_2, F_3) &= 1, & \text{Vol}(v_1, F_4) &= 1, \end{aligned}$$

hence

$$\begin{aligned} c_3(I) &= \text{Vol}(v_2, F_1) + \min\{\text{Vol}(v_1, F_2), \text{Vol}(v_2, F_2)\} + \\ &\quad + \min\{\text{Vol}(v_1, F_3), \text{Vol}(v_2, F_3)\} + \text{Vol}(v_1, F_4) = \\ &= 1 + 1 + 1 + 1 = 4. \end{aligned}$$

Example 7. This example is to show that in the formula of Conjecture 1 with $k > 0$ one needs to take the minimum over all compact faces F^k of $\text{NP}(I)$ that are contained in the facet F^{d-1} . In our example we have $d = 5$, $k = 1$ and three compact 1-dimensional faces lie on the same 3-unbounded facet F_3 or F_4 .

Let $d = 5$, $I = (x_1^3 x_2 x_3 x_4 x_5, x_1 x_2^2 x_3 x_4 x_5, x_1 x_2 x_3 x_4 x_5^5)$. By a computer computation we have

$$\begin{aligned} c(I) &= (c_0(I), c_1(I), c_2(I), c_3(I), c_4(I), c_5(I)) = (0, 0, 26, 6, 5, 0) = \\ &= 22 \cdot (0, 0, 1, 0, 0, 0) + 2 \cdot (0, 0, 1, 0, 0, 0) + 2 \cdot (0, 0, 1, 0, 0, 0) + \\ &\quad + 2 \cdot (0, 0, 0, 1, 0, 0) + (0, 0, 0, 1, 0, 0) + (0, 0, 0, 1, 0, 0) + \\ &\quad + (0, 0, 0, 1, 0, 0) + (0, 0, 0, 1, 0, 0) + (0, 0, 0, 0, 1, 0) + \\ &\quad + (0, 0, 0, 0, 1, 0) + (0, 0, 0, 0, 1, 0) + (0, 0, 0, 0, 1, 0) + \\ &\quad + (0, 0, 0, 0, 1, 0), \end{aligned}$$

where the summands are the contributions of the highest dimensional components of the bigraded ring T , see Proposition 1.

The program Germenes [14] shows that the compact faces of $\text{NP}(I)$ are the vertices $v_1 = (3, 1, 1, 1, 1)$, $v_2 = (1, 2, 1, 1, 1)$, $v_3 = (1, 1, 1, 1, 5)$, the line segments $v_1 v_2, v_1 v_3, v_2 v_3$ and the triangle $v_1 v_2 v_3$. The facets, all of them unbounded, are:

$$\begin{aligned} F_1 &= v_2 v_3 + \mathbb{R}_{\geq 0} e_2 + \mathbb{R}_{\geq 0} e_3 + \mathbb{R}_{\geq 0} e_4 + \mathbb{R}_{\geq 0} e_5, \\ F_2 &= v_1 v_3 + \mathbb{R}_{\geq 0} e_1 + \mathbb{R}_{\geq 0} e_3 + \mathbb{R}_{\geq 0} e_4 + \mathbb{R}_{\geq 0} e_5, \\ F_3 &= v_1 v_2 v_3 + \mathbb{R}_{\geq 0} e_1 + \mathbb{R}_{\geq 0} e_2 + \mathbb{R}_{\geq 0} e_4 + \mathbb{R}_{\geq 0} e_5, \\ F_4 &= v_1 v_2 v_3 + \mathbb{R}_{\geq 0} e_1 + \mathbb{R}_{\geq 0} e_2 + \mathbb{R}_{\geq 0} e_3 + \mathbb{R}_{\geq 0} e_5, \\ F_5 &= v_1 v_2 + \mathbb{R}_{\geq 0} e_1 + \mathbb{R}_{\geq 0} e_2 + \mathbb{R}_{\geq 0} e_3 + \mathbb{R}_{\geq 0} e_4, \\ F_6 &= v_1 v_2 v_3 + \mathbb{R}_{\geq 0} e_3 + \mathbb{R}_{\geq 0} e_4. \end{aligned}$$

Obviously $\mathcal{F}(4) = \mathcal{F}(3) = \emptyset$, hence $c_0(I) = c_1(I) = 0$. We have $\mathcal{F}(2) = \{F_3, F_4, F_6\}$ and

$$\begin{aligned} \text{Vol}(v_1 v_2 v_3, F_3) &= \text{Vol}(v_1 v_2 v_3, F_4) \\ &= \min \left\{ \begin{vmatrix} 3 & 1 & 1 \\ 1 & 2 & 1 \\ 1 & 1 & 1 \end{vmatrix}, \begin{vmatrix} 1 & 1 & 1 \\ 2 & 1 & 1 \\ 1 & 1 & 5 \end{vmatrix} \right\} = \\ &= \min\{2, 4\} = 2, \\ \text{Vol}(v_1 v_2 v_3, F_6) &= \begin{vmatrix} 3 & 1 & 1 \\ 1 & 2 & 1 \\ 1 & 1 & 5 \end{vmatrix} = 22. \end{aligned}$$

Observe that in the computations of $\text{Vol}(v_1 v_2 v_3, F_3)$ and $\text{Vol}(v_1 v_2 v_3, F_4)$ four projections of the compact triangle $v_1 v_2 v_3$ give a line segment and must not be considered. Summing up we get

$$\begin{aligned} c_2(I) &= \text{Vol}(v_1 v_2 v_3, F_3) + \text{Vol}(v_1 v_2 v_3, F_4) + \text{Vol}(v_1 v_2 v_3, F_6) \\ &= 2 + 2 + 22 = 26. \end{aligned}$$

The set of 3-unbounded facets containing 1-dimensional compact faces is $\mathcal{F}(1) = \{F_1, F_2, F_3, F_4, F_5\}$, and we have

$$\begin{aligned} \text{Vol}(v_2 v_3, F_1) &= \min \left\{ \begin{vmatrix} 1 & 1 \\ 1 & 2 \end{vmatrix}, \begin{vmatrix} 1 & 1 \\ 1 & 5 \end{vmatrix} \right\} = \min\{1, 4\} = 1, \\ \text{Vol}(v_1 v_3, F_2) &= \min \left\{ \begin{vmatrix} 3 & 1 \\ 1 & 1 \end{vmatrix}, \begin{vmatrix} 1 & 1 \\ 1 & 5 \end{vmatrix} \right\} = \min\{2, 4\} = 2, \\ \text{Vol}(v_1 v_2, F_3) &= \text{Vol}(v_1 v_2, F_4) = \min \left\{ \begin{vmatrix} 3 & 1 \\ 1 & 1 \end{vmatrix}, \begin{vmatrix} 2 & 1 \\ 1 & 1 \end{vmatrix} \right\} \\ &= \min\{2, 1\} = 1, \\ \text{Vol}(v_1 v_3, F_3) &= \text{Vol}(v_1 v_3, F_4) = \min \left\{ \begin{vmatrix} 3 & 1 \\ 1 & 1 \end{vmatrix}, \begin{vmatrix} 1 & 1 \\ 1 & 5 \end{vmatrix} \right\} \\ &= \min\{2, 4\} = 2, \\ \text{Vol}(v_2 v_3, F_3) &= \text{Vol}(v_2 v_3, F_4) = \min \left\{ \begin{vmatrix} 2 & 1 \\ 1 & 1 \end{vmatrix}, \begin{vmatrix} 1 & 1 \\ 1 & 5 \end{vmatrix} \right\} \\ &= \min\{1, 4\} = 1, \\ \text{Vol}(v_1 v_2, F_5) &= \min \left\{ \begin{vmatrix} 3 & 1 \\ 1 & 1 \end{vmatrix}, \begin{vmatrix} 2 & 1 \\ 1 & 1 \end{vmatrix} \right\} = \min\{2, 1\} = 1, \end{aligned}$$

hence

$$\begin{aligned} c_3(I) &= \text{Vol}(v_2 v_3, F_1) + \text{Vol}(v_1 v_3, F_2) + \\ &\quad + \min\{\text{Vol}(v_1 v_2, F_3), \text{Vol}(v_1 v_3, F_3), \text{Vol}(v_2 v_3, F_3)\} + \\ &\quad + \min\{\text{Vol}(v_1 v_2, F_4), \text{Vol}(v_1 v_3, F_4), \text{Vol}(v_2 v_3, F_4)\} + \\ &\quad + \text{Vol}(v_1 v_2, F_5) = 1 + 2 + 1 + 1 + 1 = 6. \end{aligned}$$

From the list of the facets we see that there are five 4-unbounded facets, precisely $\mathcal{F}(0) = \{F_1, F_2, F_3, F_4, F_5\}$ and we have

$$\begin{aligned} \text{Vol}(v_2, F_1) &= 1, & \text{Vol}(v_3, F_1) &= 1, & \text{Vol}(v_1, F_2) &= 1, \\ \text{Vol}(v_3, F_2) &= 1, & & & & \\ \text{Vol}(v_1, F_3) &= 1, & \text{Vol}(v_2, F_3) &= 1, & \text{Vol}(v_3, F_3) &= 1, \\ \text{Vol}(v_1, F_4) &= 1, & & & & \\ \text{Vol}(v_2, F_4) &= 1, & \text{Vol}(v_3, F_4) &= 1, & \text{Vol}(v_1, F_5) &= 1, \\ \text{Vol}(v_2, F_5) &= 1, & & & & \end{aligned}$$

$$\begin{aligned} c_4(I) &= \min\{\text{Vol}(v_2, F_1), \text{Vol}(v_3, F_1)\} + \min\{\text{Vol}(v_1, F_2), \\ &\quad \text{Vol}(v_3, F_2)\} + \\ &\quad + \min\{\text{Vol}(v_1, F_3), \text{Vol}(v_2, F_3), \text{Vol}(v_3, F_3)\} + \\ &\quad + \min\{\text{Vol}(v_1, F_4), \text{Vol}(v_2, F_4), \text{Vol}(v_3, F_4)\} + \\ &\quad + \min\{\text{Vol}(v_1, F_5), \text{Vol}(v_2, F_5)\} = 1 + 1 + 1 + 1 + 1 = 5. \end{aligned}$$

Acknowledgments

We are grateful to the referees, whose comments improved the presentation.

ORCID

Rüdiger Achilles  <http://orcid.org/0000-0003-0935-2697>
Mirella Manaresi  <http://orcid.org/0000-0003-2693-9641>

References

- 1059
1060
1061
1062
1063
1064
1065
1066
1067
1068
1069
1070
1071
1072
1073
1074
1075
1076
1077
1078
1079
1080
1081
1082
1083
1084
1085
1086
1087
1088
1089
1090
1091
1092
1093
1094
1095
1096
1097
1098
1099
1100
1101
1102
1103
1104
1105
1106
1107
1108
1109
1110
1111
1112
1113
1114
1115
1116
1117
- [1] Achilles, R, Aliffi, D. Segre, a script for the Reduce package Cali, Bologna, 1999–2017. Available at: <http://www.dm.unibo.it/achilles/segre/>
- [2] Achilles, R, Manaresi, M. (1993). Multiplicity for ideals of maximal analytic spread and intersection theory. *J. Math. Kyoto Univ.* 33(4): 1029–1578.
- [3] Achilles, R, Manaresi, M. (1997). Multiplicities of a bigraded ring and intersection theory. *Math. Ann.* 309(4): 573–591.
- [4] Achilles, R, Rams, S. (2001). Intersection numbers, Segre numbers and generalized Samuel multiplicities. *Arch. Math.* 77(5): 391–398.
- [5] Aluffi, P. (2016). Segre classes as integrals over polytopes. *J. Eur. Math. Soc.* 18(12): 2849–2863.
- [6] Bivià-Ausina, C. (2003). The analytic spread of monomial ideals. *Commun. Algebra.* 31(7): 3487–3496.
- [7] Ciupercă, C. (2003). A numerical characterization of the S_2 -ification of a Rees algebra. *J. Pure Appl. Algebra.* 178: 25–48.
- [8] Eisenbud, D, Sturmfels, B. (1996). Binomial ideals. *Duke Math. J.* 84(1): 1–45.
- [9] Guibert, G. (1999). Classe de Segre locale d'un idéal et frontières de Newton. *C. R. Acad. Sci. Paris Sér. I Math.* 329(4): 315–320.
- [10] Hearn, A. C. (1968). Reduce: A user-oriented interactive system for algebraic simplification. In: Klerer, M., Reinfelds, J., eds. *Interactive Systems for Experimental Applied Mathematics*. New York, NY: Academic Press, pp. 79–90.
- [11] Hearn, et al. REDUCE: A portable general-purpose computer algebras system. Available at: <https://reduce-algebra.sourceforge.io/>.
- [12] Huneke, C, Swanson, I. (2006). *Integral Closure of Ideals, Rings, and Modules*. London Mathematical Society Lecture Note Series, 336. Cambridge: Cambridge University Press.
- [13] Jeffries, J, Montaña, J. (2013). The j -multiplicity of monomial ideals. *Math. Res. Lett.* 20(4): 729–744.
- [14] Montesinos Amilibia, A. Germenes, a program for computing Newton polyhedra. Available at: <http://www.uv.es/montesin/>
- [15] Reid, L, Vitulli, M. A. (1999). The weak subintegral closure of a monomial ideal. *Commun. Algebra.* 27(11): 5649–5667.
- [16] Singla, P. (2007). Minimal monomial reductions and the reduced fiber ring of an extremal ideal. *Illinois J. Math.* 51(4): 1085–1102.
- [17] Teissier, B. (1988). Monômes, volumes et multiplicités. In *Introduction à la Théorie Des Singularités, Vol. II*. Travaux en Cours, 37. Paris: Hermann, pp. 127–141.
- [18] van der Waerden, B. L. (1929). On Hilbert's function, series of composition of ideals and a generalisation of the theorem of Bezout. *Proc. Roy. Acad. Amsterdam.* 31: 749–770.

1118
1119
1120
1121
1122
1123
1124
1125
1126
1127
1128
1129
1130
1131
1132
1133
1134
1135
1136
1137
1138
1139
1140
1141
1142
1143
1144
1145
1146
1147
1148
1149
1150
1151
1152
1153
1154
1155
1156
1157
1158
1159
1160
1161
1162
1163
1164
1165
1166
1167
1168
1169
1170
1171
1172
1173
1174
1175
1176