

This article has been accepted for publication in MNRAS © 2018 The Authors. Published by Oxford University Press on behalf of the Royal Astronomical Society. All rights reserved.

Deep learning based detection of cosmological diffuse radio sources

C. Gheller,¹★ F. Vazza^{2,3,4} and A. Bonafede^{2,3,4}

¹ETHZ-CSCS, Via Trevano 131, CH-6900, Lugano, Switzerland

²Dipartimento di Fisica e Astronomia, Via Gobetti 93/2, I-40131, Bologna, Italy

³Hamburger Sternwarte, Gojenbergsweg 112, D-21029 Hamburg, Germany

⁴INAF-Istituto di Radio Astronomia, Via Gobetti 101, Bologna, Italy

Accepted 2018 July 29. Received 2018 July 26; in original form 2018 April 11

ABSTRACT

In this paper we introduce a reliable, fully automated and fast algorithm to detect extended extragalactic radio sources (cluster of galaxies, filaments) in existing and forthcoming surveys (like LOFAR and SKA). The proposed solution is based on the adoption of a Deep Learning approach, more specifically a Convolutional Neural Network, that proved to perform outstandingly in the processing, recognition and classification of images. The challenge, in the case of radio interferometric data, is the presence of noise and the lack of a sufficiently large number of labelled images for the training. We have specifically addressed these problems and the resulting software, COSMODEEP, proved to be an accurate, efficient and effective solution for detecting very faint sources in the simulated radio images. We present the comparison with standard source finding techniques, and discuss advantages and limitations of our new approach.

Key words: methods: numerical – galaxies: clusters: general – intergalactic medium – large-scale structure of Universe.

1 INTRODUCTION

The challenge facing astronomers in the upcoming decade is not only scientific, but also technological. A flurry of complex data will be delivered by new telescopes such as SKA, LSST or CTA, and this will be difficult to manage with traditional approaches. Data will have to be stored in dedicated facilities, providing the necessary capacity at the highest performance. Corresponding data processing will have to be performed local to the data, exploiting available high-performance computing resources. Data reduction and imaging software tools will have to be adapted, if not completely re-designed, in order to efficiently run at scale. Fully automated pipelines will be a compelling requirement for effective software stacks as the richness and complexity of incoming data will inhibit human interaction and supervision.

In this work, we focus on radio imaging of extended and low surface brightness emission from the cosmic web (e.g. Brown 2011), which may become feasible thanks to the expected 10-fold improvement in instrument sensitivity. Such large-scale diffuse and faint emission is mostly associated with the extended distribution of synchrotron emitting electrons in the largest structures of the Universe, i.e. the gas structure around galaxy clusters and filaments. This is expected to appear as an elongated low surface brightness and flat spectrum radio emission [i.e. $\alpha \sim 1$, with α being the spectral index, linked to the source flux density S according to $S(\nu) \propto \nu^{-\alpha}$] tracing

structure formation shocks in cluster outskirts and around cosmic filaments (e.g. Vazza et al. 2015). Detecting this diffuse emission will be particularly important as it is expected to carry unique information on the origin of extragalactic magnetic fields (e.g. Vazza et al. 2017).

However, identifying the faint radio signal from cosmic filaments will be particularly challenging owing to the difficulty in detecting their gas component in any other wavelength, as well as due to the very large angular scale they typically probe (several degrees), which makes them increasingly more elusive at high radio frequencies. In addition, radio images obtained through interferometric observations are affected by several instrumental and environmental effects, which may increase the image noise well above the expected thermal noise threshold (e.g. radio interferometric interferences from the ground and from the sky, unstable ionospheric conditions, deconvolution artefacts). As some of these effects are direction-dependent and vary across the field of view, the final noise in the image is often non-uniform and of similar level to the signal from the real sources.

Our goal here is to develop a source finder tool tailored to detect faint and extended sources, with an accuracy comparable to that of the most sophisticated software available, for instance PYBDSF (see Section 5), a recent PYTHON-based tool designed for LOFAR, which is to our knowledge the most used in the field. We also require our tool to be flexible and easily extensible enough to handle different kinds of problems, for instance the analysis of multi-dimensional data, like radio data cubes. Furthermore, it has to run efficiently on large supercomputing systems, exploiting, in particular, parallelism

* E-mail: cgheller@cscs.ch

and accelerators, managing problems of ‘any’ size at high performance. Finally, it has to be fully automated, requiring no human intervention or control, and based on portable components, in order to be usable on any computing architecture.

In order to develop such data-processing methodology, we have explored the potential of Machine Learning, a branch of Artificial Intelligence already successfully used in astronomy (for a review see Ball & Brunner 2009; Kremer et al. 2017, and for recent applications see Barchi et al. 2017; Beck et al. 2018; Lucie-Smith et al. 2018; Rodriguez et al. 2018, Sullivan, Iliev & Dixon 2018). Among the various Machine Learning approaches, we have focused on Deep Learning, which provides outstanding performance for tasks relating to computer vision, text analysis, fragmentation, speech recognition (Lecun et al. 1998, Krizhevsky, Sutskever & Hinton 2012; Simonyan & Zisserman 2014; Szegedy et al. 2015; He et al. 2016; Garcia-Garcia et al. 2017), among others. Deep Learning has become increasingly popular in the last decade thanks to two concurrent factors: the availability of enough computing power to cope with complex, multi-layered neural networks, and the availability of enough data to perform the training. Recently, it has also been adopted in applications in astronomy and cosmology (see e.g. Aniyani & Thorat 2017; Gieseke et al. 2017; Nieto et al. 2017; Mahabal et al. 2017; Schmelzle et al. 2017; Abraham et al. 2018; Connor & van Leeuwen 2018; Hassan et al. 2018; Herbel et al. 2018; Lukic et al. 2018; Parks et al. 2018).

Out of the existing Deep Learning approaches, we have focused this work on Convolutional Neural Networks (CNN), which have proved to be both efficient and accurate in classifying images. The main advantages of CNNs are their high accuracy, their high computational performance and their suitability for a broad spectrum of applications. Training, involving basic linear algebra local operations, can be performed effectively on accelerated architectures exploiting, for instance, GPUs. The network can be efficiently decomposed to run on distributed, multi-processor systems (Shi & Chu 2017). Once trained, classification is a simple and fast task, and accuracy can range close to 100 per cent depending on the model, the task and the data set. Furthermore, by changing a few parameters and the input data, the same model can be trained for completely different tasks. Drawbacks are represented by the lack of flexibility of a trained model, a network being designed and trained on a specific kind of data input (e.g. 2000 × 2000 pixel grey-scale images), and the need for *large, labelled* training sets. The former obviously represents a serious concern in Astronomy due to the heterogeneity of the data products that can be delivered by different instruments, as well as due to the highly specialized format and resolution of output images from different telescopes.

The main challenge, however, is represented by the availability of sufficiently big data sets with pre-classified (labelled) images that can be used for the training. Tens of thousands of labelled images should be accessible in order to effectively train the network. Currently, few surveys of extragalactic objects have a large enough data set of labelled images, which makes any application of Deep Learning challenging. We have specifically addressed this problem by creating ‘mock’ observations, starting from the results produced by cosmological numerical simulations (see Section 3). This allows us to generate enough images to train the network. Having the full control of the training images, we had the capability to develop a labelling algorithm able to classify and label images without human supervision.

The CNN-based algorithm we present in this paper, called *COSMODEEP*, represents the first step towards a fully automated software

pipeline able to face the challenges posed by big, complex radio data. *COSMODEEP* can not only train the CNN and classify images, but also takes care of the preprocessing and labelling of the images used for the training. Hence it provides all the tools to develop an effective classification algorithm built on the top of a Deep Learning model.

The paper is organized as follows. The details of the *COSMODEEP* CNN are presented in Section 2. Section 3 focuses on the training data and how images are generated, labelled, and processed, in order to feed the CNN. Section 4 describes the tuning of the parameters of the CNN, the accuracy of the algorithm and its performance. The main results are presented in Section 5, with conclusions drawn in Section 6.

2 THE *COSMODEEP* CONVOLUTIONAL NEURAL NETWORK

Deep Learning builds on the top of neural networks, trying to exploit the inherent structure of the data. Deep Learning algorithms can take advantage of the spatial correlations of pixels in images, as in the case of CNNs, which are among the most successful techniques for image classification. We have adopted the CNN architecture for the implementation of *COSMODEEP*.

A CNN uses three basic ideas: local receptive fields, shared weights, and pooling. These are combined in a multi-layer architecture whose complexity (‘depth’) depends on the problem and on the desired accuracy. The first and the last layers are called *input* and *output layers*. All the others are called *hidden layers*. The CNN network designed for *COSMODEEP* is shown in Fig. 1.

Once input images are loaded in the input layer, each of them is scanned using a local receptive field, which is a small window (e.g. 3 × 3 or 5 × 5 pixels, in this paper the former is used) moving across all pixels in the image and calculating the *activation function*. In the case of our algorithm, this is a *ReLU* (Rectified Linear Units) function, which is one of the most successful choices of activation functions for Deep Learning (although several others are possible). It is defined as:

$$\sigma_{i,j} = \max\left(0, b_{i,j} + \sum_{l=1}^M \sum_{m=1}^M w_{l,m} a_{i+l-h, j+m-h}\right) \quad (1)$$

where M is the size of the window, $h = (M - 1)/2$, $a_{i,j}$ are the pixels, $w_{l,m}$ are the *weights* of the network and $b_{i,j}$ are the biases. For every pixel in the image we have the same set of shared $M \times M$ weights plus one additional shared bias. Weights and biases are randomly initialized. The resulting $\sigma_{i,j}$ compose the so-called *feature map* at the first hidden layer. Multiple feature maps can be calculated starting from different random initializations of the weights. This leads to a so-called *convolutional layer*. Convolutional layers are intended to identify the main features of objects contained in the image, and are usually followed by *pooling layers*. Pooling layers take each feature map output from the convolutional layer and calculate a new condensed feature map. It is common practice to use *max pooling* or *average pooling*, returning the maximum or the average value in a 2 × 2 input region. The resulting map has half size in each dimension. Pooling is separately applied to each single feature map. It is intended to get rid of the exact positional information of the identified features, focusing on the feature itself, wherever it is placed in the image.

Convolution and pooling are repeated taking the pooled feature maps at layer N-1 as an input, and producing a new lower resolution set of feature maps at layer N. The information extracted

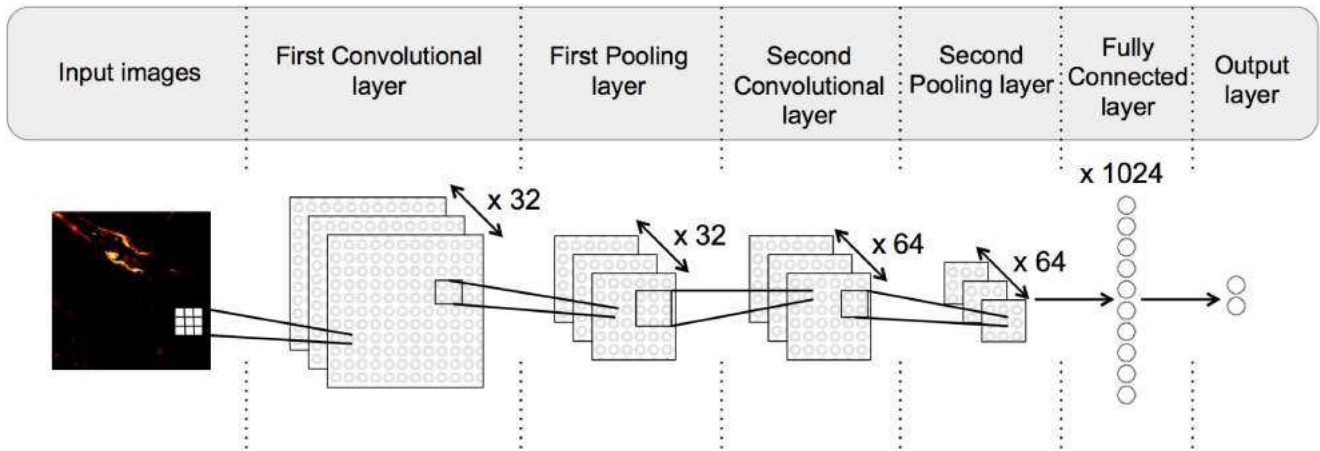

Figure 1. The COSMODEEP CNN architecture, accounting from one input, five hidden and one output layers.

from the images is progressively refined until the final hidden layer. This is usually a fully connected layer that combines and correlates the information refined in the previous layers. At the end, the output layer produces the final answer, which is compared to the correct answer known a priori. Correct answers are part of an image set classified through a labelling procedure performed independently from the CNN (our labelling methodology is described in Section 3.3.). The comparison allows estimating the error through a *cost function*. This error is minimized through an optimization process called *training* of the network. Optimization is achieved by calculating corrections to the weights moving along the gradient of the cost function, down towards a minimum value. Such an approach is called *gradient descent*. Once corrections have been calculated, they are back-propagated to all the layers of the network, correcting the weights up to the first hidden layer. Back propagation is not performed after each single image, but after a randomly selected sub-set of N training images has been processed and corresponding corrections accumulated. This sub-set of N images is called a *mini-batch*, and an optimal setting of N can accelerate the convergence of the algorithm towards the minimization of the error.

Gradient descent is an iterative process encompassing all the possible mini-batches in the data set. At each iteration the estimated corrections are weighted by the *learning rate* parameter. The learning rate controls how much the weights of the network are adjusted for each mini-batch, influencing the convergence and the accuracy of the algorithm. Small values of the learning rate tend to give more accurate results but lead to slow convergence. Excessively large values may lead to inaccurate results or even divergence.

In order to improve the training, the full training data set can be used many times. A single pass through the entire data set is called an *epoch*. Each single image is processed by the CNN a number of times equal to the number of epochs during the training, as part of different mini-batches. The optimal number of epochs has to be sufficiently large to extract all the information from the training set, but not too large to slow down the training process or to lead to overfitting (i.e. the CNN starts 'learning' even from the noise).

A successful Deep Learning network design results from an appropriate combination of the various layers. COSMODEEP implements the CNN model shown in Fig. 1, consisting of five hidden layers, two convolutional layers with 32 and 64 features maps, respectively, two pooling layers adopting a max pool algorithm and a fully connected 1024 neurons layer. This rather simple model, accounting for about 700 000 parameters (weights plus biases, their number being

independent of the size of the input images), is effective for our purpose. The software has been developed using the TensorFlow toolkit (Abadi et al. 2015) (version currently used: 1.2.1), providing the basic CNN building blocks. TensorFlow deploys a PYTHON API, which has been used for fast and effective prototyping, while the library functions are developed using the C++ programming language for performance purposes. The library efficiently exploits GPUs and provides a distributed interface supporting multi-CPU architectures.

3 THE IMAGE SET

Data represent the 'fuel' of any Deep Learning engine. The availability of a sufficiently *large, labelled* training data set is one of the most critical aspects in the adoption of a Deep Learning based approach. In the case of data coming from radio observation, sufficiently big data sets are not available, hence we need to generate training data from scratch exploiting the results of numerical simulations (usually training requires thousands or tens of thousands of images). These results are processed in order to calculate emission at the wavelengths of interest. They are then projected in order to get two-dimensional sky views and further combined with noise and artefacts to mimic actual observations. Finally, the resulting images are automatically labelled. The full procedure is described in the following sections.

3.1 Image generation

The images created for training need to have size and complexity similar to those expected from real radio observations. As a test case we considered here the case of a survey made with the Australian telescope ASKAP, the pathfinder of the Square Kilometer Array.¹ ASKAP consists of 36 antennas, each 12 m in diameter, with a typical observing frequency of 1.4 GHz, wide field of view, large spectral bandwidth, extremely fast survey speed, and excellent $u-v$ coverage (Johnston et al. 2008). First scientific results obtained with the 'BETA' ASKAP configuration based on six antennas have already been presented (Serra et al. 2015; Heywood et al. 2016).

We used as a reference a suite of large cosmological simulations of extragalactic magnetic fields, obtained using the cosmological

¹<https://www.atnf.csiro.au/projects/askap/index.html>

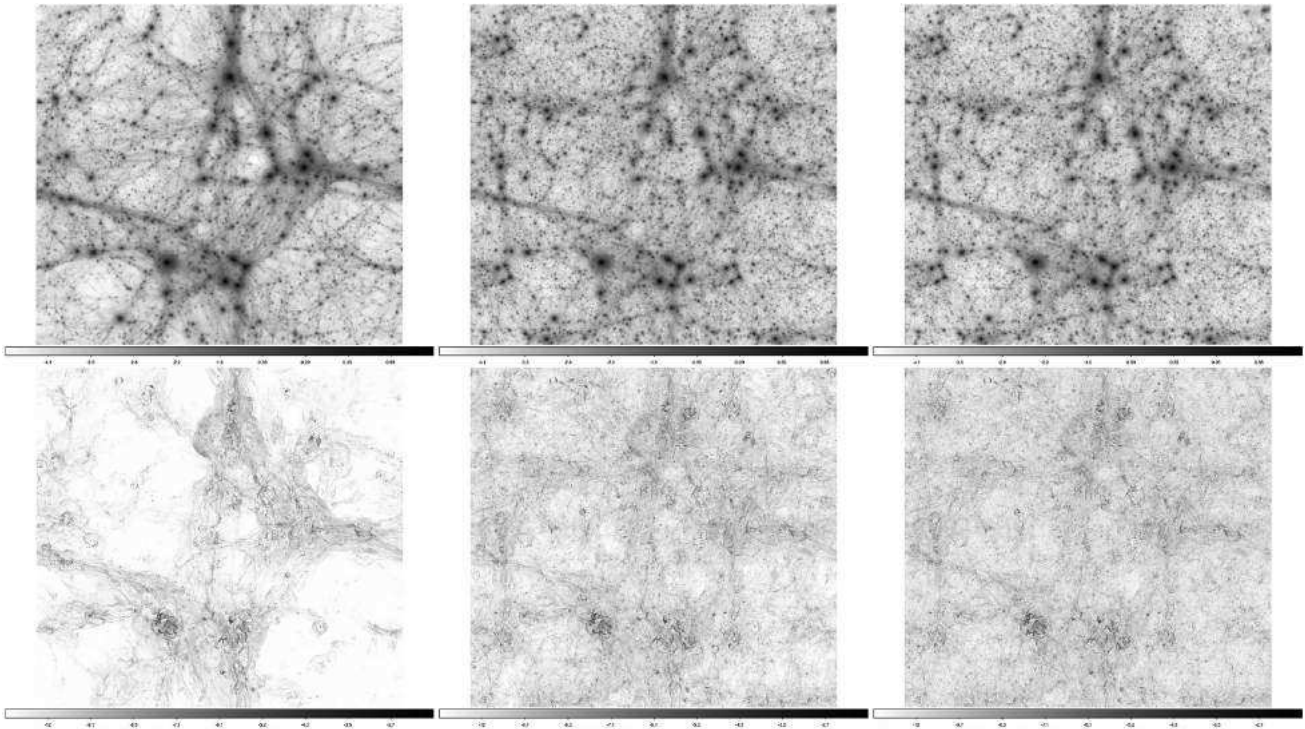

Figure 2. Progression of our sky model for a $16 \times 16 \text{ deg}^2$ area, as a function of the maximum redshift of integration: $z = 0.04$ (first panel), $z = 0.2$ (second) and $z = 0.5$ (third). The top row shows the projected gas density while the second row shows the total radio emission, at the frequency of ASKAP.

code *Enzo* (Bryan et al. 2014) as in Vazza et al. (2014, 2017) and Gheller et al. (2016). Our simulations evolved a uniform primordial seed field of $B_0 = 1 \text{ nG}$ (comoving) from high redshift ($z_{\text{in}} \geq 40$, the specific figure is dependent on the simulation) in different physical volumes of 200^3 , 100^3 and 50^3 Mpc^3 , in each case with a total number of cells and dark matter particles of 2400^3 . This model of extragalactic magnetic fields is on the optimistic side, as the assumed initial seed field is at the level of existing upper limits of primordial fields derived from the analysis of the Cosmic Microwave Background (Planck Collaboration et al. 2016), and based on our previous studies on the subject it yields a non-negligible chance of detecting the tip of the iceberg of the magnetic cosmic web (Vazza et al. 2015, 2017).

To compute the level of radio emission from cosmic shocks at each redshift, we assume that shocks can accelerate relativistic particles producing continuum and polarized radio emission (e.g. Brown 2011). We rely on the synchrotron emission model by Hoeft & Brügger (2007), which requires the jump condition of each cell undergoing shocks (computed from the simulation), the local value of the magnetic field and the electron acceleration efficiency as a function of Mach number (which is calibrated on shocks internal to galaxy clusters, as in Vazza et al. 2015).

The cosmological model adopted in our simulations has the following parameters: $\Omega_\Lambda = 0.692$, $\Omega_M = 0.308$, $\Omega_b = 0.0478$, $H = 67.8 \text{ km s}^{-1}$ and $\sigma_8 = 0.815$. The volumes are resolved with different cell sizes (83.3, 41.65 and 20.82 kpc, respectively), which is motivated by the fact that our final mock observation is obtained by stacking together the different volumes along the line of sight (with the larger volumes/lower resolution runs being placed at larger distance), which approximately yields a constant angular resolution for all simulations at the corresponding redshifts ($\sim 25\text{--}35 \text{ arcsec}$). While this is the intrinsic angular resolution of our simulation (given the starting redshift of the cone integration), we further resampled

our images down to an $\approx 10 \text{ arcsec}$ angular resolution for the full ASKAP array configuration.

A detailed description of the procedure adopted to generate mock radio lightcones is given in Vazza et al. (2015). To briefly summarize, we create long rectangular volumes covering $16^\circ \times 16^\circ$ in the sky, i.e. of the order of 9 independent ASKAP fields of view. Based on Vazza et al. (2015), we do not expect to detect a significant amount of radio emission from the cosmic web beyond $z \geq 0.5$, hence we limit our analysis to the cosmic volume in the range $0.04 \leq z \leq 0.5^2$ (corresponding to a comoving radial distance of $\approx 1.892 \text{ Gpc}$). This volume is assembled by stacking many simulated boxes along the line of sight, starting with a few replicas of our most resolved $(50 \text{ Mpc})^3$ box, and then adding several replicas of the $(100 \text{ Mpc})^3$ and of the $(200 \text{ Mpc})^3$ volumes. We first compute the radio emission in the comoving reference frame of each box, and then apply redshift corrections (e.g. cosmological dimming as a function of redshift), assuming the redshift corresponding to the box centre for each box. Building the redshift cone, the projected pixel size is adjusted with a cubic interpolation, while the presence of artefacts due to the periodicity of structures along the line of sight is minimized by applying random

²We notice that our lower limit on the integration redshift 0.04 is motivated because even if there surely are cosmic structures between us $z = 0.04$, at the frequency of ASKAP this part of the diffuse emission from the shocked cosmic web gets mostly filtered because of the missing baselines. Due to the vastly larger data set we need to analyse here, in this work we do not explicitly perform the removal of missing baselines from our mock observations, unlike in previous work (Vazza et al. 2015). Therefore, we limit by construction our analysis to structures that are located at a large enough redshift to be properly sampled by ASKAP. For simplicity, we also do not consider the radio artefacts that typically arise as a result of the ‘cleaning’ procedure of real images (e.g. Grobler et al. 2014).

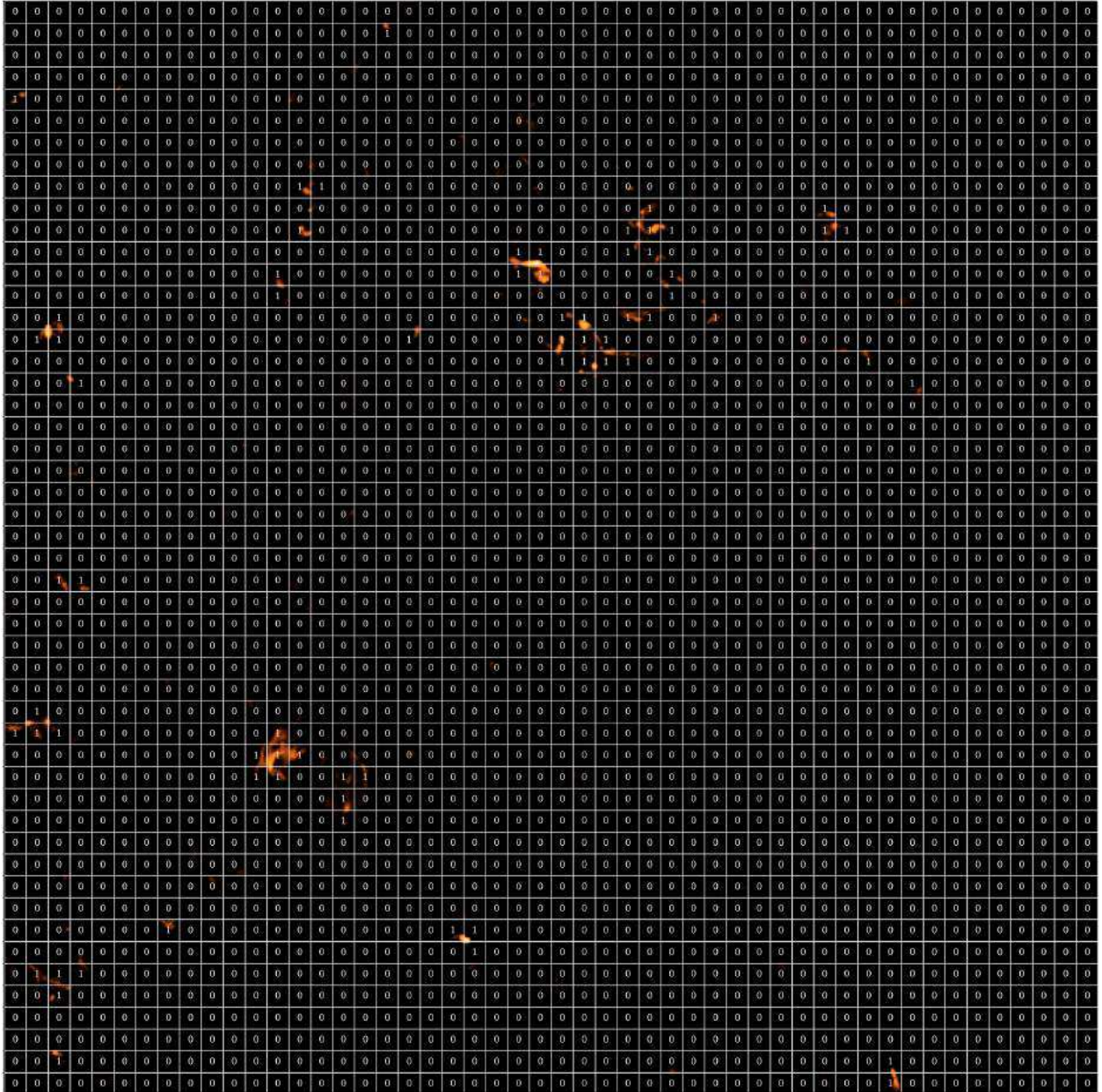

Figure 3. A full 2000x2000 pixel Sky image tiled and labelled: label 0 corresponds to a tile without signal (according to our criteria), while label 1 corresponds to a tile with some signal.

rotations to each box. An example of our final result is shown in Fig. 2.

Massive haloes ($\geq 10^{12} M_{\odot}$) can be identified by running a spherical-overdensity-based halo finder at each different redshift, allowing to disentangle the fraction of the radio emission coming from the cosmic web from that coming from galaxy clusters. More details on the procedure to create the mock images can be found in Vazza et al. (2015).

We generated a final set of 1000 independent sky model images by applying random rotations to each of the different redshift slices used to produce our lightcones. The maximum spatial resolution achieved in our most resolved box (≈ 20 kpc) corresponds to an angular resolution of ≈ 0.8 kpc at $z = 0.04$, i.e. 25 arcsec per pixel. In order to match the ASKAP angular resolution (10 arcsec), sky

models have been re-sampled to a 2.5 higher resolution. Furthermore, realistic noise has been added at the scale of ~ 3 arcsec, in order to adequately sample the FWHM of the restoring beam, further re-sampling the sky model at ~ 8.3 times higher resolution and then convolving it with a Gaussian profile with a FWHM of 10 arcsec to emulate a *cleaned* ASKAP observation. The assumed noise level is chosen so that $\sigma_{\text{rms}} = \sigma_{\text{ASKAP}} \approx 10 \mu\text{Jy beam}^{-1} = 0.88 \times 10^{-7} \text{ Jy arcsec}^{-2}$.

In summary, the described procedure was used to generate 6000×6000 pixel images, from which smaller 2000×2000 pixel subsets (corresponding to an ASKAP field of view) have been extracted. These images are indicated as *Sky images* and represent the data set used for the labelling procedure described in Section 3.3. Adding the noise to the Sky images, the cleaned im-

ages are obtained. This data are indicated as *Noise images*. The Noise data set is used for the training of the CNN and to test its performance.

3.2 Tiling

The 2000×2000 pixel images comprise a wide field of view, with tens or even hundreds of potentially interesting objects to detect. In order to identify each single object and its position in the image we have implemented a tiling-based procedure that divides each image in small square tiles. The tiles become the actual training data set of the CNN and each single tile is classified as containing some signal or not. The mosaic of the tiles with signal defines the positions in the sky to observe for radio emitting objects. In order to have a precise localization of the objects, the tile size has to be the smallest possible. However, tiles cannot be so small that objects cannot be identified along with their shape and geometric information (i.e. objects should not fill the entire tile). After some experimentation, effective linear tile sizes resulted to be between 40 and 80 pixels. The smallest size, 40 pixels, has been adopted in order to get the highest spatial precision. The result of the tiling procedure is shown in Fig. 3, where the mesh composed by the tiles is overlaid on one of the Sky images.

3.3 Labelling

Labelling is the process of classifying the content of an image so that it can be used to train the Deep Learning model. The labels are assumed to provide the correct values and are used to validate results of the CNN analysis. In our case, images are divided into tiles and each tile has to be defined as containing some radio signal or not. Labelling has, of course, to be performed independently from the Deep Learning network we are training. It is common practice to perform labelling by means of human classification, or using so-called 'bootstrap' procedures which are semi-automated and still require human supervision. This can be an overwhelming task (especially when hundreds of thousands of images have to be classified), prone to errors and subjectivity, in particular when the target is not a well-defined object and noise can blur the content of the image.

In order to properly label our radio catalogue we exploited the Sky images, which are free from noise contamination. A tile containing meaningful signals is positively labelled if the number of pixels emitting above a given flux threshold, F_{th} , is larger than N_{pix} . We set $F_{\text{th}} = \alpha 10^{-7} \text{ Jy arcsec}^{-2}$. For $\alpha = 1$, F_{th} is of the order of the typical signal-to-noise ratio (SN) considering the (conservative) expected thermal noise level of continuum ASKAP observations for a 10 arcsec beam (see Section 3.1). Reducing the value of α below 1, we include increasingly fainter sources in the analysis. The parameter N_{pix} sets the minimum size of an object to be labelled as a source; this allows tuning the training of the CNN to identify signals of that size or bigger and excluding point-like sources or objects too small to have meaningful geometric information for the CNN to work with.

The result of the labelling procedure with $\alpha = 1$ and $N_{\text{pix}} = 40$ is presented in Fig. 4, where we show a zoom into one of the 2000×2000 Sky images. Tiles labelled as '0' have no signal, while those labelled as '1' contain radio sources.

Once the parameters F_{th} and N_{pix} are set, the labelling process is completely automated. The labels are then used in the training and testing phases where tiles are extracted from the Noise data set, clas-

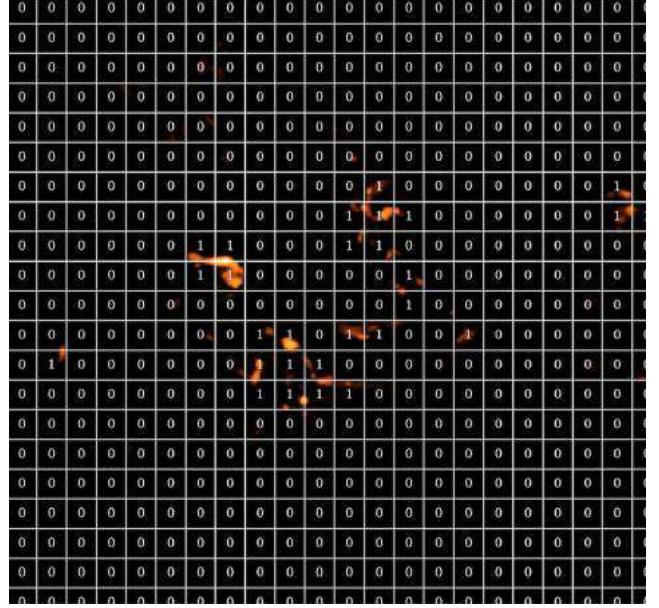

Figure 4. A zoom into a 2000×2000 tiled and labelled Sky image. Label 0 corresponds to a tile without signal, while label 1 corresponds to a tile with some signal.

sified by the CNN, and the results compared to the corresponding labels.

4 PARAMETERS TUNING AND PERFORMANCE

The accuracy of our CNN model has to be properly estimated in order to avoid misinterpretation of the results and incorrect conclusions. Accuracy, in the simplest case, can be defined as the ratio between the number of images correctly classified and the total number of images used in the test. In our case, such estimate is misleading since the number of tiles with no signal can be one or even two orders of magnitude bigger than that of tiles with signal (see Figs 3 or 4). This definition of accuracy means that simply classifying tiles with no signal would give a very high accuracy regardless of how the tiles with signal are classified. Therefore, we have defined the following accuracy metrics:

$$A_s = N_{\text{sc}} / (N_s + N_{\text{vw}}), \quad W_v = N_{\text{vc}} / N_v, \quad W_s = N_{\text{sc}} / N_s, \quad (2)$$

where A_s gives the fraction of correctly classified signals (N_{sc}) over the sum of the total number of tiles that have signal (N_s) plus the number of tiles classified as signal but actually are noise (N_{vw}). This gives the probability that a tile classified as signal is an actual signal. In other words, it gives the probability that a real signal will be detected by pointing the radio telescope to the region of sky contained by a tile classified as signal. The parameters W_v and W_s measure the relative accuracy for each of the two classes, i.e. the ratio between the number of correctly classified tiles in a class and the total number of tiles belonging to that class. The parameter N_{vc} is the number of tiles with no signal that are correctly classified. Overall, the three parameters describe the accuracy of the CNN, and ideally $A_s = 1$, $W_v = 1$, $W_s = 1$.

We have run a number of tests investigating the influence of several parameters on the training of the model, namely the learning rate (η), the batch size (N_b) and the number epochs (N_e), all defined in Section 2. For the labelling we have set the parameter α ,

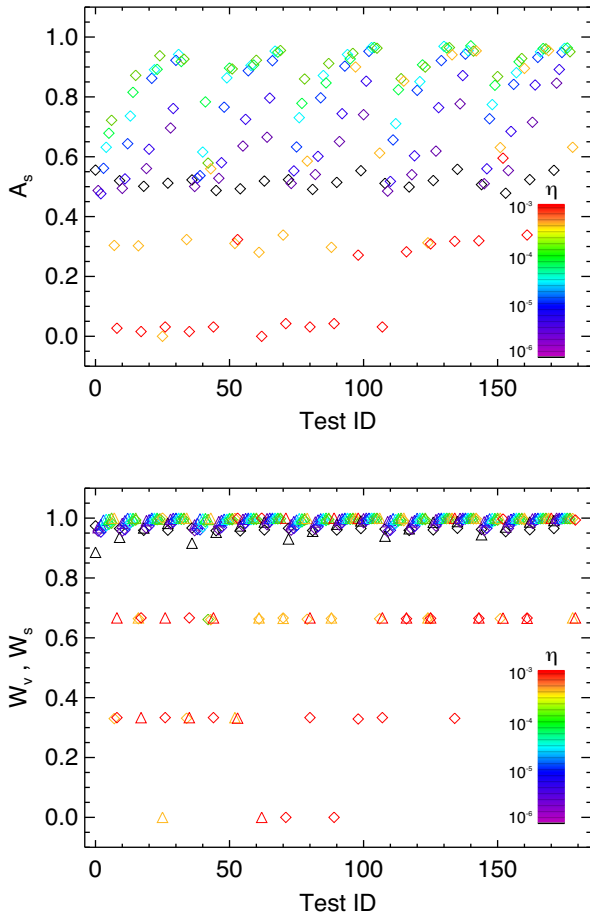

Figure 5. Accuracy parameters A_s (top panel), W_v and W_s (diamonds and triangles, respectively, bottom panel) in tests with different combinations of learning rate, batch size and number of epochs (η , N_b , N_e). The three parameters can take the following values: $\eta = [10^{-6}, 5 \times 10^{-6}, 10^{-5}, 3 \times 10^{-5}, 5 \times 10^{-5}, 7 \times 10^{-5}, 10^{-4}, 5 \times 10^{-4}, 10^{-3}]$, $N_b = [15, 30, 50, 64, 100]$, $N_e = [10, 20, 50, 100]$. Each combination (η , N_b , N_e) is characterized by a different TestID (an integer number between 1 and 180). Colours (in logarithmic scale) represent the parameter η .

introduced in Section 3.3, equal to 1. This means that the minimum signal we consider is at the same level of the noise. Furthermore, two different values for N_{pix} have been tested: $N_{\text{pix}1} = 40$, which focuses on extended sources, and $N_{\text{pix}2} = 9$, which corresponds to the size of the local receptive field of the CNN, setting the resolution of the method.

All the tests have been performed on an Intel Xeon E5-2690 ‘Haswell’ CPU running at 2.60GHz (12 cores, 64GB RAM) equipped with NVIDIA Tesla P100 with 16GB HBM2 memory, which is effectively exploited by COSMODEEP through TensorFlow. The computing environment is part of the Piz Daint supercomputer, available at the Swiss National Supercomputing Center in Lugano (operated by ETH Zurich). The size of the input data set is about 6.5 GB, mostly used as training set and a small fraction dedicated to testing and validation.

The following workflow is implemented for the training and testing of the CNN:

- (i) Sky and Noise images are read from files stored on disc;
- (ii) negative pixels are set to a small floor value (typically 10^{-11} Jy arcsec $^{-2}$), and the logarithm of each pixel is calculated in order

to reduce the dynamical range of the emissivity, which typically spans 10 orders of magnitude (10^{-11} to 10^{-2} Jy arcsec $^{-2}$), avoiding issues related to floating point precision;

- (iii) the results are normalized so that each image has values between 0 and 1;
- (iv) images are divided into tiles;
- (v) using the Sky tiles, each tile is labelled according to the procedure described in Section 3.3;
- (vi) tiles are serialized to feed the CNN;
- (vii) tiles are offloaded to the GPU (in chunks, in order to avoid GPU memory overflows) and there processed by the CNN for the training;
- (viii) the trained network is finally tested and its accuracy calculated.

The resulting accuracy for the case $N_{\text{pix}1}$ is presented in Fig. 5. The top panel shows A_s as obtained for the different combinations of η , N_b and N_e . Colours highlight the dependence on the learning rate. In a number of cases, the accuracy is above 0.9. The highest values for A_s are obtained by setting the learning rate bigger than 10^{-5} . However, for $\eta > 5 \times 10^{-4}$ accuracy drops and convergence is not reached. For $\eta < 10^{-6}$ the convergence is slow. The mini-batch size progressively grows with the TestID, starting from $N_b = 15$ for TestID < 20 , up to $N_b = 100$ for $160 \leq \text{TestID} < 180$, stepping up every 20 TestIDs. Its influence can be seen in the overall trend of the accuracy to slightly increase when shifting towards higher TestIDs, from left to right (to higher mini-batch sizes). Accuracy is also improved by increasing the number of epochs. We have performed tests using four different numbers of epochs ($N_e = 15, 20, 50, 100$). The accuracy of the method grows at larger N_e , as can be seen from the tendency of the accuracy of matching coloured (i.e. η) point data to have higher A_s moving toward larger values of TestID. This continues until the mini-batch size is updated to a new value, when A_s drops. The same behaviour is shown in the bottom panel of the figure for the parameters W_s and W_v , although most of data points are close to unity and the trend is less recognizable. Tests with the highest values of η (yellow and red points) have low accuracy and do not present any trend varying both the number of epochs and the mini-batch size, showing that their accuracy cannot be improved by tuning the two parameters.

The bottom panel of Fig. 5, which shows the relative accuracy parameters W_s and W_v , confirms the results discussed above. In most cases COSMODEEP is capable of successfully classifying more than 99 per cent of both regions with signals and empty regions.

When decreasing the pixel threshold to $N_{\text{pix}2}$ pixels (not shown), objects at the limit of the resolution of the method are included, leading to a slightly lower accuracy. The overall trends, however, are the same as in the $N_{\text{pix}1}$ case.

Fig. 6 shows the convergence of the training process as a function of the epoch, for the case $N_{\text{pix}1}$, with different settings of η and N_b . The set-ups with $5 \times 10^{-5} \leq \eta \leq 10^{-4}$ and $N_b \geq 30$ (green and blue curves in the figure) have the fastest convergence towards an accuracy close to 1. For this specific test the accuracy is calculated as the ratio between the number of tiles correctly classified and the total number of tiles used for the test. For $\eta < 5 \times 10^{-5}$ the algorithm converges but very slowly, while for $\eta > 10^{-4}$ most of the tests do not converge, the accuracy fluctuates around 0.5 which corresponds to random classification. Few cases with $\eta \geq 5 \times 10^{-4}$ and $N_b > 50$ converge faster than in all the other cases. However, their A_s , W_s and W_v are low, proving that the training is not actually effective, only tiles without signal being correctly classified. Similar results are obtained for $N_{\text{pix}2}$.

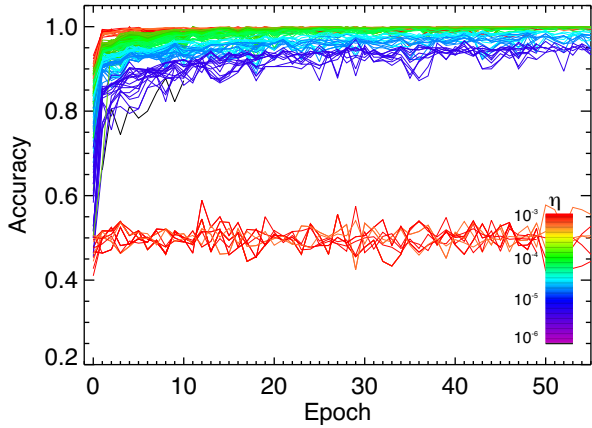

Figure 6. Convergence of the training process as a function of the number of epochs, measured by an accuracy parameter defined as the fractional difference between the tiles correctly classified and the total number of tiles used for measure. A constant value of the accuracy indicates that the training cannot improve more. The optimal value for the accuracy is 1, which indicates that all the images are correctly classified. Colours (in logarithmic scale) show the dependency from the learning rate η .

In terms of computational requirements, the training takes around 1800–2500 s to complete, the time depending essentially from the number of epochs. The trained network can be stored in files and reloaded for later usage for image classification. The CNN network load and setup time is independent of the number of images to classify, depending only on the size of the network, while the classification stage scales linearly with the image size. For our 2000×2000 pixel images, the estimated classification performance is 10.4 ± 0.2 images s^{-1} .

5 RESULTS

The effectiveness of COSMODEEP in detecting faint, diffused radio sources in noisy images has been analysed on a subset of images, the test data set, never used for the training. The CNN has been trained for the two different choices of N_{pix} , indicated as $N_{\text{pix}1}$ (40 pixels) and $N_{\text{pix}2}$ (nine pixels). The parameters listed in Table 1 have been set in order to optimize the performance of the CNN according to the analysis performed in Section 4. Fig. 7 shows one of the test images, with tiles labelled as follows: tiles classified as '1C' are signals correctly detected by the CNN, '1F' indicates tiles with signal but classified as pure noise (false negatives), tiles with '0F' are pure noise tiles classified as signal (false positives). The remaining tiles, labelled as '0C', are correctly classified as pure noise and for clarity their label is not displayed in the image.

In the case $N_{\text{pix}1}$, we get the following accuracy estimates: $A_s = 0.9088 \pm 0.0090$, $W_s = 0.9827 \pm 0.0003$, $W_v = 0.9974 \pm 0.0003$. On average our classifier misses around one to two tiles with signal (40×40 pixels) per 2000×2000 pixel image (out of a total number of 2500 tiles), and it misclassifies around six pure noise tiles per image. The CNN proves to be effective in detecting extended objects (at least bigger than 40 pixels) missing less than 2 per cent of them. The accuracy improves for regions without emission, even if the absolute number of false positives is larger than that of false negatives. The case $N_{\text{pix}2}$ returns $A_s = 0.8800 \pm 0.0062$, $W_s = 0.9710 \pm 0.0062$, $W_v = 0.9957 \pm 0.0003$, with, on average, around two to three tiles misclassified as 1F and around 10 as 0F per image. The total number of tiles with signal increases from around 600 in

the $N_{\text{pix}1}$ case to around 800 in the $N_{\text{pix}2}$, since smaller objects are classified as sources by the labelling procedure. Such smaller objects are also more challenging to recognize, being at the limit of the resolution of the CNN. This explains the slight decrease of accuracy in the $N_{\text{pix}2}$ case.

Fig. 8 zooms into three regions extracted from one test image, in the $N_{\text{pix}1}$ (upper row) and in the $N_{\text{pix}2}$ (lower row) cases. In the top-left panel, we see a region with a prominent cluster of galaxies with a clear pattern of shock waves moving outwards from the cluster centre. In the $N_{\text{pix}1}$ case most of the tiles with signal are correctly classified (1C) and one false positive is present. The false positive (tile labelled as 0F) identifies a tile that is actually part of the cluster, but the number of pixels above F_{th} is less than $N_{\text{pix}1}$. Lowering the pixel threshold to $N_{\text{pix}2}$, the same tile results to be classified as 1C. Therefore, the false positive in the $N_{\text{pix}1}$ case follows from the labelling procedure, and not from the CNN. In the top-central panel, a small object is detected, split into three tiles. In the $N_{\text{pix}1}$ case one of the tiles is again misclassified due to the labelling method, showing that the CNN can indeed correctly detect and classify sources below the pixel threshold it has been trained for. The right panels show the example of a filament connected to a galaxy cluster, which appears in the bottom-left corner of the image. The structure, albeit elongated and discontinuous, can be properly identified by the CNN. A false positive is present in the $N_{\text{pix}2}$ case and is again a shortcoming of the labelling procedure (i.e. there are not enough pixels above the flux threshold in the tile), and not an error of the CNN.

In the top-left panel we can also see how in the $N_{\text{pix}1}$ case, several tiles contain sources which get labelled as noise, and are not detected by the CNN. A couple of these tiles are classified as false negative in the $N_{\text{pix}2}$ case (bottom-left panel). The sources contained in these tiles are larger than $N_{\text{pix}1}$ pixels but too faint, hence they are labelled as noise. Accordingly, the CNN is trained to classify those kind of objects as noise. Reducing the pixel threshold to $N_{\text{pix}2}$, a sufficiently large number of pixels in both tiles are brighter than F_{th} , hence they are labelled as sources. However, the CNN is not able to detect them as most of the source still emitting below the flux threshold the CNN has been trained for.

In order to investigate the influence of F_{th} in detail, we have repeated the whole training and testing procedure reducing the value of the flux threshold progressively to 0.75, 0.5 and 0.1×10^{-7} (Jy arcsec $^{-2}$), trying to detect signals with smaller and smaller SN. All the other parameters of the CNN are unchanged (see Table 1)

The results, presented in Table 2, show that for the $N_{\text{pix}1}$ model, down to $F_{\text{th}} = 0.5 \times 10^{-7}$ (Jy arcsec $^{-2}$), A_s is bigger than 0.9 and both the parameters W_v and W_s are close to 1. For $N_{\text{pix}2}$, the accuracy parameter A_s is slightly lower, due to the presence of smaller objects to be detected, but still of the order of 0.9. The W_v parameter is very close to unity, while W_s is around 0.97. In both cases the best accuracy is achieved for $F_{\text{th, opt}} = 0.75 \times 10^{-7}$ (Jy arcsec $^{-2}$), so below the rms noise, with on average around 0.5 and 3 false negatives and 6 and 7 false positives per image for the $N_{\text{pix}1}$ and $N_{\text{pix}2}$ cases, respectively. The higher accuracy reached at $F_{\text{th, opt}}$ is due to the inclusion in the training set of faint sources that at higher flux thresholds are labelled as noise but that are detectable by the CNN. The mismatch between labelling and classification leads to a slightly less efficient training with some loss of accuracy at $F_{\text{th}} = 10^{-7}$ (Jy arcsec $^{-2}$). Below $F_{\text{th, opt}}$ the accuracy decreases due to the presence of smaller and fainter sources, blurred by the noise. At $F_{\text{th}} = 0.1 \times 10^{-7}$ (Jy arcsec $^{-2}$) accuracy drops, in particular for

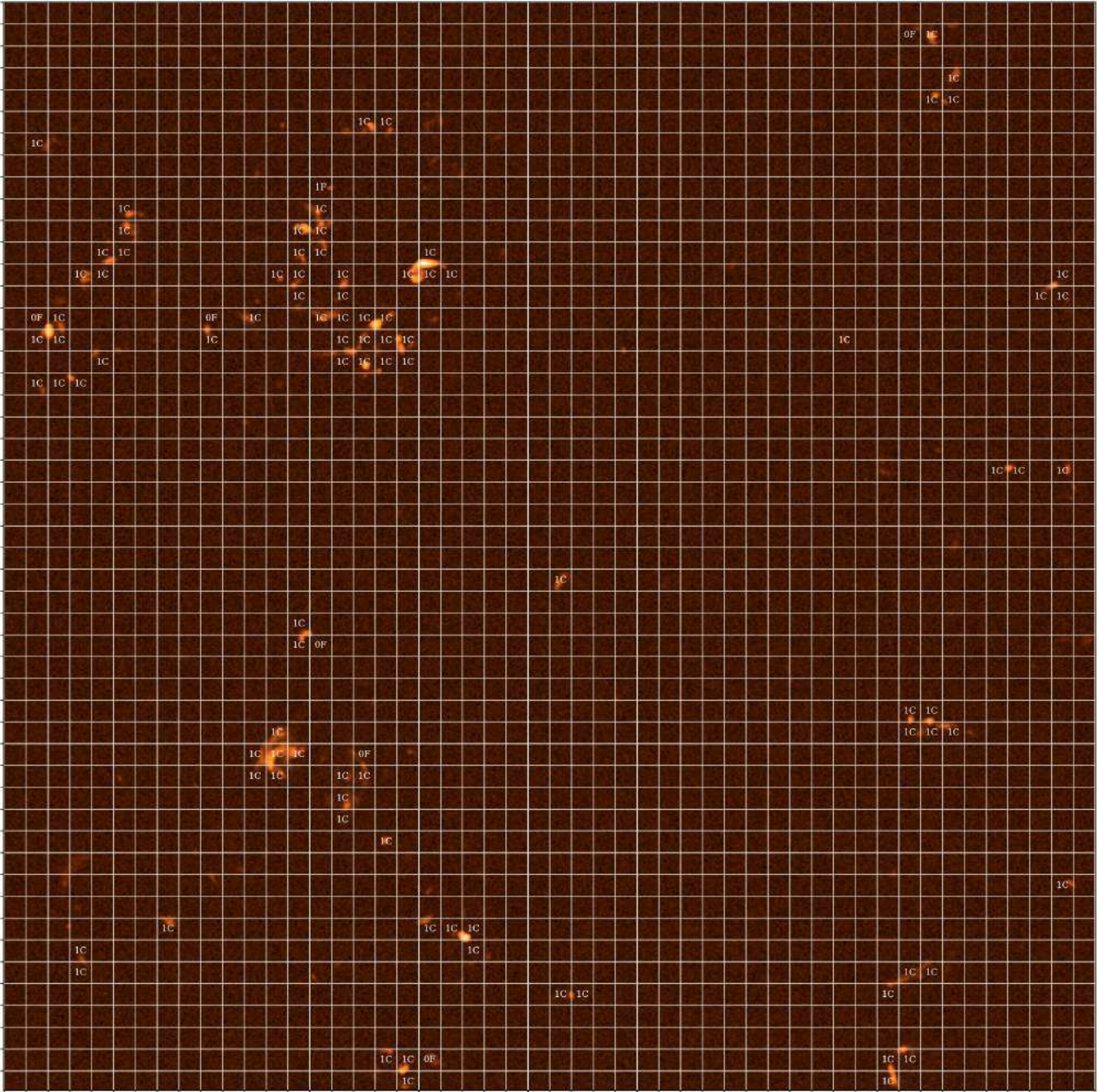

Figure 7. A full 2000×2000 pixel image classified by COSMODEEP. Label 1C refers to correctly classified signals, 1F indicates tiles with signal incorrectly classified as noise (false negatives), 0F indicates tiles with no signal and wrongly classified (false positives). Unlabelled tiles indicate pure noise tiles correctly classified.

$N_{\text{pix}2}$, with A_s slightly bigger than 0.8, and, on average, around 60 misclassified tiles per image.

Fig. 9 shows the same regions of Fig. 8 for the case $N_{\text{pix}2}$, but at $F_{\text{th, opt}}$ (top row) and $F_{\text{th}} = 0.1 \times 10^{-7} (\text{Jy arcsec}^{-2})$. At $F_{\text{th, opt}}$ all the tiles are correctly classified. The false negatives on the bottom-left panel of Fig. 8 are now correctly classified, since the CNN is trained to recognize those faint sources. At $F_{\text{th}} = 0.1 \times 10^{-7} (\text{Jy arcsec}^{-2})$, more tiles are labelled as containing signal and classified as 1C. As expected, a few incorrect classifications appear due to the presence of extremely faint and small objects the CNN is not able to detect or the labelling schema neglects.

We compared the results of COSMODEEP with those obtained using PYBDSF (the PYTHON Blob Detector and Source Finder; see <http://www.astron.nl/citt/pybdsf>), which is a PYTHON-based tool to decompose radio interferometric images into sources. Since PYBDSF is designed to work on real images, several parameters can be set by the users to distinguish e.g. regions in the image with different noise properties (e.g. different noise due to imaging artefacts around strong sources). For our purposes, we have run the tool adopting standard input parameters, setting the noise level to a constant value of $\sigma_{\text{rms}} = 10 \mu\text{Jy beam}^{-1}$. We considered as islands of signal regions in the image that show at least nine contiguous

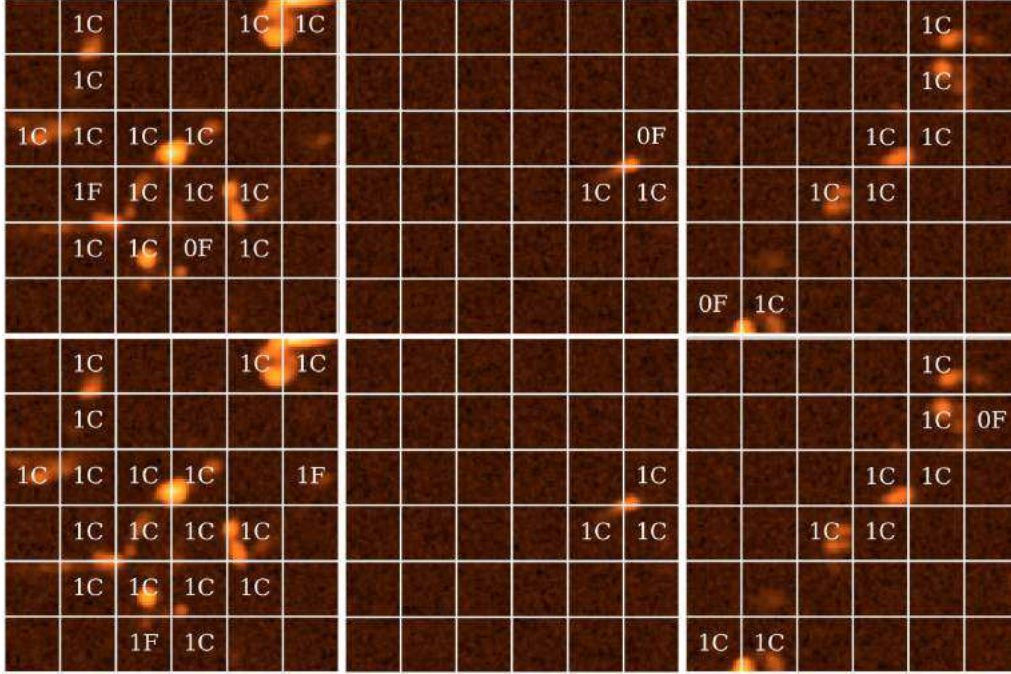

Figure 8. Mosaics of tiles extracted from the full images for $F_{\text{th}} = 10^{-7}$ (Jy arcsec^{-2}), with different kind of classification. Label 1C refers to correctly classified signals, 1F indicates false negatives, 0F false positives. Unlabelled tiles indicate pure noise tiles correctly classified. Upper row refers to $N_{\text{pix}1}$, bottom row to $N_{\text{pix}2}$.

pixels above the assumed flux threshold (to allow a close comparison with COSMODEEP), and tested variations in rms noise level from 0.75 to 3.0. Using the above parameters, we identified islands with signals of contiguous emission as shown by the green contours in Fig. 10. In a second step, the algorithm fits a Gaussian profile to each island, in order to further decompose them into shapelets. The final result is a catalogue of sources with positions, sizes, and flux densities of each source. However, this second step is not required for our purposes, as the islands already identify the regions in the image where emission above threshold is detected by the algorithm.

We compare in Fig. 10 the results of COSMODEEP to those of PYPDSF at different values of F_{th} , for two $\sim 2^\circ \times 1:5$ fields, featuring several diffuse emission patches. Sources identified by PYBDSF for different choices of F_{th} are given in green contours, while the rectangular tiles identified by COSMODEEP are marked by the white contours. We find a tight correspondence between the islands of signal identified by PyBDSF imposing a threshold of $\text{SN} \geq 3.0$ and the results of COSMODEEP for $F_{\text{th}} \geq 0.5 \times 10^{-7} \text{Jy arcsec}^{-2}$ with a lower bound of nine pixels for the size of structures. Interestingly, lowering the threshold to $F_{\text{th}} \geq 0.1 \times 10^{-7} \text{Jy arcsec}^{-2}$ and using 40 pixels for the

size of structures allows COSMODEEP to correctly identify a few more fainter low-surface brightness structures in the sky model, while lowering the threshold in PyBDSF to $\text{SN} \geq 1.5$ causes the software to detect a large number of spurious noise fluctuations, randomly spread across the field (see right panels in Fig. 10).

While further ad hoc improvement in PyBDSF is surely possible, this test shows that the two algorithms can give consistent results on the high SN end of the distribution of sources, while with very little tuning COSMODEEP can go significantly below the 'standard' $2-3 \sigma_{\text{rms}}$ level for the detection of *real* diffuse emission from the cosmic web. On the other hand, the spatial resolution of COSMODEEP is limited to the tile size, which prevents us from exactly describing the shape of these emission regions. Based on the above results, it seems possible to design a combined approach in future work, where COSMODEEP and PyBDSF may be applied to large data sets in two different steps, to better trace the location of diffuse emission structures at a scale comparable to the restoring beam of observations.

Finally, we present in Fig. 11 the statistical analysis of the distribution of tiles identified by COSMODEEP, in relation to their projected distance to galaxy clusters in the field, which we identify in a sep-

Table 2. Accuracy parameters of COSMODEEP for different values F_{th} , corresponding to models $N_{\text{pix}1}$ and $N_{\text{pix}2}$.

Model	F_{th} (Jy arcsec^{-2})	A_s	W_s	W_v
$N_{\text{pix}1}$	10^{-7}	0.9088 ± 0.0090	0.9827 ± 0.0003	0.9974 ± 0.0003
	0.75×10^{-7}	0.9232 ± 0.0046	0.9947 ± 0.0002	0.9972 ± 0.0002
	0.5×10^{-7}	0.9159 ± 0.0070	0.9958 ± 0.0005	0.9960 ± 0.0004
	0.1×10^{-7}	0.8934 ± 0.0072	0.9521 ± 0.0005	0.9933 ± 0.0005
$N_{\text{pix}2}$	10^{-7}	0.8800 ± 0.0062	0.9710 ± 0.0062	0.9957 ± 0.0003
	0.75×10^{-7}	0.9175 ± 0.0051	0.9754 ± 0.0037	0.9969 ± 0.0001
	0.5×10^{-7}	0.9022 ± 0.0046	0.9797 ± 0.0044	0.9948 ± 0.0001
	0.1×10^{-7}	0.8181 ± 0.0035	0.8848 ± 0.0023	0.9890 ± 0.0011

Table 1. Set-up of the CNN models.

Parameter	Value
Image size (pixels)	2000×2000
Tile size (pixels)	40×40
$N_{\text{pix}1}$	40
$N_{\text{pix}2}$	9
F_{th} (Jy arcsec $^{-2}$)	10^{-7}
η	7×10^{-5}
N_b	100
N_c	50

arate step with a halo finder (working in three dimensions). We tentatively consider tiles falling within a $< R_{100}$ (i.e. the virial radius) from the centre of a nearby halo as ‘cluster emission patches’, and tiles at $\geq R_{100}$ distance as ‘cosmic web emission patches’. The tiles correctly classified by COSMODEEP as containing a structure have a distribution of pixel luminosities that peaks towards higher values. A very significant fraction of the structures correctly identified by COSMODEEP are related to shocked gas outside of the virial volume of clusters, which confirms that our technique is indeed capable of locating low surface brightness emission regions in the peripheral regions of galaxy clusters, which trace accretion shocks and shocks around filaments.

6 CONCLUSIONS

The work presented in this paper shows that a Deep Learning based methodology based on a CNN approach (COSMODEEP) offers an effective solution for the fully automated processing pipeline of big radio data sets, of the order of what is expected from next generations of surveys with radio telescopes (e.g. ASKAP, MEERKAT, MWA, LOFAR and the SKA). We explored the case study of ex-

tended cosmological radio sources (such as emission from shocked gas around galaxy clusters and filaments). COSMODEEP allows us to detect diffuse radio sources and to localize their position within large images thanks to a tiling-based procedure. The overall accuracy of the method is comparable to that of more standard tools used in radio astronomy, but it delivers better performance when applied to the detection of faint objects, with emissivity below the average rms noise of radio observations. The accuracy has been defined as the probability that a tile classified as signal contains an actual radio source. Depending on the specific set-up, accuracy is between 0.88 and 0.92, with only a few tiles misclassified per 2000×2000 pixel (2500 tiles) image. Such values have to be taken as a conservative lower bound, having proved that part of the observed inaccuracies are due to the tiling procedure and not to the CNN classifier itself.

The performance of COSMODEEP is not only promising in terms of accuracy and ability to identify faint diffuse objects, but its computational performance is also encouraging: 2000×2000 pixel images can be processed in less than 0.1 s on a state-of-the-art GPU, and their size does not represent an issue in terms of memory thanks to the effective implementation provided by the TensorFlow framework. The training can be easily managed on the computing nodes used for testing; the full training on $\sim 30\,000$ – $40\,000$ tiles requires less than one hour to be completed. Larger data sets, in terms of both image size and data volume, are potentially manageable as well, since TensorFlow supports distributed training on parallel high-performance computing architectures.

An important ‘by-product’ of our methodology is a set of mock radio images generated from cosmological numerical simulations. The image set is composed of *Sky* images used for automatic labelling, and *Noise* images derived from the *Sky* images by adding random noise in order to create realistic radio observations. The resulting data set is unique and it can be publicly accessed at <http://cosmosimfrazza.myfreesites.net/cosmodeep-training-datasets>.

In summary, this work led to the following achievements:

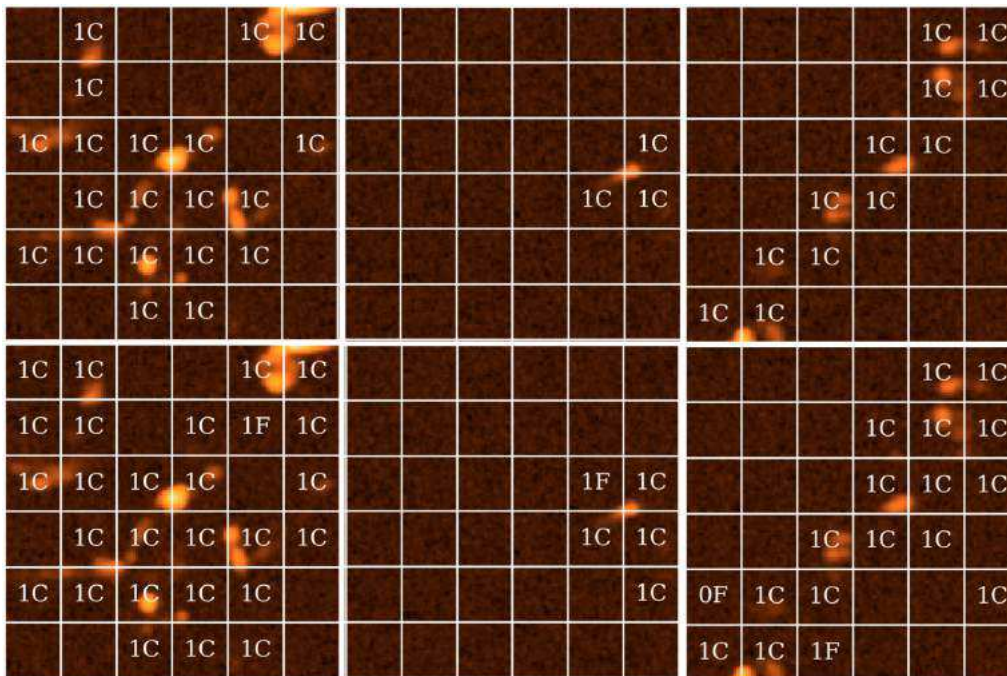

Figure 9. Mosaics of tiles extracted from the full images for the case $N_{\text{pix}2}$ at different values of F_{th} . For the top row $F_{\text{th}} = 0.75 \times 10^{-7}$ (Jy arcsec $^{-2}$), while for the bottom row $F_{\text{th}} = 10^{-8}$ (Jy arcsec $^{-2}$).

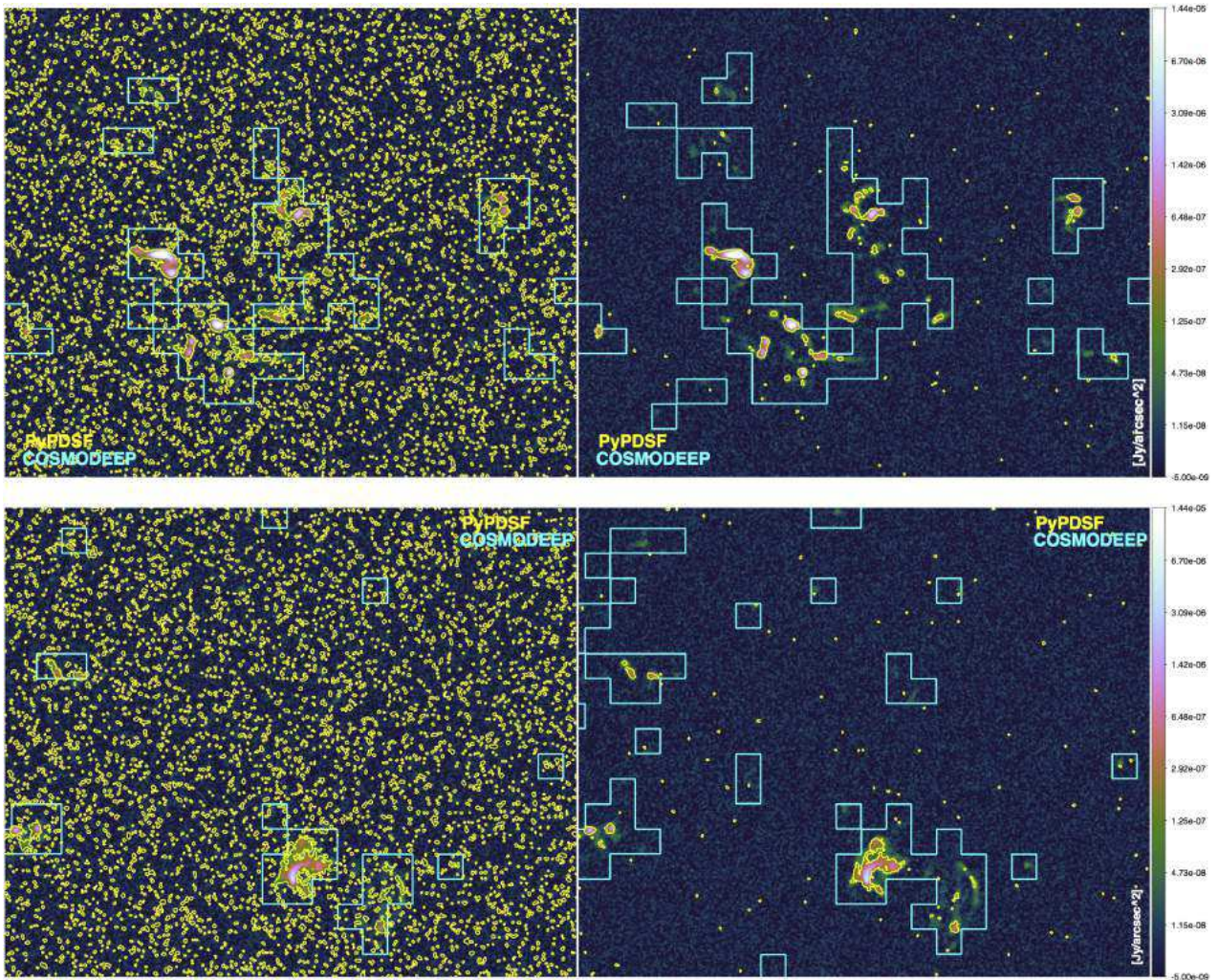

Figure 10. Close up view of two sample $\sim 2^\circ \times 1:5$ simulated maps, showing our noise-added mock sky model (colours, in units of Jy arcsec^{-2}). For the same sky model, we show with cyan contours all tiles correctly identified by COSMODOEEP using either $N_{\text{pix}} = 40$ and $F_{\text{th}} = 0.1 \times 10^{-7} \text{ Jy arcsec}^{-2}$ (left) or $N_{\text{pix}} = 9$ and $F_{\text{th}} = 0.5 \times 10^{-7} \text{ Jy arcsec}^{-2}$ (right). In the same panels, we also show with yellow contours the ‘islands of signal’ identified by PyBDSF assuming either threshold of 1.5 SN or 3.0 SN.

(i) availability of a novel methodology, based on a Deep Learning CNN approach, to detect diffuse and faint sources in radio observations, irrespective of their specific size or shape;

(ii) the methodology is competitive in terms of accuracy with state-of-the-art software adopting more standard approaches;

(iii) the methodology is flexible and extensible to encompass a broad spectrum of applications and cases and it is scalable to increasingly bigger configurations, supporting high-performance computing solutions;

(iv) the methodology can classify 2000×2000 pixel images ‘real time’ ($\sim 0.1 \text{ s image}^{-1}$) on a state-of-the-art GPU;

(v) public availability of a data set composed by hundreds of images generated from cosmological numerical simulations mimicking real radio observations. The data sets will be progressively extended in order to include more and more sophisticated images.

The methodology will be further developed in order to be ready for real observations, addressing in particular ASKAP data as a test-bed for the even larger challenge posed by the Square Kilometer Array. Development will progressively extend to increasingly complex and realistic images, e.g. including image processing arte-

facts like secondary radio lobes, remaining point-like sources and confusion noise.

ACKNOWLEDGEMENTS

We thank Tim Dettmers for the outstanding help and support at the beginning of the work, Baerbel Koribalski for the useful discussion and suggestions and Tim Dykes for the critical reading of the paper. We acknowledge useful feedback on the manuscript by V. Luckic and M. Brüggem. FV acknowledges financial support from the ERC Starting Grant ‘MAGCOW’, no. 714196. AB acknowledges support from the ERC Starting Grant ‘DRANOEL’, no. 714245. We acknowledge the usage of computational resources on the Piz-Daint supercluster at CSCS-ETHZ (Lugano, Switzerland) under projects s701 and s805.

REFERENCES

Abadi M. et al., 2015, TensorFlow: Large-scale Machine Learning on Heterogeneous Systems. Paper and Software available from <https://www.tensorflow.org/>

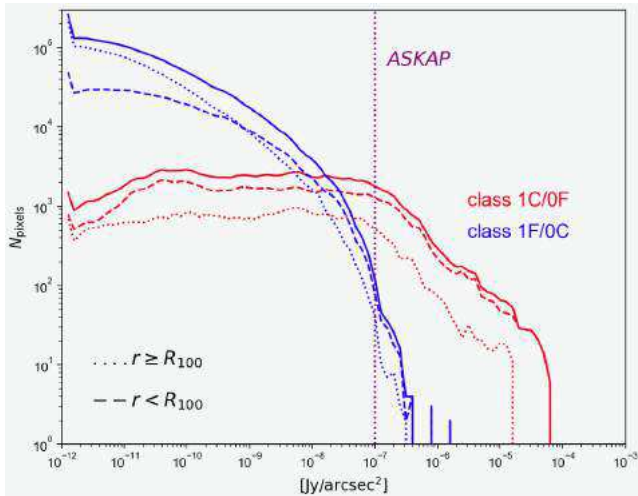

Figure 11. Flux distribution in a sample 2000×2000 pixel image, considering a $F_{\text{th}} = 0.75 \times 10^{-7} \text{ Jy arcsec}^{-2}$ threshold and $N_{\text{pix}} = 9$. The dashed lines give the distribution from pixels within the virial volume of clusters, while the dotted lines are for pixels located outside the virial region of clusters. The solid line is the sum of the two. The dotted vertical line gives the predicted rms noise of ASKAP.

- Abraham S, Aniyani A. K., Kembhavi A. K., Philip N. S., Vaghmare K., 2018, *MNRAS*, 477, 894
- Aniyani A. K., Thorat K., 2017, *ApJS*, 230, 20
- Barchi P. H., da Costa F. G., Sautter R., Moura T. C., Stalder D. H., Rosa R. R., de Carvalho R. R., 2017, preprint ([arXiv:1705.06818](https://arxiv.org/abs/1705.06818))
- Beck M. R. et al., 2018, *MNRAS*, 476, 5516
- Brown S. D., 2011, *J. Astrophys. Astron.*, 32, 577
- Bryan G. L. et al., 2014, *ApJS*, 211, 19
- Connor L., van Leeuwen J., 2018, preprint ([arXiv:1803.03084](https://arxiv.org/abs/1803.03084))
- Garcia-Garcia A., Orts-Escolano S., Oprea S. O., Villena-Martinez V., Garcia-Rodriguez J., 2017, preprint ([arXiv:1704.06857](https://arxiv.org/abs/1704.06857))
- Gheller C., Vazza F., Brüggén M., Alpaslan M., Holwerda B. W., Hopkins A. M., Liske J., 2016, *MNRAS*, 462, 448
- Gieseke F. et al., 2017, *MNRAS*, 472, 3101
- Grobler T. L., Nunhokee C. D., Smirnov O. M., van Zyl A. J., de Bruyn A. G., 2014, *MNRAS*, 439, 4030
- Hassan S., Liu A., Kohn S., Aguirre J. E., La Plante P., Lidz A., 2018 *Peering Toward Cosmic Dawn, Proceedings of the International Astronomical Union, IAU Symposium*, 333, 47

- He K., Zhang X., Ren S., Sun J., 2016, in *CVPR*, IEEE Computer Society, p. 770
- Herbel J., Kacprzak T., Amara A., Refregier A., Lucchi A., 2018, *Journal of Cosmology and Astroparticle Physics*, 7
- Heywood I. et al., 2016, *MNRAS*, 457, 4160
- Hoeft M., Brüggén M., 2007, *MNRAS*, 375, 77
- Johnston S. et al., 2008, *Exp. Astron.*, 22, 151
- Kremer J., Stensbo-Smidt K., Gieseke F., Pedersen K. S., Igel C., 2017, *IEEE Intel. Sys.*, 32, 16
- Krizhevsky A., Sutskever I., Hinton G. E., 2012, in Pereira F., Burges C. J. C., Bottou L., Weinberger K. Q., eds, *Advances in Neural Information Processing Systems 25*, Curran Associates, Inc., Red Hook, NY, USA, p. 1097
- Lecun Y., Bottou L., Bengio Y., Haffner P., 1998, *Proc. IEEE*, 86, 2278
- Lucie-Smith L., Peiris H. V., Pontzen A., Lochner M., 2018, *MNRAS*, 479, 3405
- Lukic V., Brüggén M., Banfield J. K., Wong O. I., Rudnick L., Norris R. P., Simmons B., 2018, *MNRAS*, 476, 246
- Ball N. M., Brunner R. J., 2009, *Int. J. Modern Phys. D*, 19, 1049
- Mahabal A., Sheth K., Gieseke F., Pai A., Djorgovski S. G., Drake A., Graham M., 2017, *The CSS/CRTS/PTF Collaboration*, preprint ([arXiv:1709.06257](https://arxiv.org/abs/1709.06257))
- Nieto D., Brill A., Kim B., Humensky T. B., 2017, *Cherenkov Telescope Array f. t.*, preprint ([arXiv:1709.05889](https://arxiv.org/abs/1709.05889))
- Parks D., Prochaska J. X., Dong S., Cai Z., 2018, *MNRAS*, 476, 1151
- Planck Collaboration et al., 2014, *Planck 2013 results. XVI. Cosmological parameters*, *A&A*, 594, A16
- Rodríguez A. C., Kacprzak T., Lucchi A., Amara A., Sgier R., Fluri J., Hofmann T., Réfrégier A., 2018, preprint ([arXiv:1801.09070](https://arxiv.org/abs/1801.09070))
- Schmelzle J., Lucchi A., Kacprzak T., Amara A., Sgier R., Réfrégier A., Hofmann T., 2017, preprint ([arXiv:1707.05167](https://arxiv.org/abs/1707.05167))
- Serra P. et al., 2015, *MNRAS*, 452, 2680
- Shi S., Chu X., 2017, preprint ([arXiv:1711.05979](https://arxiv.org/abs/1711.05979))
- Simonyan K., Zisserman A., 2014, *CoRR*, abs ([arXiv 1409.1556](https://arxiv.org/abs/1409.1556))
- Sullivan D., Iliev I. T., Dixon K. L., 2018, *MNRAS*, 473, 38
- Szegedy C. et al., 2015, in *Computer Vision and Pattern Recognition (CVPR)*
- Vazza F., Brüggén M., Gheller C., Wang P., 2014, *MNRAS*, 445, 3706
- Vazza F., Ferrari C., Brüggén M., Bonafede A., Gheller C., Wang P., 2015, *A&A*, 580, A119
- Vazza F., Brüggén M., Gheller C., Hackstein S., Wittor D., Hinz P. M., 2017, *Class. Quant. Gravity*, 34, 234001

This paper has been typeset from a $\text{\TeX}/\text{\LaTeX}$ file prepared by the author.