



ALMA MATER STUDIORUM
UNIVERSITÀ DI BOLOGNA

ARCHIVIO ISTITUZIONALE
DELLA RICERCA

Alma Mater Studiorum Università di Bologna Archivio istituzionale della ricerca

Testing of the ITER CS Module #4

This is the final peer-reviewed author's accepted manuscript (postprint) of the following publication:

Published Version:

Martovetsky N., Freudenberg K., Rossano G., Wooley K., Khumthong K., Norauskys N., et al. (2024). Testing of the ITER CS Module #4. IEEE TRANSACTIONS ON APPLIED SUPERCONDUCTIVITY, 34(5), 1-6 [10.1109/TASC.2023.3339075].

Availability:

This version is available at: <https://hdl.handle.net/11585/961941> since: 2024-07-08

Published:

DOI: <http://doi.org/10.1109/TASC.2023.3339075>

Terms of use:

Some rights reserved. The terms and conditions for the reuse of this version of the manuscript are specified in the publishing policy. For all terms of use and more information see the publisher's website.

This item was downloaded from IRIS Università di Bologna (<https://cris.unibo.it/>).
When citing, please refer to the published version.

(Article begins on next page)

17 August 2024

Testing of the ITER CS Module #4

Nicolai Martovetsky, Kevin Freudenberg, Graham Rossano, Kyle Wooley, Kenneth Khumthong, Nikolai Norausky, Ed Ortiz, Jeffery Sheeron, John Smith, Roberto Bonifetto, *Member, IEEE*, Roberto Zanino, *Senior Member, IEEE*, Andrea Zappatore, *Associate Member, IEEE*, Thierry Schild, Yasuyuki Miyoshi, German Perez Pichel, Christine Hoa, Marco Breschi, *Senior Member, IEEE*, Lorenzo Cavallucci and Alan Langhorn

Abstract—The ITER Central Solenoid is under fabrication by the US ITER organization and its subcontractors. US ITER will supply seven modules to ITER IO, six of which will be assembled in a stack that forms the ITER Central Solenoid. All CS modules were or will be tested at 40 kA in the Final Test facility at General Atomics, Poway, CA.

Testing included high voltage, as well as Paschen testing in the vacuum and global leak tests before and after the cooldown to 4.5 K and EM cycling to 40 kA. In the paper we present the results of the CS Module 4 performance, after modifications to the test facility to improve reliability and instrumentation. We measured critical temperatures in several pancakes, AC losses before and after 10 cycles to 40 kA, joints resistance and hydraulic characteristics of the coils. We also measured displacements of the coil height and vertical strain of the CSM to verify structural mechanical characteristics of the coil along with cooldown shrinkage of the coil. We studied performance of the cowound quench detectors, confirmed their effectiveness in suppression of the inductive noise, but also developed a plan to improve sensitivity of the quench detection in ITER CS. This information is necessary for verification of the stack behavior of CS in ITER operation. The test results, preliminary analyses, comparisons to the other tested modules are presented and discussed.

Index Terms—AC Losses, Cable in Conduit Conductors, Central Solenoid, ITER project.

I. INTRODUCTION

THE US ITER Domestic Agency is responsible for supplying seven Central Solenoid Modules (CSM) to ITER collaboration. Six CSMs will be assembled in a CS stack which will be installed in the tokamak and the remaining module will be saved as a spare. To reduce the performance risks all modules are tested to 40 kA. The GA test facility has all necessary systems for performing cold tests – cryogenics, vacuum system, data acquisition, instrumentation, HTS current leads, 50 kA Power Supply, Switchyard, Quench Detection systems, control system and safety system [1]. Modules have slightly different test plans and instrumentation to optimize the testing procedures. We will describe the highlights of the test plan for CSM4 and main results. Some of the results of the CSM testing is presented in [2].

The manuscript is submitted for a review on September 11, 2023.
 N.M. is with Oak Ridge National Laboratory (ORNL), Oak Ridge, TN 37831 USA (nmk@ornl.gov)
 K.F. is with ORNL, (freudenbergk@ornl.gov)
 G.R. is with ORNL, (rossanog@ornl.gov)
 K.W. is with ORNL, (wooleykt@ornl.gov)
 K.K. is with General Atomics (GA), Poway, CA 92064 USA (Kenneth.Khumthong@ga.com)
 N.N. is with GA, (Nicolai.Norausky@ga.com)
 E.O. is with GA, (Ed.Ortiz@ga.com)
 Je.S. is with GA (Jeff.Sheeron@ga.com)
 Jo.S. is with GA (John.Smith@ga.com)

II. DIELECTRIC STRENGTH BEFORE COOLDOWN

Every CS module goes through a High Voltage (HV) testing at ambient pressure to 30 kV to ground and a Paschen testing to 15 kV to ground. The Paschen testing is performed at the decades of vacuum from 1e-4 mbar to 100 mbar in the test chamber equipped with the high-speed video cameras to detect the location of the breakdown if it takes place. These measurements are performed at room temperature before and after the cold testing of the module. If the module passes the high voltage tests before cold tests and fails the tests after cooldown, the repair is performed, and the module goes via one more cold cycle to 4 K and following HV testing to make sure that the repair is successful.

In addition, we measure resistance to ground with a Megaohm meter at many fabrication and testing steps to assure low leakage current from the module to ground, when HV is applied in operation.

III. INSTRUMENTATION OF THE CSM4

Instrumentation of the CSM4 is shown in Fig. 1, which shows the temperature sensors, and the voltage taps. Other sensors are not shown (like displacement sensors, pressure sensors, flowmeters, strain gauges, leakage current to ground). We have two separate amplifiers across some double pancakes (DPs). This is to measure signals which amplitude differs by about five orders of magnitude. One amplifier has a high gain to measure resistance of the joint (several microvolts), another one, assigned to measure inductive noise during dumps, has much higher signal, (several hundreds of millivolts), which needs much lower gain. That is why we used two separate amplifiers in parallel for the same signals in different conditions.

R. B. is with the NEMO Group, Dipartimento Energia, Politecnico di Torino, Italy (roberto.bonifetto@polito.it)
 R. Z. is with Polito (roberto.zanino@polito.it)
 A.Z. is with Polito (andrea.zappatore@polito.it)
 T.S. is with ITER International Organization (IO), 13067 St. Paul-lez-Durance France (thierry.schild@iter.org)
 Y.S. is with ITER IO (Yasuuki.Miyoshi@iter.org)
 G.PP. is with ITER IO (German.PerezPichel@iter.org)
 C.H. is with ITER IO (Christine.Hoa@iter.org)
 M.B. is with University of Bologna, Italy (marco.breschi@unibo.it)
 L.C. is with University of Bologna (lorenzo.cavallucci@unibo.it)
 A.L. is with Startech Inc., Solana Beach, CA 92075 USA (Alan@stcryo.com)

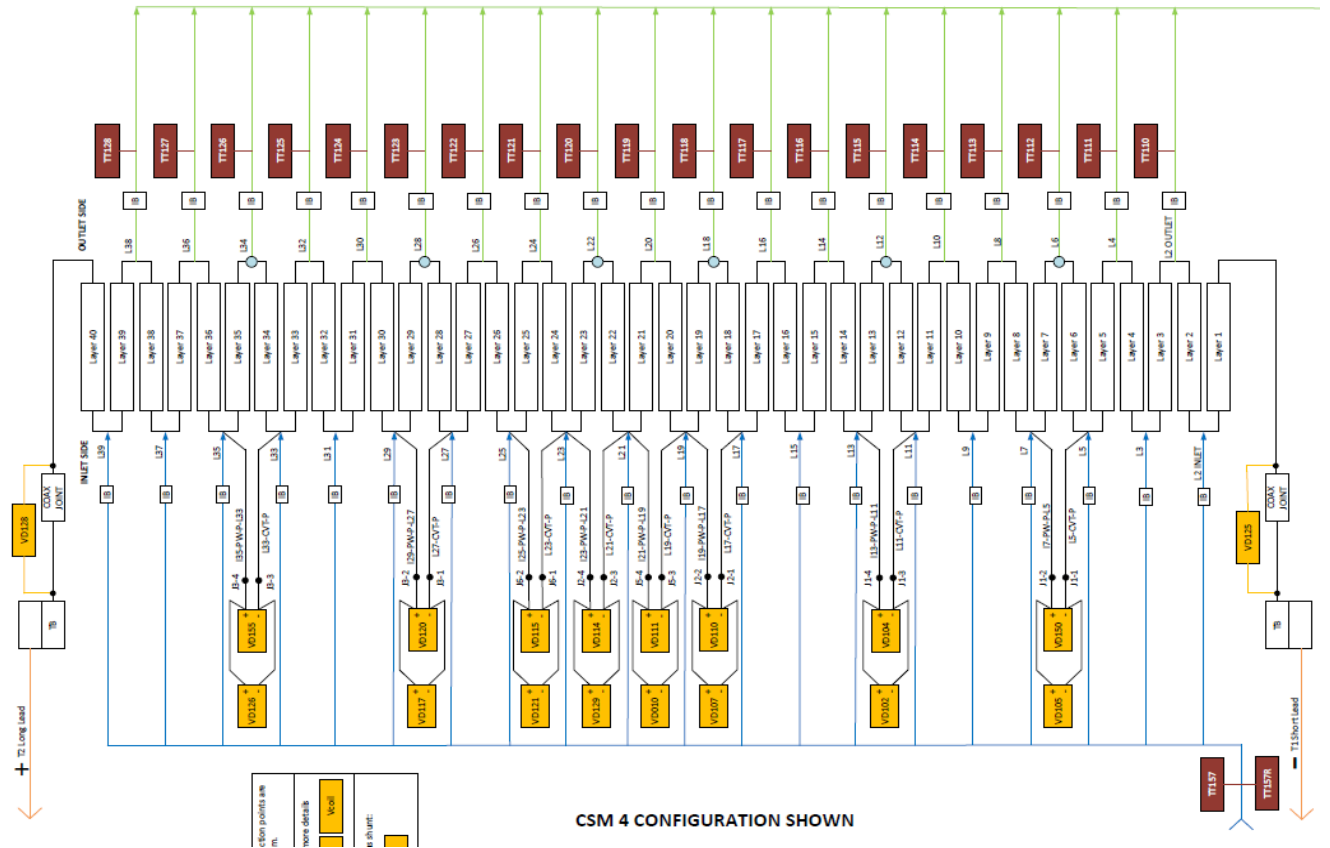

Fig. 1. CSM4 instrumentation.

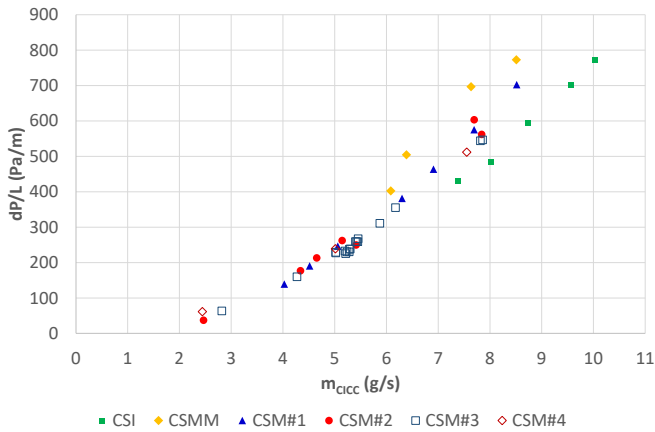

Fig. 2. Hydraulic impedance of the coils with the ITER CS conductors.

IV. COOLDOWN AND WARM UP

CSM4 was thermo-cycled twice all the way to 4.5 K. The first cycle was done to test the effect of cooldown on dielectric strength of the CSM4.

The second cooldown was for full scale cold testing with currents up to 40 kA.

The cooldown of the CSM4 was done with two constraints: 1) the temperature gradient between the inlet and outlet should not exceed 50 K and 2) the rate of cooling should not exceed 1 K/h. These constraints are valid only when the module is above 77 K, after that the rate of cooling is unlimited due to a small

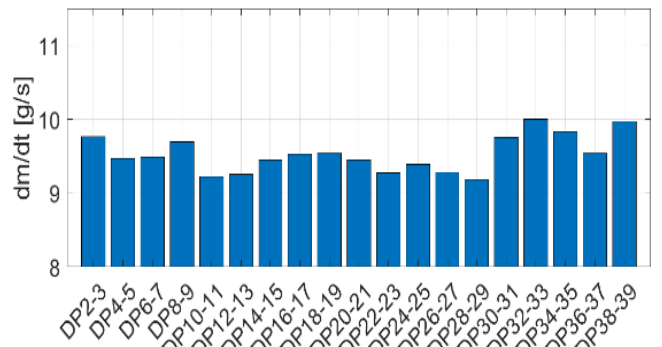

Fig. 3. Mass flow in the DPs of CSM4 at average flow of 5 g/s per pancake

shrinkage after that. During cooldown we experienced a blockage of the filter which presumably was caused by freezing impurities in the filter designed to stop foreign particles. Residual gas analyzer did not detect any impurities. Warming up to 130 K removed the plug, which is typical for frozen gases.

We measured the temperature of the transition into the normal state and found that they are 16.6-16.8 K before the current charging of the CSM4; after the cycles it showed 16.5-16.8 K which represents an insignificant change, considering that the rate of cooling is difficult to reproduce precisely.

That shows that the fabrication process did not degrade the conductor properties, although T_c measurements control only the conductor properties at the outlets.

V. THERMAL HYDRAULIC CHARACTERISTICS

During these tests we measured hydraulic impedance, distribution of the flow among the parallel channels. Helium is injected from the ID in 20 double pancakes (DPs), and it exits from 19 outlets and the outmost pancakes through the terminations.

Fig. 2 shows hydraulic impedance of the ITER CS conductors in different coils made with similar conductors. CSI- a qualification insert tested in 2015, CSMM is the CS Mockup Module, tested in 2018. As we can see the scatter is relatively low, the pressure drop is consistent.

Fig. 3 shows a mass flow distribution through the coil DPs. The CSM has 20 DPs and they are equipped with the inlet and outlet temperature sensors that allow to detect a time of flight in different pancakes.

Steady state heat loads on the CSM4 were measured to be about 20 W, which is sufficiently low, although far from the best thermally insulated magnets. The CSM4 in GA facility has only MLI thermal insulation, no LN2 cooled shields.

VI. RESISTANCE OF THE JOINTS

ITER CSM (central solenoid module) uses 7 pieces of the conductor connected by interpancake joints (called sintered or splice joints). There are also termination joints, which are called coaxial joints. These joints are deliverables to ITER IO only as terminations attached to the CSM. They will be connected to bus extensions, also supplied to IO by US ITER with the assembly parts.

There is a third type of joints in the facility -twin box joints. Fig. 4 also shows twin box joint to the feeders for the CS3U. Twin box joints are also present in the GA feeders. They are not deliverables to ITER. The twin box joints that

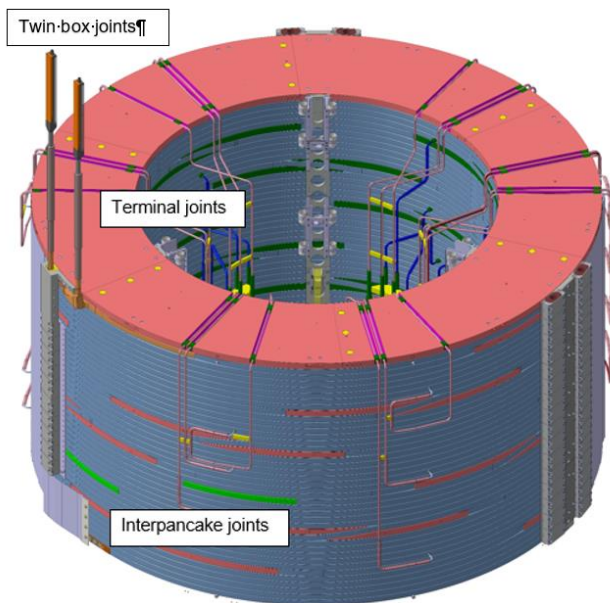

Fig. 4. CSM and location of the terminal joints and interpancake joints

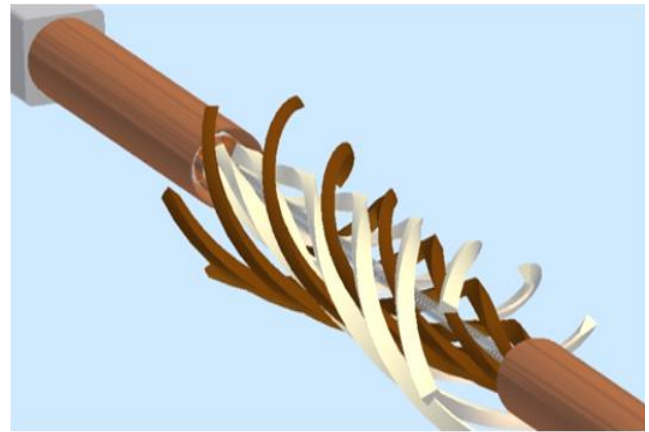

Fig. 5. Interpancake sintered joint schematic

US ITER supplies to ITER IO are attached to the buses from the coaxial joints to the feeders. They are not cold tested, but identical joints were tested in SULTAN facility and showed very good performance, low losses and low DC resistance (less than 2 nOhms). There is a high confidence that the twin box joints will operate as expected.

The GA facility has a similar twin box joints in the feeders, which resistance is also monitored. These twin box joints have NbTi cables in contrast to the twin boxes on the buses to the feeders (Nb3Sn). Usually, NbTi twin box joints have a little higher resistance than Nb3Sn joints.

Thus, there are two types of the joints with high interest: six interpancake joints and two termination joints (coaxial) per CSM. The coaxial joints in their final configuration will be assembled on the ITER assembly site. US ITER provides the coaxial joint parts and ITER IO established and qualified the assembly.

The ITER requirements specify resistance of the joints to be lower than 4.1 nOhms, but the operation is possible with resistance up to 20 nOhms. We measured resistance of the interpancake joints by electrical methods using cowound voltage taps that provided pretty good signals with high suppression of



Fig. 6. Configuration of the coaxial joint and parts. Disassembly of the joint (left) and the joint parts(right). Three triads and two terminations pointing at each other are shown. Smashed indium wires are seen on the interfaces.

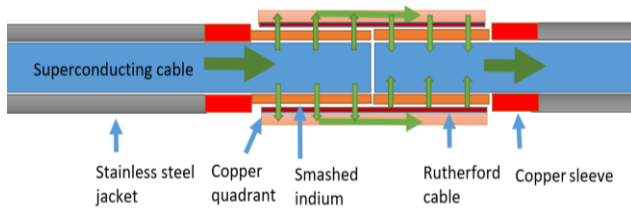

Fig. 7. Current transfer schematic in the coaxial joint

the noise, which is required for accurate assessments of the joint resistance. The other joints were measured by the usual voltage taps across the joints.

Schematic of the sintered joints is shown in Fig. 5.

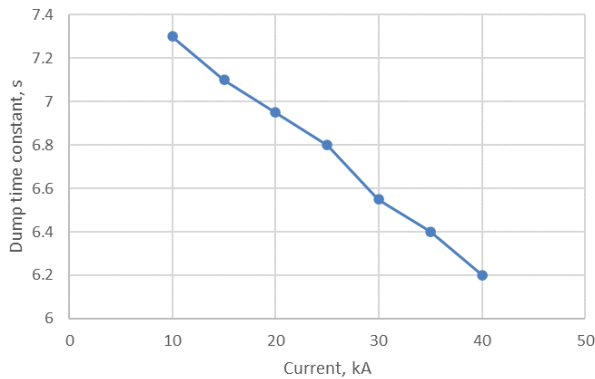

Fig. 8. Decay time of dumps vs initial current

The joints are made by cutting selected subcables from both sides of the connecting cables, preserving space allocation of the regular cable. Thus, the joints are not sensitive to the exact location, occupy the space of a regular conductor and do not require assembly or maintenance after assembly. The current carrying capacity is more than adequate for operation in ITER, the current sharing temperature at 40 kA and in 4 T exceeds 10.5 K, as it was measured in SULTAN tests. This gives a very high margin for the sintered joint.

The coaxial joint in the CSM testing at GA is like the final configuration in ITER with some differences. Fig. 6 shows the coaxial joint arrangement and main parts.

The current transfer schematic in the coaxial joint is shown in Fig. 7. The current in the joint is transferred via copper quadrant with soldered in superconducting Rutherford cables. The low resistivity contact between the termination and the quadrant is achieved by smashed Indium wires. More details on the CS joints could be found in [1].

Resistance of the sintered joints is very low; the highest resistance measured at 40 kA was 0.125 nOhm. Coaxial joints had resistances 11 and 18 nOhms, but most of the resistance came from the feeders, which was measured in the previous tests with internal voltage taps, so the joints assembled at ITER assembly site will have a significantly lower resistance. The twin box resistances in the GA facility showed 3.1 and 3.5 nOhm.

VII. AC LOSSES IN CSM4

In the current dump tests, the current was ramped linearly to the target value (from 5 to 40 kA), then the target value was hold for ~1000 s to let the outlet helium temperature stabilize

and then an exponential current dump was initiated, discharging the current on the resistor bank. Two different (nominal) current discharge time constants were tested: 7.8 s and 23 s. The actual value of the time constants can change due to the change in the value of the resistance of the resistor bank, due to, e.g., heating of the resistors and eddy current losses in the supporting structures.

Discharge of the current in the ideal L-R circuit is exponential, but in our testing the decay time constant varies with amplitude of the current, shown in Fig. 8.

In case of current dumps from 25 kA (included) or higher, the coil was isolated from the circulator to prevent a high pulsed load on the cryoplant. This procedure is like that already

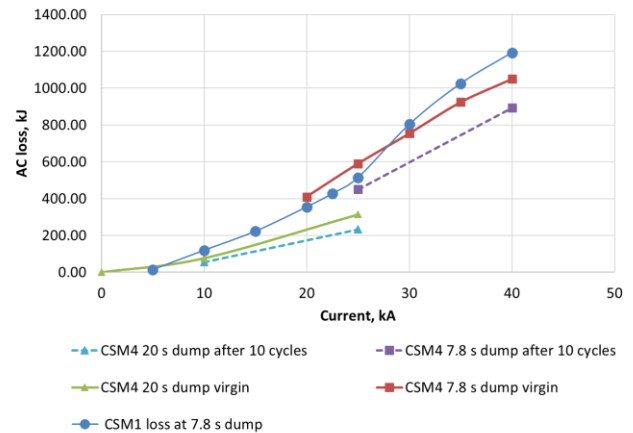

Fig. 9. AC losses in CSM4 by isochoric method

adopted for CSM1 [3] and CSM2 **Error! Reference source not found.**

The AC losses in the CSM have two components – hysteresis losses and coupling losses. Hysteresis losses were measured in slow charge-discharge cycles and were calculated for the fast dumps.

Fig. 9 shows results of the CSM4 AC loss before cycles at nominal dumps of 7.8 s and comparison with the CSM1 module, which had the same type of the strand (JASTEK). AC losses were evaluated by isochoric method.

Fig. 9 shows a slight reduction of the losses after EM cycles. This phenomenon is well known and is associated with breaking some sintering links among the strands in the cable under cyclic electromagnetic loading of the cable. Most of the losses drop takes place after the first 50-100 cycles, then the loss saturates. It was first observed in a big magnet and reported in [4].

The AC loss assessment in CSM4 by isochoric and by calorimetry methods will be presented and discussed at this conference in details [6].

The AC loss measurements show that the amount of energy is quite manageable by the module and will not cause a concern in ITER operation. In ITER operation the amplitude of the dump is slightly more than 1 T as opposed to the tests in GA where the ID of the coil sees above 8 T dump.

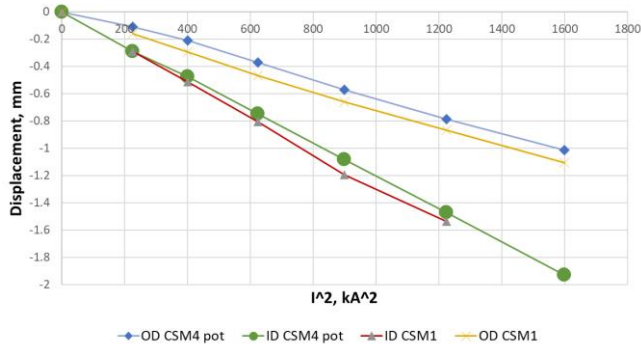

Fig.10. CSM4 displacement vs square of current. Comparison of CSM4 with CSM1

VIII. MECHANICAL PROPERTIES OF THE CSM4

ITER CS is a stack of 6 modules more than 13 m tall. It is held together by a precompression system. In ITER scenario the CSM experience a very high compression and separating forces between the lower module and the rest of the stack. It is critical to keep the stack compressed all the time to prevent appearance of the gaps between modules and unacceptable shear forces.

To reliably predict behavior of the stack we paid high attention to characterizing the mechanical behavior of the modules. The main parameters of interest are: a) thermal shrinking during cooldown from room temperature to 4.5 K; b) stiffness of the CSM (Young modulus); c) dependence of stiffness versus applied load.

We also measured vertical strain to support the displacement measurements using long base strain gauges at the ID and OD of the CSM4.

Since mechanical properties of the coil have very high importance, we started obtaining the properties on the models of the winding packs on 4x4 arrays of the conductor with the same insulation and epoxy impregnation. Preliminary data obtained on the samples in the press at 77 K showed that the Young modulus strongly depends on the load and comes to saturation at the compressive loads of 30-40 MPa.

The displacement sensors instrumentation consisted of three devices at the ID and three at the OD of the CSM. There was redundancy in the displacement devices: each has two sensors – one based on a potentiometer and another one based on the extensometer with full bridge of strain gauges. The sensors were proven to be compensated to cancel effects of the temperature and the magnetic field. All sensors were calibrated before cooldown.

Fig. 10 shows the following features:

- 1) Young modulus does not depend on the load.
- 2) Young modulus is within 32-36 GPa, noticeably lower than what was measured on the arrays in the press.
- 3) Thermal shrinking in CSM4 is consistent with other modules and represents about 0.3% for cooldown from RT to 4.5 K.

These conclusions support our observations from previous tests of the modules. Only the third feature was fully expected. The mockups showed stiffness from 45 to 53 GPa at high loads

and low stiffness at low loads, in contrast to what we saw in CSM4 behavior.

These data may result in some adjustments in the CS stack preload.

IX. INDUCTIVE NOISE CANCELLATION BY THE COWOUND VOLTAGE TAPS

Quick and reliable detection of the normal zone appearance in the magnet is of the paramount importance. Failure to evacuate the stored energy from the magnet will lead to very dangerous consequences. Quench detection (QD) system has high redundancy and required a demonstration of the effective suppression of the inductive noise in conditions of high dB/dt.

The highlights of the quench detection are:

- The quench detection system needs to detect appearance of the normal zone at any point in the operating scenario, including plasma initiation and plasma disruption.
- In modelling it was established that the initiation is the most disturbing event from the inductive noise.
- To detect an appearance of the normal zone in CSM we need to suppress the electromagnetic (EM) noise to a S/N ratio 5 or better.
- Threshold of a quench is 300 mV in ITER CS (65 mV in CSM at GA testing).
- We need to suppress the noise to a level of 60 mV or better.
- It is acceptable to have the noise a few hundreds of ms above that, ITER delay time is up to 1.5 s, at GA facility – 0.7 s.
- We will use CSM dumps to see how well we can suppress the inductive noise, which is comparable to ignition in dB/dt.

During dumps from 40 kA, the magnetic field change exceeds 1.4 T/s, which is even a little higher than the dB/dt at plasma initiation in ITER CS.

To suppress the inductive noise, we use cowound wires, which are wrapped around the conductor. Such a schematic provides very efficient cancellation of the inductive signal from outside source of the dB/dt, the main source of the inductive noise [7].

This inductive noise in the cowound sensor is well compensated from all sources except the self-current, since there is an uncompensated flux between the conductor center and the sensor outside the jacket.

Fig. 11 shows the principle of the inductive noise cancellation.

It is inevitable and cannot be canceled if the cowound sensor is outside the conductor. This inductive noise cannot be ignored, since it represents about 400 mV per DP. In order to cancel this signal, we will subtract the signals from one DP from another. In this case, the inductive noise is cancelled, and the normal zone signal remains detected.

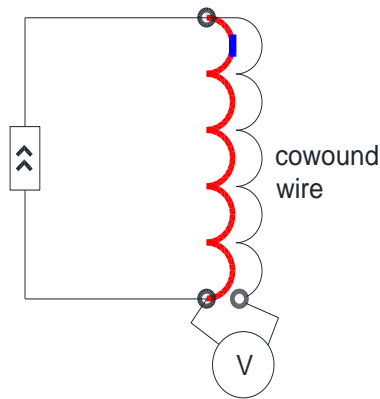

Fig. 11. Cowound wire QD system

Details of the inductive noise will be presented in a separate paper [8]. Here we will give a summary of our findings.

A typical shape of the cancelled signal is shown in Fig. 12, which is a subtraction of VD102 signal from VD105. The signals are shown in Fig. 12.

As we can see the signal has an amplitude of 180 mV, which is higher than desired 60 mV, but the signal exists about 0.2 s, which with our delay time of 1.5 s will not trigger the quench protection circuit. Thus, despite exceeding the amplitude, the inductive noise cancellation will allow a reliable quench detection.

We checked several possibilities about why the noise rejection did not give us a low amplitude noise. If the inductive noise signals would be proportional to the dI/dt in the coil, the noise rejection would have been more successful.

The hypothesis we are considering:

- 1) Slow data acquisition, which does not allow to synchronize the signals in the DPs.
- 2) Stray capacitance that distorts the electrical signals between different DPs
- 3) Eddy currents in the passive structures, which have different coupling with cowound sensors in different DPs.

We will run some tests in order to reveal the reasons of the lower than expected cancellation of the inductive noise.

ITER DAQ will allow the real time processing and that shall improve the noise cancellation and provide a higher level of reliability.

As a summary, the QD system is meeting the requirements of a reliable detection of the normal zone as is, but there is a room for improvement.

X. CONCLUSION

CSM4 went through a thorough testing at GA facility and demonstrated that the CSM4 is fit for service in ITER CS with no limitations. We obtained very valuable information, which will be used for operation of CS modules in ITER machine.

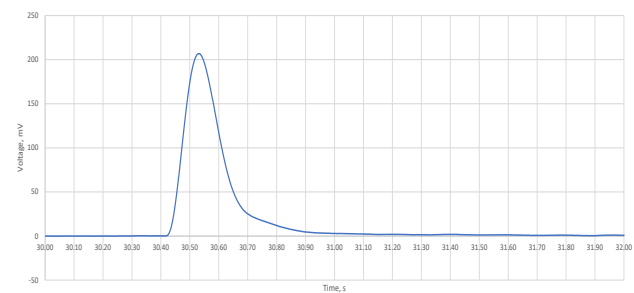

Fig. 12. Inductive noise from a difference of two DPs – VD105 and VD102

ACKNOWLEDGMENT

This manuscript has been authored by UT-Battelle, LLC under Contract No. DE-AC05-00OR22725 with the U.S. Department of Energy. The United States Government retains and the publisher, by accepting the article for publication, acknowledges that the United States Government retains a non-exclusive, paid-up, irrevocable, world-wide license to publish or reproduce the published form of this manuscript, or allow others to do so, for United States Government purposes. The Department of Energy will provide public access to these results of federally sponsored research in accordance with the DOE Public Access Plan (<http://energy.gov/downloads/doe-public-access-plan>).

Disclaimer: The views and opinions expressed herein do not necessarily reflect those of the ITER Organization or of the European Commission.

REFERENCES

- [1] K. Schaubel, A. Langhorn, S. Lloyd, Z. Picc, E. Salazar, and J. Smith, "The ITER central solenoid module final test facility," *Fusion Eng. Des.*, vol. 124, pp. 59–63, 2017
- [2] Nicolai Martovetsky, Kevin Freudenberg, Graham Rossano et al Testing of the ITER Central Solenoid, *IEEE Trans. Plasma Science*, vol.: 50, Issue: 11, November 2022
- [3] M. Breschi, L. Cavallucci, P.L. Ribani, R. Bonifetto, A. Zappatore, R. Zanino, F. Gauthier, P. Bauer, N. Martovetsky, "AC Losses in the First ITER CS Module Tests: Experimental Results and Comparison to Analytical Models", *IEEE Trans. Appl. Supercond.* vol. 31 N5, 2021.
- [4] M. Breschi,, L. Cavallucci, P. Bauer, F. Gauthier, R. Bonifetto, A. Zappatore, R. Zanino, N. Martovetsky, K. Khumthong, E. Ortiz, J. Sheeron, "AC losses in the second module of the ITER Central Solenoid", *IEEE Trans. Appl. Supercond.* v. 32, N 6, 2022
- [5] N. Martovetsky, P. Michael, J. Minervini, et al, ITER CS Model Coil and CS Insert Test Results, *IEEE Trans. Appl. Supercond.*, v.11, N1, March 2001, p.2030-2033
- [6] M. Breschi, L. Cavallucci, P. Bauer A. Vostner, R. Bonifetto, R. Zanino, A. Zappatore, N. Martovetsky, Coupling and hysteresis loss measurement on the ITER CS Module #4, this conference.
- [7] N. Martovetsky and M. R. Chaplin, Co-wound voltage sensor R&D for TPX Magnets, Proceedings of 16th SOFE Conference, Sept 30-Oct. 5, 1995, p.1534-1537
- [8] Nicolai Martovetsky, Kenneth Khumthong, Edward Ortiz, Jeffery Sheeron, "Inductive Noise Suppression in Quench Detection Circuits of ITER Central Solenoid", this conference