

ALMA MATER STUDIORUM – UNIVERSITÀ DI BOLOGNA

THE OTTOMAN BRIDGE OF MOSUL:
SURVEY AND HISTORY OF
AN ENDANGERED HERITAGE

by

NICOLÒ MARCHETTI, RWAED MUWAFaq MOHAMMED, CRISTIANO PUTZOLU,
JULIAN EDGEWORTH READE, MARCO VALERI

MAIOP Mesopotamian Archaeological Initiative Occasional Papers 2023:1
Iraqi-Italian Archaeological Expedition to Nineveh and Dur-Kurigalzu

Editor: Nicolò Marchetti
Editorial staff: Cristiano Putzolu

www.orientlab.net/pubs

Text and images are licensed under the Creative Commons Attribution CC BY-NC-SA 4.0 of the Authors and Ante Quem S.r.l., if not credited otherwise.

Published by Ante Quem S.r.l. and Department of History and Cultures - University of Bologna
Via Senzanome 10, 40123 Bologna – tel. and fax +39 051 4211109, www.antequem.it
Printed in December 2023

ISBN 978-88-7849-192-2
ISSN
doi 10.12877/maiop202301

THE OTTOMAN BRIDGE OF MOSUL: SURVEY AND HISTORY OF AN ENDANGERED HERITAGE

1. INTRODUCTION (*NM*)

While we were carrying out the Iraqi-Italian QADIS survey project in the south of Iraq (Marchetti and Zaina 2020), the State Board of Antiquities and Heritage asked us for help in protecting and developing the immense site of Nineveh, ever more endangered by urban encroachment after its liberation from Daesh in June 2017. A preliminary survey was thus carried out in January 2019 and then, since the autumn of that same year, yearly campaigns of archaeological excavations and conservation have followed, until during the 5th campaign of 2023 the first part of the archaeological park of Nineveh was completed and opened to the public. We have applied an integrated approach aiming at setting the site in both its historical and urban contexts, with the goals of understanding how an imperial capital city functioned, but also how the modern urban identity of Mosul has been constructed in relation to its glorious and vast heritage, with a view to assuring its conservation and protection.

Our Iraqi-Italian Archaeological Expedition to Nineveh by the University of Bologna and the Iraqi State Board of Antiquities and Heritage (hereafter SBAH), directed by Nicolò Marchetti, has been funded by that University and by the Italian Ministry of Foreign Affairs and International Cooperation, benefitting as well from conservation grants by the J. M. Kaplan Fund and the Volkswagen Foundation in order to tackle the complex task

of reintegrating the torn fabrics of society and heritage in a city devastated by war, civil strife and ideological clashes¹.

Our approach thus brought us into contact with different priorities of different subjects, both public at international, State and local level, and private ones: besides Nineveh, it was the urban fabric of the Old City of Mosul which has attracted the most attention, with UNESCO being the most visible actor there. At the same time, many other landmark features remained neglected, such as the historical material connection between the two banks of the river, represented by the Old Bridge of Mosul made with mostly reemployed 7th century BCE ashlar: in fact, it was not only ignored but actually significantly endangered by new public works. We thus deemed it necessary to carry out there a salvage documentation operation in July 2022, as well as providing an historical context to that monument, on both of which aspects we report below.

¹ In addition to our sponsors, we extend our thanks also to several people and institutions, since without their support we would not have succeeded in achieving several of our goals. In Mosul, our scientific partner Heireddin Ahmed, SBAH Inspector of Ninawa, has been a constant mentor; the Governor of Ninawa, Najim Al Jibouri, has greatly supported conservation actions by SBAH; Abdelsitar Habo, the Mayor of Mosul, has come to cooperate fully with archaeologists in managing and integrating heritage within the Municipality's urban masterplan; the colleagues of the College of Archaeology of the University of Mosul, foremost among them Khalid Salim Ismael, have always encouraged us and provided many important contacts. In Baghdad, the Iraqi Ministry of Culture, Tourism and Antiquities and the SBAH, with its then President Laith Hussein, the Director General of Excavations and Researches Ali Shalgham, the Director of Excavations Souheil Tmimi and the Director of GIS Riyadh Hatem have always fully supported us; Maurizio Greganti, Ambassador of Italy to Iraq, has never failed to show his enthusiasm in fostering cultural bilateral relations, as also did Alessandro Mignini and Chiara Franchini at the Italian Embassy. In Rome, the successive Ambassadors of Iraq to Italy, first Safia Al Souhail and now Saywan Barzani, showed us their keenest interest in every possible way; at the DGDP of the Ministry of Foreign Affairs and International Cooperation, the Director General Alessandro De Pedys, the head of the 6th Office, Paolo Andrea Bartorelli, and his staff have always extended us their full trust. At the University of Bologna, the head of the Department of History and Cultures, Francesca Sofia, and its chief administrative officer, Maria Carmela Cucurachi, have greatly eased the management of our overseas project; the past rector Francesco Ubertini believed in this joint initiative from the very beginning. To all of the above, to many other colleagues, authorities and friends who could not all be mentioned here and to the Iraqi forces who took care of our security in the field we would like to express our enduring gratitude. Images are the copyright of the Iraqi-Italian Expedition at Nineveh, unless credited otherwise.

2. AN ARCHITECTURAL SURVEY AND ANALYSIS OF THE OLD BRIDGE

2.1. *Methodological Framework (CP, MV)*

The topographic survey of the Ottoman “Old Bridge” in Mosul can be considered as an example of the use of digital methodologies for spatial data acquisition in archaeology (Fig. 1, Pl. I.1). The use of sfm photogrammetry for surveying archaeological stratigraphy and architecture is now considered an established procedure in the field of high-density surveying and measurement (HDSM) (Opitz and Limp 2015). The output of this survey method consists of point clouds of millions of x,y,z coordinates that are then transformed into textured three-dimensional surfaces that allow for an accurate topographical reconstitution of the surveyed contexts in a GIS environment.

Although it has recently been rightly pointed out that “Although the term “3D GIS” has been in use since the early 1990s [...] today we are still far from reaching the full potential of 3D GIS” (Dell’Unto and Landeschi 2022: 29; see also Merlo 2016: 151; van Leusen and Nobles 2018: 471), the possibility of having an accurate three-dimensional model that can be used to generate a 2.5D raster on which to vectorise the various details of a plan over areas of up to several hundred square metres should not be underestimated (Dell’Unto and Landeschi 2022: 61).

The adoption in archaeological surveying of fully digital methodologies, instruments, procedures and outputs constitutes the paradigm shift which Kristiansen (2014) questioned in the very title of one of his papers a few years ago. The “Paradigm shift” is instead explicitly recognised by Reflexive Archaeology (Roosevelt et al. 2015; Boyd et al. 2021).

Although used in combination with Laser Scanner surveying in many recent projects (Berggren et al. 2015; Boyd et al. 2021), in archaeological research sfm photogrammetry is more often considered an alternative to the more expensive (both in terms of economic resources needed to purchase the instrumentation and train personnel, and in terms of time needed for acquisition and processing) laser scanning (Dell’Unto et al. 2017; Putzolu et al. in press): while accuracy is certainly higher with the latter, the greater speed of acquisition, thanks in part to the use of UAVs, and the relative ease of data processing have in fact made sfm photogrammetry the low-cost solution for an accurate 3D survey of

archaeological features from small object to landscape scale (Willis et al. 2016; Wilkinson et al. 2016; Bosco 2022).

The use of drones, which have become much more accessible in recent years, and the advancement of flight planning and mapping software, has made photogrammetry affordable for everyone, streamlining the acquisition and processing of photos, and obtaining less redundant results. In addition, the use of increasingly smart GNSS systems has helped shorten acquisition times and improved the spatial accuracy of the final results. Moreover, recently integrated GNSS-UAV systems are now allowing drones to take georeferenced photos with very high accuracy that makes the creation of ground control points virtually unnecessary and makes the software procedure of photo processing even faster and more automated.

The presence of the flowing water of the Tigris negatively affected automatic flight planning. In some cases, documented on specific forums, it has been observed that, when small drones equipped with downward proximity sensors are flown a few metres from the water, the flight system can go into a tailspin, with the risk of the drone crashing. This seems to be due to the refraction of water that is not read correctly by the sensors themselves.

This consideration, and the natural distortion of the water, which jeopardised the accuracy of the data, made us discard the idea of creating a precision map of submerged structures as well (Benjamin et al. 2019; Skarlatos and Savvidou 2015).

2.2. The survey of the bridge: analysis of the plan (NM, RMM, CP, MV)

After an initial photographic survey (4th July 2022), the operations of the field survey saw the authors engaged on site for two half-days:

- during the first one (7th July 2022), a series of ground control points were created on the ground and surveyed using DGNS, and two sets of photos were then acquired for two distinct Hi-Res photogrammetric surveys of the two best-preserved piers (Pl. VIII.2);
- during the second half-day (10th July 2022), a UAV was flown – thanks to a special permission granted by the Mosul Operations – over the area for general mapping, and 13 gcp created on the ground (some of them also employed during the previous survey) were used for better georeferencing the results.

The survey of Pier 1 (Pl. VII) required the acquisition, through an SLR camera used directly by the operator at ground level, of 222 images over a total time of 10 minutes, while Pier 3 (Pl. VIII), preserved to a height of more than 2.5 m, required the use of a telescopic pole for the first 92 photos out of the 392 in total, acquired in 17 minutes. The three different datasets were then processed using Agisoft Metashape (version 1.8.2 build 14127) first into 3D point clouds, then into texturised 3D meshes: the digital products obtained (georeferenced Orthomosaics and DEMs) were finally exported as GeoTif into QGIS in order to produce the topographic documentation presented in this paper.

A Mavic Mini drone connected to the Dronelink app was used for the general mapping of the area, which allowed us to set up a programmed flight otherwise not possible with DJI's native app. An area of about 0.2 hectares was mapped at a constant height of 5 m above the ground. The 662 photos obtained in the approximately 23 minutes of total flight time (for a total distance covered by the drone of 900 linear meters) were processed, as for the July 7th survey, with Agisoft Metashape software, obtaining 3D point clouds, texturised 3D meshes (Pl. II.1), georeferenced Orthomosaic and DEM (Pl. I.2).

The different scale of the “single pier survey” versus the “entire area survey” ensures the best level of accuracy in the selected areas of the two better preserved piers, while the rest of the site had a coverage that allowed a good accuracy but at the same time required reasonable post-processing times: just as a raw comparison it should be noted that the total number of photos acquired for the survey of the two piers is almost equivalent to the number of photos required for the general survey of the area.

While the “single pier survey” allowed us to document the state of preservation and use of the individual blocks used for construction and thus further investigate the construction technique (*v. infra*), the “entire area survey” allowed us to reconstruct the course of the bridge and the distance of the piers (at least for the portion between the preserved piers).

In order to calculate the dimensions of the span and thus the distance between the piers, we proceeded from the two of the four present, which retain the entire base perimeter. Since the distance between these two piers is 37 m, and the overall size of the pier itself is 2.7 m, we assumed the presence of three piers (one partially preserved, the other two with traces of quarrying), then subtracted the overall size of the three piers ($2.7 \times 3 \text{ m} = 8.1 \text{ m}$) from 37 m, obtaining 28.9 m and dividing it by 4 (the distance between two piers). The

resulting distance between two piers is 7.22 m. Therefore, having the width of the pier (2.7 m) and the distance between two adjacent piers (7.22 m), we then reconstructed the layout of the bridge and the piers until we reached the north-eastern pier of the four. The reconstruction coincided exactly with the edge of this pier, of which only a few blocks of the southern profile were preserved, allowing us to validate our interpretation.

The DEM, processed in QGIS using slope analysis, confirmed the presence of the missing piers, whose blocks were probably quarried to be reused, showing anomalous depressions in the positions predicted by our hypothetical reconstruction. In the DEM view it can be seen that in the proximity of the two hypothesised piers (among the better-preserved ones), a hollow area is visible, and thanks to the images obtained with the slope function in QGIS, the evidence is confirmed by the more pronounced slope lines in the proximity of the two hypothesised piers.

As for the bridge over the Khosr, its piers (Pls. XXVII-XXIX and marked in blue in Fig. 1) have not been surveyed by us but they are visible on satellite imagery: both from the latter and from historical and contemporary photographs they seem to have been built at the same distance apart as those of the Tigris bridge.

2.3. Notes on construction methods (CP)

The two best-preserved piers (1 and 3 in Pl. XXXV) show two different states of conservation: the plan is the same, with a rectangle measuring 9.5x2.5 m in which one of the two short sides is formed by an arc of a circle and the other by two semi-arcs that meet to form an acute angle, in a boat-like shape. The southernmost pier (1) retains only the first course of rusticated ashlar (a few are missing on both short sides) enclosing a rubble stone fill consisting of variously sized rocks, ranging from multi-decimetric to multi-centimetric. The rubble stone fill is also clearly visible in the pier immediately to the north (2), which is now completely lacking the frame ashlar. In both piers, the rubble stone fill is embedded in a brown soil with a compact matrix.

As far as can be seen from Pier 2, the basal course of ashlar did not rest on any specific surface preparation: what seems more likely is that the ground was levelled with a small quantity of soil and small stones. The ashlar of the first course frequently have holes through which metal elements can be seen: these are iron rods with a diameter betwe-



Fig. 1 - Location of the Old Bridge within modern Mosul and its extant piers (basemap from openstreetmap and building footprints from <https://data.nextgis.com>).



Fig. 2 - Plan and elevation of the south-western long side of Pier 3.

en 1 and 1.5 cm, which probably were used to anchor the blocks of the first course to the ground (Pl. III). In Pier 3, which is preserved on the short north-west side to a height of between two and three courses and on the remaining three sides to a height of six courses (Fig. 2), the holes with corresponding iron rods are still present but rarer, while one or two parallel grooves can be observed in each block in which iron clamps are fitted, holding all the perimeter ashlar interlocked (Pl. IV.1).

Since such grooves are completely absent in the ashlar of Pier 1, this suggests that the anchorage to the ground of the base course was ensured by the vertical rods (Fig. 3 above left), while from the second course upwards the solidity of the structure was assisted by the clamps (Fig. 3 below right): it must be considered that the first method involves drilling a hole through the ashlar, while for the installation of the clamps, in addition to the excavation of the groove, a hole of about ten cm was probably enough. Such grooves are completely absent in the ashlar of pier 1. This suggests that the purpose of the vertical rods was to anchor the base course securely to the ground while the horizontal clamps were intended to hold the structure together from the second course upwards (Fig. 3 above right). An additional function as plugs could have been performed by the first course vertical rods if protruding from the top face of the ashlar (Fig. 3 below left, Pls. IV.2 and V).

At the foot of the mound where a river police station currently stands, the half-buried remains of a further pier (Pier 4) have been identified, showing the same construction elements with the presence of rusticated ashlar, and the use of clamps and pegs to guarantee greater stability to the structure (Pl. VI). The ashlar employed for the piers are made of a yellowish-brown limestone and can be distinguished into two types: rusticated and smooth undecorated ashlar. Apart from one block in pile 1, rusticated ashlar are only present on the two straight sides, while the curved sides are made up of smoothed stones. The external face of rusticated ashlar presents a band along the perimeter where the surface has been removed and finely smoothed by a couple of centimeters to emphasise the rough texture of the limestone. The width of the band can vary between 2 and 10 cm and chisel marks can be clearly seen. Similar rusticated ashlar have been recently mapped in area G in Nineveh. Area G includes a 10 m tract of the 12 km-long defensive city wall that Sennacherib had built around 704 BC to protect the now greatly enlarged new capi-

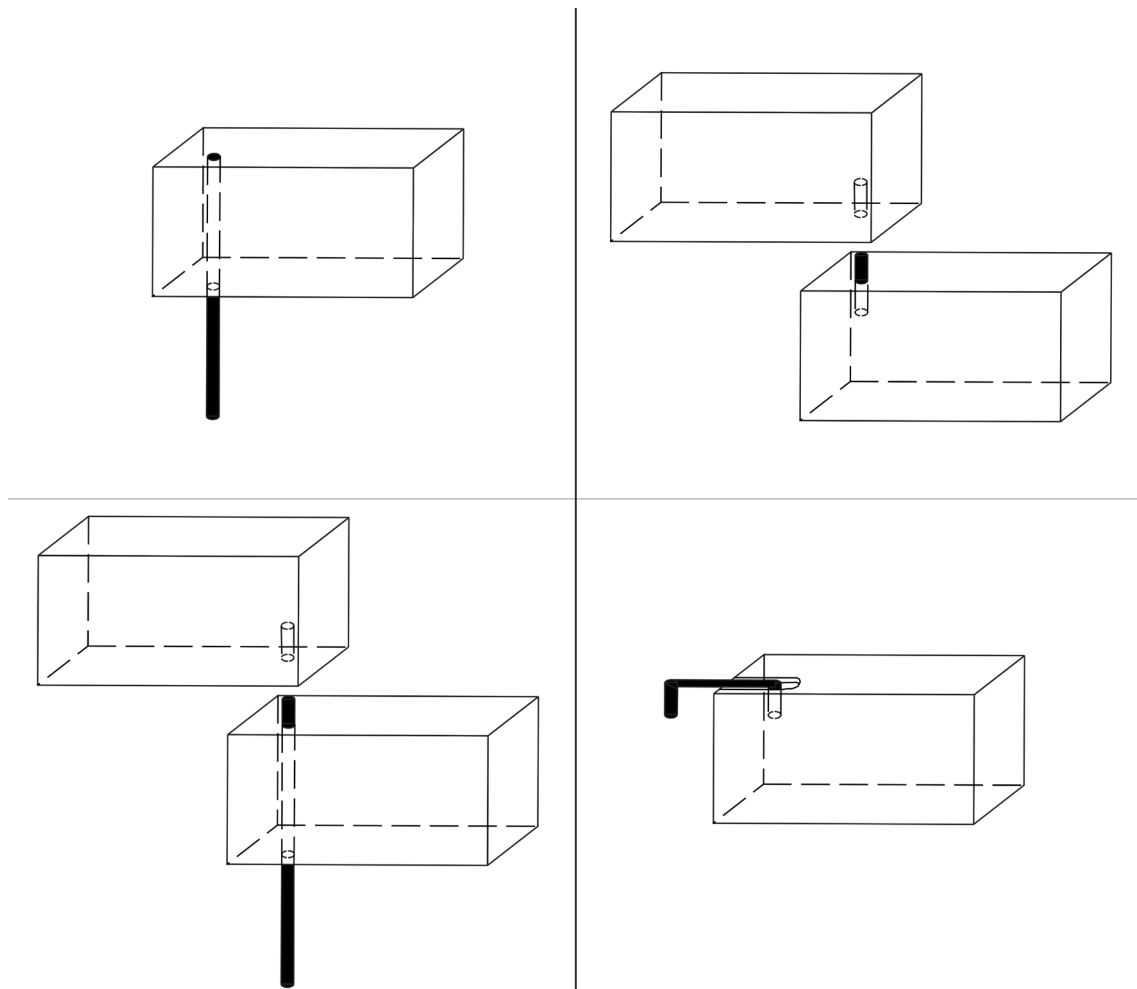

Fig. 3 - Documented iron elements and their possible function. Above left: iron rods running completely through the block anchoring the first course ashlar to the ground; above right: iron plugs connecting ashlar from the second course upwards; below left: iron rods running completely through the block and protruding from the top face; below right: iron clamps interlocking the ashlar from the second course upwards.

tal. Peculiar to this area is the presence of a 42m-long Water Tunnel built of stone blocks within the thickness of the city walls themselves.

In terms of construction technique, the wall ashlar in area G also show clear signs of chiseling in the smoothed outer band. The only apparent difference between our ashlar and those in zone G concerns height: our blocks are all approximately 38 or 57 cm high, while the others show considerable variability with blocks characterised by different heights even within the same course. Both in our piers and in area G wall the width of

the ashlar is extremely variable ranging from 17 cm to 1 m. As Reade reminds us (v. infra 2.4 Ottoman bridges at Mosul) Smith mentions the use of blocks from the “facing wall of Kouyunjik, and the basement wall of the palace of Assurbanipal” (1875: 90, 96) to build an Ottoman bridge across the Tigris: we can thus reasonably hypothesise that the rusticated ashlar is Assyrian while the undecorated ones (used mainly for the curved sides) were recut. The only rusticated ashlar used in the curved sides is a stone of less than 50 cm in the south-east corner of Pier 1 and, although its outer face is straight, it has been cut with a trapezoidal plan to create a curved face together with larger, curved ashlar.

In analyzing construction techniques, a final aspect to be mentioned concerns the height of the courses: as already said, the only pier that conserves more than one course is Pier 3 and we can only base our considerations on it. Pier 3 shows now at its maximum height 6 courses of ashlar: from bottom to top the first (just like the only one visible in Pier 1), third, fifth and sixth courses consist of 38 cm high blocks, while the second and the fourth courses consist of 57 cm high stones. It should be noted that 57 cm is very close to the range between 53 and 55 cm that Powell (1987-1990: 474) assigns to the cubit in the Neo-Assyrian period. If we consider 57 cm to be the length of the ‘royal’ cubit under the king of the builders of those ashlar (Assurbanipal according to Smith 1875), then the measurement of 38 cm could be interpreted as a submultiple (corresponding to $2/3$) of the same unit of measurement.

3. BACKGROUND AND HISTORY OF THE OLD BRIDGE (*JER*)

3.1. *Background and documentation*

The old city of Mosul in the Ottoman period, unlike the modern city which has spread since the 1950s across land on both sides of the Tigris river, was entirely located on the right or south-west bank, directly opposite ancient Nineveh on the north-east. Mosul was an administrative seat of government. It was a centre through which long-distance commercial land and river traffic between what are now Iraq, northern Syria and southern Turkey could conveniently pass. Most of its rich agricultural hinterland lay east of the

city. It was desirable for many reasons that there should be adequate means of crossing the river at Mosul.

The late Sa'id al-Daywachi, Director of the Mosul Museum, whose help in obtaining photographs of a manuscript in one of the mosque libraries I recall with gratitude, devoted a careful study to the bridges of the city (Pl. IX.1). He combined Arabic and European documentation with local knowledge (Daywachi 1956). The present study deals principally with methods of crossing the river that were recorded between the eighteenth and mid-twentieth centuries. It owes much to Daywachi but utilises additional sources to which I happen to have convenient access, including many illustrations, some of poor quality but the best available. I am grateful to Auday Hussein for a scan of Daywachi's paper, to Noorah al-Gailani for advice on two Arabic names, and to her, Daniele Morandi Bonacossi, Nicolò Marchetti, Kiersten Neumann and St John Simpson for further illustrations that have resolved questions present in a first draft of this study.

Several western travellers, complete with their prejudices, have been quoted at length; they provide valuable observations. Shields (2000) gives a vivid account of the Ottoman city and its economy. There are undoubtedly further sources of information in Iraqi, Ottoman and European archives, such as those listed by Longrigg (1925: 331-340), which could correct some of what I have written and add context to what has turned out to be a surprisingly complicated story.

3.2. *The Tigris at Mosul*

The behaviour and course of the Tigris at Mosul must have changed since prehistoric times as its catchment area was scoured by deforestation, but no detailed records are available. In recent times, before the construction of dams upstream, the width and depth of the river varied through the year, rising somewhat in winter and increasing dramatically in spring as snow melted in the mountains of eastern Anatolia.

A helpful plan is that prepared by Felix Jones in March-April 1852 (Pl. IX.2). The relevant Handbook (Intelligence Division 1917: 362) gives the width of the whole river-bed, covered in high flood, as about 675 yds (617 m), with a deep channel on the west of about 150-200 yds (137-183 m). The information in these Handbook volumes is undated and was gathered from various sources but was intended for potential use by

the British armed forces and seems generally sound. Exceptionally, after a period of severe drought about 1871, Paterson (1895: 112) refers to the bed of the river as “nothing but a long chain of water-pools”. In contrast, about 1906 “the Tigris was nearly frozen over, and for three days the only water we could obtain was from melted snow... This was a record winter, there having been no such frost for one hundred and fifty years” (Hume-Griffith 1909: 180).

The old city wall of Mosul once rose steeply from the western bank, and the Handbook adds that on this side the river “cuts into the side of its trough and threatens some of the buildings of the town”. Many were badly flooded in 1831 according to Wallis Budge (1920: II, 40-41), but that was in the lower southern part of town. A photograph from 1965, in contrast, shows the remains of a tower of the city wall further north (Pl. X.1), incorporating at least three phases of construction.

The phases are consistent with the al-Mawşil entry in the Encyclopaedia of Islam (Honigmann and Bosworth 1991). At the bottom is solid ashlar masonry, with a rounded ground-plan, incorporating also one or two reused pieces with a moulded surface; they look as if they could have been Assyrian blocks. This could be part of the Sasanian fortress of Budh-Ardashir or Bih-Hormiz-Kawadh, which was reused or rebuilt in the Umayyad period. It supports a tower of rubble masonry, either rounded or polygonal in plan; this must be medieval Islamic. On top there is a structure including irregular flat stones and probably once supporting a mudbrick superstructure, which should represent the final recorded repair of the city wall by Husein al-Jalili about AD 1743. The Imam Yahya shrine built by Badr-al-Din Lulu in AD 1239 is visible beyond the tower while in the distance is the detached tower of Bash Tabia, slightly earlier. Two large blocks resembling fallen masonry are among material collapsing from the cliff. A ninth-century Assyrian winged bull was observed on its side near here in the 1930s but how it arrived, fallen from an ancient building or sunk in transit across the Tigris, is unclear (Reade 2018: 170, Fig. 2). Photographs taken by Marchetti in 2022 indicate extensive alterations to the tower since 1965, with the stonework at the base reinforced and the rubble wall consolidated but the uppermost wall removed. There has also been destruction due to the Daesh occupation and fighting during 2014-2017. These remains suggest that the river advances very slowly in this area and that there has not been any substantial change for many centuries.

The north-east edge of the flood plain opposite Mosul is less easily defined. In the dry season the Tigris was generally divided by a low island into two channels, a wide deep channel on the west and a narrow shallower eastern one. The island was soon submerged when the water-level rose in spring, and the river in full flood could be much wider than the 617 m given in the Handbook. The rising flood spread eastward across land, on the left bank, which also constitutes the delta of another smaller river, the Khosr. This latter comes from the north-east and is almost dry for much of the year but full after heavy rain; it was partly diverted to irrigate fields in the flood plain and has had several channels. If the Tigris reached the ancient wall of Nineveh, absorbing the lower Khosr, it was some 1750 m wide. At its maximum the flood entirely surrounded the mounds of Kuyunjik and Nabi Yunus inside the ancient wall. The river must then have been 2500 m wide. This happened in 1831 and 1889 according to Budge (1920: II, 40-41, 81).

3.3. Crossing the Tigris before the Ottoman period

The main crossing points at Nineveh in the Assyrian period would have depended in part on the locations and depths of the Tigris and Khosr, which may have varied. The harbour or market (*karum*) area of the ancient city lay between modern Kuyunjik and Nabi Yunus; this is opposite the southern side of old Mosul, possibly ancient Adia. Goods from the west and from upstream could have entered Nineveh here, through Gate 15 (Reade 2016: 59). A crossing point could then have remained in virtually the same position through all later periods, as the Ottoman route led from the southern side of old Mosul across the river and passed between Kuyunjik and Nabi Yunus on its way east towards the next major centre at Erbil. In the Assyrian period there was also Nineveh Gate 18, which was located further south on one or the other side of Nabi Yunus and which was used by caravans bringing goods from Yemen; presumably this gate was approached from a crossing point south of the old city of Mosul, where Rich described the water as much shallower.

There are references to boats crossing the river at or near Nineveh in the Assyrian period (e.g. Parpola 1987: 52; Grayson and Novotny 2012: 119). Carved illustrations of the river c. 650 BC, now lost but surviving in drawings (Pl. X.2), show inflated skins being used as floats by individual men and as supports for a large raft, like the kelek rafts familiar from accounts of the Ottoman period (see Appendix 4), while boats with a helmsman

at the stern and seated oarsmen in front are precursors of the Ottoman ferries. Boats or rafts must always have been used for groups crossing during high water and for the transport of very heavy loads.

No mention of a regular ford has been found, either in ancient or in modern sources. Yet that is not a decisive argument for or against one, since the early documentation tends to refer to unusual circumstances rather than to standard practice. Claudius Rich (1836: II, 47) recorded that in November 1820 the depth of the river ranged from 50 feet (15 m) near the middle of the old city to a mere 5 feet (1.5 m) some two miles (3200 m) downstream.

There is no evidence for a permanent structure crossing the main channel of the Tigris at Nineveh in the Assyrian period, nor for a pontoon bridge (this is often described in English accounts as a bridge of boats). A pontoon bridge over a canal off the Euphrates near Borsippa in Babylonia features in an Assyrian letter discussed by Simo Parpola (1983: 295; 1993: 300-301). That water will have been placid. It would have been far more difficult to maintain a pontoon bridge across the middle Tigris, but the technology existed in principle. Not long afterwards, in the late sixth century, Mandrokles of Samos designed a bridge of boats that enabled the Persian king Darius to transport an army overseas, from Asia to Europe, across the difficult currents of the Bosphorus (Herodotus IV, 87-88). In later Greco-Roman literature there are many references to pontoon bridges, including bridges across the Greater and Lesser Zab rivers in the fourth century AD (Ammianus Marcellinus 23.vi.21). The situation at Nineveh does not seem to be mentioned, probably because the Persian Royal Road and its successors crossed the Tigris upstream nearer Cizre (Jazira bin Umar) rather than at Nineveh.

A pontoon bridge does seem to have existed at Mosul through all or nearly all the Islamic period (Daywachi 1956: 111-115). One of the city-gates was known as Bab al-Jisr (Bridge Gate), near the Suq al-Jisr (Bridge Market), from which streets radiated throughout the city. The first identified reference to bridge construction is in the reign of the last Umayyad caliph, Marwan II (AD 744-750). The built sections of the bridge must have consisted primarily of structures to which the ends of the line of pontoons could be secured. The structure on the eastern side, exposed to fast-flowing water and submerged almost every year, will have been vulnerable to damage. There are several references to

bridge building or rebuilding over the following centuries, and to the bridge (i.e. the line of pontoons) being cut to prevent military attack. One ruler recorded as restoring the bridge was Timur (Tamerlane) in the late fifteenth century; this work would have facilitated access from Mosul to the shrine of Nabi Yunus which he also restored.

Daywachi (1956: 119-121) discusses in addition the al-Mujahidi Bridge, built by Mujahid-al-Din Qaimaz (died AD 1198) and destroyed by the Mongols in AD 1261. It is said to have been a permanent bridge across the Tigris, located in the extensive suburb that developed in this period to the south of the city outside the walls.

3.4. *Ottoman bridges at Mosul*

Mosul was under Ottoman control first in 1517 and then, after a long struggle with Persia, continuously during 1639-1918. The existence of a pontoon bridge across the main channel of the river is mentioned by Leonhard Rauwolff, who crossed it in January 1575 (Ray 1693: I, 204), and by Jean-Baptiste Tavernier, who was there in February 1652 (Tavernier 1678: 226-230). A fuller account is provided by Jean de Thévenot who saw it in July 1664. The bridge “consists of about thirty boats, on which they pass to an isle. The other end reaches not the land, unless it be by a stone causeway, which is as long as the bridge itself where it ends. In winter that bridge is removed, because the river (then overflowing) becomes as broad again as it is in summer” (translation adjusted from Thévenot 1687: 50).

De Thévenot’s causeway has to be an earlier version of the earliest structure on the east side of the river known to Daywachi (1956: 115-119). The latter consisted of a row of stone arches forming a bridge which crossed the narrow eastern branch of the Tigris and thereby improved access to the pontoon bridge from that direction. It must have been in much the same place as later versions. The arches lie at a slight angle to the main course of the river; this gives the impression that the plan is a skeuomorph, with the row of stone piers reflecting a previous row of pontoons pushed downstream by the current, but the plan will have been controlled by topography. Daywachi records that the work was commissioned in 1720 by Sari Mustafa Pasha (whose unusual name signifies “Mast of the Prophet”, pers. comm. Noorah al-Gailani). The arches were liable to be damaged by the spring floods. There was renovation work by al-Hajj Husein Pasha bin Ismail Pasha

al-Jalili in 1741, by Namiq Pasha Governor of Baghdad in 1766, and by Bakr Effendi bin Yunus Effendi in 1786.

The design, even if it was always needing repair, represented a sensible attempt to bridge part of the Tigris. Gertrude Bell (1911: 237) observed the remains of what she thought to be a bridge built on the same principle at Samarra, between the capital city on the east bank and Qasr al-Ashiq on the west. That would probably date to the late ninth century. The arches of a bridge like this are surrounded by water in the flood season but stand for most of the year high and dry, looking as if the structure is itself either the remains of a bridge that did once cross a river or an unfinished attempt at a bridge intended to cross. This illusion led to derogatory comments from travellers who did not understand the system at Mosul or recorded it wrongly. Given Bell's observation at Samarra, it seems entirely possible that the design of the Mosul bridge was much older than the Ottoman period, going back to Marwan II or to one of the other rulers responsible for the fine architecture of medieval Mosul.

European travellers in the eighteenth century were unimpressed. Jean Otter crossed by ferry in April 1738; he does not mention a stone bridge at all (Otter 1748: I, 146). Edward Ives, coming from the east in July 1758, "crossed part of the Tigris on horse-back, and the other part by a bridge of 19 boats: a little higher up the river, are the decayed arches of an ancient stone bridge. The water of the Tigris is very low here, and far from being rapid" (Ives 1773: 320). In current academic usage the word "ancient" tends to denote "pre-medieval", but that need not be what Ives meant.

Carsten Niebuhr (1774-8: II, 353-354) was there in March 1766 and provides a typically informative account, given here in translation. "There is a bridge from Nineveh to Mosul like those at Baghdad and Hillah, but the river here is only 66 double paces (about 300 feet) wide and there are only 20 boats under the bridge. After heavy rain or when the snow in the surrounding mountains melts, the river rises so high that the bridge must be let loose against one bank, so as not to be broken by the current. This happened on 23 March, for the second if not third time this year. The water only rose a few feet, and on 1 April the bridge of boats was again fastened across the river. The bank on the east side is neither high nor solid, and so the road to the bridge is often very bad. Some years ago, the Pasha built a dam or rather bridge up to the bridge of boats, but the arches were so low

and narrow that they were broken by the first high water, and now the road is even worse than before”. Niebuhr also published a plan of Mosul including the bridge with only six pontoons, plainly schematic (Pl. XI.1); the east bank is represented in an impressionistic manner, with no trace of a stone bridge, clearly because he had not been free to survey the area in detail.

In 1798 the same Bakr Effendi who had commissioned the 1786 work initiated a serious attempt to create a more resilient structure (Daywachi 1956: 118). Over a period of seven months, he built six arches; after the flood in the following year, 1799, he built a further ten arches, bringing the total to sixteen. He used solid rocks (*sukhur*), a material perhaps superior to whatever was used previously. They must have been Assyrian blocks that he extracted from the ruins of Nineveh, as recorded by Rich (1836: II, 126); a photograph published in 1920 shows this kind of extraction in progress (Pl. XI.2).

The sixteen-arch bridge was surely identical with one described and mapped in 1820 by Rich and his Greek companion, Captain Kefala (Rich 1836: II, 47, plan facing p. 29; Pl. XII.1). “The bridge of boats at the city is three hundred and five feet [93 m] in length, and consists of twenty-one boats; then comes a space of one hundred and forty feet [43 m] to the end of a stone bridge of sixteen arches [of] five hundred and twelve feet [156 m], in all nine hundred and fifty-seven feet [292 m] for the whole of which space is occupied by the river in the spring and early summer. I have seen it in this state twice on two former visits to this place; at present a small stream of one foot [30 cm] deep only passes through it; the bridge forms an obtuse angle at its centre. The bridge of boats is extended to the stone, when the river rises and covers the pebbly bed, which is now a vacant space of one hundred and forty feet [156 m] between the two bridges”. The obtuse angle of the bridge, also visible in the plan, may reflect the two separate phases of construction in 1798 and 1799. When the bridge of boats was fully extended to the east it presumably comprised about thirty boats, the number given by de Thévenot.

Slightly further east there was also a branch of the Khosr; this was flowing from north to south across the main track. “There is a small bridge of three arches over this channel, very near the bridge of Mousul; but when it [the Khosr] is much overflowed, it discharges itself into the Tigris above the bridge” (Rich 1836: II, 56). The point where the track crosses the Khosr is blurred on Rich’s plan, but a bridge is present in roughly the same

position on Jones' plan, prepared in 1852 (Pl. IX.2). This lower bridge across the Khosr has to be distinguished from another upper bridge which was built in 1912 across the Khosr near the south-west corner of Kuyunjik. The later history of the two Khosr bridges is discussed below in Appendices 2-3.

There is a minor problem with the original lower bridge across the Khosr. Rich assigns it three arches. J. S. Buckingham, who was there in July 1816, describes how “descending through the town to the river, we crossed [the Tigris], over a bridge of boats, which was just one hundred and fifty horse-paces in length. The boats were badly constructed, and not being fastened together in the most secure manner, the whole bridge was set in motion by the least agitation of the water. They were moored head and stern by iron chains, and were sharp at each end... We went from hence towards the north-east, and passing over a stone bridge of Mohammedan work, thrown across a small stream, which discharges itself into the Tigris, came in about an hour to the principal mounds which are thought to mark the site of the ancient Nineveh” (Buckingham 1827: 298-299). On his return from Nabi Yunus “we passed again by the stone bridge, over a rivulet coming from the eastward, till it empties itself, close by this, into the river, and remarked, that it has fifteen pointed arches, but of very inferior masonry” (Buckingham 1827: 308).

A single bridge can hardly have three arches (as stated by Rich) and fifteen (as stated by Buckingham). A possible explanation is that Buckingham, in preparing his diary notes for publication, conflated two bridges. If so, he did indeed pass “over” the three-arched lower bridge across the Khosr on his outward journey to Kuyunjik but did not observe or count the arches. Then, on his return, coming from Nabi Yunus, he naturally took a track slightly further south and passed “by” a bridge which he did not cross; he saw it from the side, however, and counted fifteen arches. He deduced that the two bridges were the same, but really the one he saw on his return journey was Bakr Effendi's Tigris bridge, with one of its sixteen arches fallen and no longer visible.

Moreover, in March 1817, less than a year after Buckingham's visit, William Heude found the Tigris bridge in ruin. He writes that, from the east, Mosul “is approached by a stone bridge of fifteen arches, but of which five in the centre have fallen in, so that a ferry must be employed in crossing the stream” (Heude 1819: 217). So, he too saw fifteen rather than sixteen arches. There is another problem here, however, because Rich's account

of the Tigris bridge, dated 12 November 1820, plainly implies that it is in good repair, with sixteen arches. If Rich's description refers to the state of the bridge in 1820, it must have been repaired since Heude's visit in 1817. An alternative is that there is an error in Rich's book, which was edited by his widow many years later, and that it describes the state of the bridge as he had seen it during one of his earlier visits rather than its actual state in 1820.

Heude implies that he thought the stone bridge had once reached across the entire river. This is probably because he was hurrying (he only stayed one night in Mosul), was crossing by ferry, and may not have noticed the pontoon bridge which must have been moored against the west bank because of the flood. He was not the only person to make this mistake, e.g. "Formerly a stone bridge existed, but, after it had been destroyed, no attempt was made to rebuild it; the Turks, however thoroughly they may understand the science of destruction, not, at least of late years, appearing to comprehend that of restoration" (Ussher 1865: 398). Despite Ussher's criticism, it did become the case that "repairs to the bridges over Mosul's unpredictable rivers was a frequent government expense" (Shields 2000: 107). On the other hand, the Tigris bridge described by Rich was certainly in a state of ruin after 1820. Mitford (1884: 283), who was there in 1840, refers to boats crossing the river but does not mention a stone bridge.

One image, published by the Rev. George Percy Badger who visited Mosul more than once during 1843-1850, does show a remnant of it (Pl. XII.2). The drawing is a view of the city from the eastern bank, with the pontoon bridge in use and the towers of Bab al-Jisr in the distance. There are more than twenty-one pontoons, so that this is a time when the island dividing the Tigris into two channels was submerged and the pontoon bridge was therefore extended eastward across it. People are moving up a ramp from the bank to the roadway along the top of the pontoon bridge. An adjoining structure of two pointed arches, which is broken on the east, may be identified as the remains of Bakr Effendi's stone bridge that once crossed the narrow eastern channel.

The situation in 1852 is also described by Jones (1855: 305). "A bridge of boats at present spans [the Tigris] at Mosul, where a solid structure previously stood at no very distant period. From appearances above water, it certainly looks like a modern work, and, we believe, has received repairs, even in the last century". This has to be the structure

seen by Rich and Badger. Jones' plan (Pl. IX.2) duly includes ten "piers of an ancient bridge", with another three piers at an obtuse angle at the western end. The pontoon bridge passes slightly downstream; there are only twelve pontoons in Jones' plan but that has to be schematic.

There are many references to the pontoon bridge by European travellers visiting Mosul between the 1830s and 1870s. Asahel Grant, who was there in the dry season in September 1839, gives a vivid description. "The bridge of boats was thronged with a motley crowd of Koords, Arabs, Turks, Christians, and Jews, clad in their various and grotesque costumes; and, in their confused jargon of dissonant voices, bearing unequivocal testimony to the curse of Babel. Their camels, mules, horses, bullocks, and donkeys were laden with the various produce of the country, with which the markets are crowded in an early hour of the morning, especially at this season of the year, when grain, fruits, melons, and vegetables are abundant. Some of the loads had fallen upon the bridge, increasing the confusion, which already threatened to precipitate man and beast into the deep and rapid current of the Tigris, which was then about 150 yards [137 m] wide at that place, though much broader at high water" (Grant 1841: 28-29). M. E. Hume-Griffith (1909: 206), who worked in Mosul during about 1905-1908, notes that the bridge was also much used to catch fish, either by a baited line or by throwing an unspecified poison into the water. The latter system was most effective, and fish floated to the surface; I was told of explosives being used for the same purpose on the Tigris below Mosul in the 1950s.

Shields (2000: 110-114), in a general account of rapidly changing economic circumstances in the late Ottoman period, mentions that tolls were sometimes charged on animals and pedestrians crossing the bridge, and that "the right to collect customs duties for the city of Mosul was purchased at an auction". So, there was always a financial incentive to keep people moving across the pontoon bridge, but business continued even without any maintenance of the stone arches.

Frederick Walpole, who was at Mosul in late June 1850, gives a more technical description of the pontoon arrangement. The boats "are moored head and stern abreast, nearly close together, with a platform on each; two or three boats are connected by one part of this. This, during my stay, was out of repair, so the passage was effected by boats, numbers of which plied across. The bridge of boats is secured on the townward side

to a water-port, on the other it met a low stone pier that stretched across the shallower portion of the river. Thus, here it was confined within narrower limits than usual, leaving but a small space for the boats to span. During the period of the freshets in the river these are always removed, and few years pass that the river does not overflow the wharf on the eastern side, flooding the flat land within it” (Walpole 1851: II, 4). A “low pier” or “wharf” does not sound like the ruin of an arched bridge. Perhaps Walpole is describing the structure to which the eastern end of the pontoon bridge was secured. The western end of the pontoon bridge in position in 1880, with the building to which it was then fastened, appears on the left side of a drawing by Tristram Ellis (Pl. XIII.1).

The pontoon bridge continued to attract mixed disapproval and puzzlement from Europeans, e.g. “a crazy but picturesque bridge of boats” (McCoan 1879: II, 100). Budge described what he saw in 1889. “These [boats] are pointed at each end, and are moored by iron chains upstream and downstream. Above the boats there is a layer of earth which rests on a layer of branches of trees, and these in turn rest upon a layer of poles, which are sometimes split and sometimes not; these layers form the roadway of the bridge. The boats were old and rickety, and I was not surprised to hear that when the great rise of the river took place about a month later, most of them were smashed” (Budge 1920: II, 45-46). It seems likely that, as is done with roofs, a layer of matting was also laid between the poles and the earth.

Men could also cross the river by swimming, as they had done since time immemorial (Pl. X.2), and horses too could swim. Inflated skins assisted with the transport of goods. The merits of alternative techniques visible in Assyrian images are discussed by De Graeve (1981: 80-82). Victor Place (1870: II, 137) remarks that it was normal for Arabs travelling alone in spring to carry a skin, ready for use in case one of the streams was swollen. An Arab technique witnessed near Mosul, which required two skins rather than one, is described by David Fraser (1909: 228-229). “Desirous of reaching the opposite bank, he walks up-stream to a point from which he calculates to make his destination, and there prepares. He begins by blowing up two skins and tying them together. Next, he strips naked and packs his clothes either on the top of his head or upon the diminutive raft. All is now ready, and our friend, rifle in hand, wades into the water, pushing the skins before him. When up to his middle he halts and proceeds to mount. With the

tenderest care he lays his stomach across the nearest mussock and spreads his elbows over the one beyond, both hands tightly grasping the rifle. He carefully feels the position by lifting his feet off the ground, makes any adjustment necessary, and then turns on the steam, which consists of furiously paddling with the legs". A similar technique is also described by Ellis (1881: I, 87).

Layard (1903: II, 168) described the ferry-boats that were used when the pontoon bridge was cut. "The boats in use upon the Tigris are of the rudest construction. They have a pointed prow rising high out of the water, and a lofty poop upon which stands the man who steers, with a rudder in the shape of a long and heavy oar. By his side there is only sufficient space for one more person. In the body of the boat, which was deep, spacious, and usually very dirty, stood the passengers—frequently crowded together with horses, donkeys and other beasts. The oarsmen sat on high benches".

Walpole was more complimentary. "The boats used for the passage are large and well built, remarkably high behind, sharp bowed, with a small sheer forward. The stern may be six feet [1.8 m] out of the water, the bow two [0.6 m]. They are nearly flat-bottomed, with a good beam in the after part, pulled by two oars, with two or three men at the lee one, where the greater strength is required. A stern oar directs their motions... These boats are required to be constantly hauled up, when their bottoms are covered with pitch; every night also at sunset they are compelled to cease to ply" (Walpole 1851: II, 4-5).

When Henry Ross in 1842 described the vessel as a "clumsy and queerly constructed ferry-boat, large enough to carry several horses" (Ross 1902: 22), he is citing what really mattered, function rather than appearance. Similarly, Mark Sykes' condemnation of the much cruder design of ferries at Shergat, downstream from Mosul, is tempered by the fact that he and his party including animals all crossed safely together (Sykes 1904: 183-184). The critical factor for boatmen on the middle Tigris is that wells such as those at Qaiyara and Nimrud provided limitless supplies of pitch or bitumen that were then available for caulking boats.

A problem for ferry-boats was the speed of the river. Ellis (1881: I, 110-111), who crossed from the east bank in 1880, says that the "ferry boats of antique construction ... got taken down a mile by the current each time they crossed... Eight men, two to each of the long oars, began rowing as if their life depended on it, screaming and dancing about

meanwhile like a set of lunatics”. According to Budge (1920: II, 81), “the current carried their boats a long way down the river, and it was very difficult to find any landing-place. Sometimes the clumsy boats were drawn into backwaters, where they grounded, and men and women and sheep had to get out into the water and wade to land”. An engraving shows the landing place with ferry-boats safely docked on the western side (Pl. XIII.2).

George Smith arrived in Mosul in 1872. Referring back to the period of the British excavations that ended in 1855, he states “The Turks have since built a bridge part of the way across the Tigris, and for this purpose they pulled down and carried away the exposed facing wall of Kouyunjik, and the basement wall of the palace of Assurbanipal ... this pit had been used since the close of the last excavations for a quarry, and stones for the building of the Mosul bridge had been regularly extracted from it” (Smith 1875: 90, 96). Auday Hussein (pers. comm.) has noted that Assyrian column-bases were used in the Al-Pasha mosque in Mosul during 1867. So a new bridge, which became the Old Bridge, was probably constructed at some time during the 1860s. It certainly existed by 1871; Daywachi (1956: 118-119) knew this because that was the year when the Shammar sheikh, Abd-al-Karim bin Sofuk, was executed by the Ottoman government, and the iron pole or gibbet from which his body hung was still visible by one of the arches until the demolition of the bridge about 1935 (see below, Appendix 1).

The bridge mentioned by Smith should be identical with the one seen by Grattan Geary in April 1878. “There is a brick bridge of many arches over three-fourths [sic] of the bed of the Tigris at Mosul. The channel near the city is some six or seven hundred feet broad [183-213 m], and is crossed by a bridge of pontoons, which can be removed when the floods come. The permanent bridge has occasioned a deposit of mud and gravel in the middle of the channel, forming an extensive island which has divided the river into two branches, and is now nearly always above the river level. Consequently, the bridge passes over dry land, water flowing past both ends of it. This seems a curious arrangement when seen for the first time. We had to ford a wide and somewhat deep channel to get to the eastern end of the bridge. We rode across the bridge—we could just as easily have ridden across the island which it traverses—and the pontoon bridge not being available on account of an expected flood, we passed over to Mosul in a barge” (Geary 1878: 47).

This is close to a description of the place two years later, in March 1880, given by Ellis

who had arrived by raft. “In front of us was a bridge of boats that barred our further progress. It led to another bridge built of stone with sixteen semicircular arches, which had a fine effect, but did not seem of much use as they were on dry ground” (Ellis 1881: I, 89). Later, however, in April 1880, “the heavy rains had swollen the river, and the bridge of boats had been removed, and even the fine sixteen-arched stone bridge on dry land could only be got at [from the east] by wading knee-deep through a branch of the river” (Ellis 1881: I, 110).

It sounds as if the deposit of mud and gravel which Geary thought to have accumulated around the bridge, forming an island, was really the island in mid-stream already described by Rich. If so, the channel which Geary and Ellis had to ford was the narrow eastern channel also described by Rich. The bridge was accessible from the ford and apparently in good condition. It is not a problem that the bridge is described by Geary as brick and by Ellis as stone, because later accounts confirm that it incorporated both materials. The number of sixteen arches counted by Ellis is the same as that of the structure seen by Rich; but those seen by Ellis did not cover the eastern channel. Another difference is that the earlier arches were pointed on top, as specified by Buckingham and shown in Pl. XII.2, but the later arches were rounded on top, as specified by Ellis and shown in Pl. XIV.1. Nearly all the large arches in Pl. XIV.1 probably date from the 1860s although the photograph itself is much later.

There is a problem, however, in Geary’s statement that the arches covered “three-fourths” of the bed. As he reckoned that the channel near the city was over 183 m wide, he was estimating the full width of the river as over 732 m and the length of the arched bridge as over 549 m. This may be compared with the length of 344 m given for the entire arched structure with ramps built in the 1890s (see below). Perhaps the “wide and somewhat deep channel” which Geary had to ford was the lower Khosr rather than the eastern channel of the Tigris, and an extension of the Old Bridge, reaching as far as the Khosr, was already built before 1878 but had disappeared by the time Ellis arrived in 1880. Much more probably Geary was misled by the way in which the pontoon bridge crossed the river at an angle, as shown in an air view probably taken in the 1920s (Pl. XIV.2), and he consequently overestimated the length of the masonry bridge, which was really the same as that seen by Ellis.

The bridge described by Ellis was seen by Budge in January-February 1889. According to him, “the eastern end of the bridge of boats is moored to the remains of the stone bridge which the Arabs (?) of the Middle Ages built over the Tigris and of which several arches capable of carrying traffic still exist” (Budge 1920: II, 46). The word “remains” implies deterioration. The question mark probably reflects Budge’s well-founded doubt whether the brickwork and semi-circular arches were really medieval.

Budge also records that the bridge had acquired another set of functions, besides its primary purpose. “Round about the arches and beyond them a sort of perpetual fair was held when the river was low, and itinerant merchants of many nationalities pitched their tents there, and did a good trade in eggs, fish, bread, rolls, melons, etc. Acrobats and mountebanks were frequently to be seen there exhibiting their skill to crowds of admiring children, and as their quips and jests were greatly appreciated by the grown-ups for their broadness and topical allusions, their patter never lacked ready listeners. When the river was very low some of the arches were used as stables by caravans which did not cross the river, and parts of others were screened off and openly used for immoral purposes, even during the day” (Budge 1920: II, 46).

Another activity when water levels allowed, beside the river bank at both ends of the bridge, was weekly laundry. “All along the shore, as far as we could see, under the walls of the town stretched a continuous line of women beating clothes with flat sticks on the stones at the water’s edge ... as we approached the bridge of boats which crossed the river lower down, we floated past a small army of [women] on the opposite shore, where a flat stretch of mud was covered with gaudy rags laid out to dry” (Jebb 1908: 195). An illustration of this process (Pl. XV.1) can be dated about 1933.

A complication with the arches of the Old Bridge is that there really were two distinct phases of construction. At some stage after Budge’s visit in 1889 his “bridge of boats ... and ... several arches capable of carrying traffic”, which had been built in the 1860s, were transformed. By 1897 the structure had become “the splendid bridge, some sixteen hundred feet [488 m] in length—half boats, half masonry—which spans the Tigris” (Percy 1898: 189). It appears in a photograph published in 1902 (Pl. XV.2). The masonry was no longer a mere bridge but a bridge incorporating a viaduct. Bell (1911: 261) called it a “causeway”. It greatly extended the row of existing arches to the east.

The date of the second phase has not been ascertained. Oswald Parry (1895: 249) was there in 1892; he only mentions the “dry arches of the stone bridge” which is ambiguous. A lady who was there on 15 March 1906 described crossing the pontoon bridge from the west “till you get to the middle of the river. There you ascend by sloping planks on to a grand stone bridge, that I think I am right in saying got this far, half-way across from the further bank, fifteen years ago. There, as is the way in Turkey-land, it stopped short, and will not be even kept in repair” (Anon. 1909: 122). This is undoubtedly Percy’s “splendid bridge”, which she supposed had been intended to span the whole river. Fifteen years before 1906 would be 1891, but she is only repeating what someone has told her.

The vertical air view (Pl. XIV.2) shows the entire length of the bridge in context, with two slight changes of direction: one change is between the two phases of construction, in the 1860s and in the 1890s, and the other is close to the river, where the ramp descends towards the level of the pontoon bridge. A photograph shows the length of the bridge viewed from the side, from the south-east (Pl. XVI.1). At the left end, on the west, the pontoons are out of sight but there is the descending ramp. This was supported by low arches although details are obscured by the base of the gibbet. The arches seem to resemble those in Pl. XVII.1, a photograph dated about 1905-8. East of the ramp in Pl. XVI.1 the bridge consists of eleven high arches on the west, on the left side of the photograph, and of eighteen slightly wider high arches on the east, on the right. At the right end, on the east, there is another ramp descending to plain level; it is supported on three lower arches. The absence, at the east end of the bridge, of the building identified as a police post by Daywachi (1956: 122), probably confirms that this photograph was taken before 1908 (see Appendix 2).

The difference in height between the two types of high arch in the bridge has to mark the junction of the two phases. The junction can also be identified with the unusually wide pier near the right edge of Pl. XIV.1. The eleven high arches on the west of Pl. XVI.1 are some of the sixteen arches seen by Ellis, built in the 1860s. The missing five were either on the left, where Pls. XIV.1 and XVI.1 show a ramp, or they were on the right, became decrepit, and were superseded in the 1890s. The eighteen high arches on the east of Pl. XVI.1 and the three arches supporting the eastern ramp constitute the major structure added during the second phase in the 1890s.

The junction can also be seen in Pls. XVII.1 and 2 but is far from clear. What these images do show is change at the western end of the structure. In both images there are two or three small narrow arches under the base of the ramp and two higher wider ones to the left. However, in Pl. XVII.1, there is one arch that is still higher and wider before the first full-size arch on the bridge proper. In Pl. XVII.2 there are instead two arches that are only slightly lower than the first full-size arch on the bridge proper, and pale patches are indicative of new masonry or plaster. In other words, the westernmost full-size arch and the top arch of the ramp in Pl. XVII.1 have been replaced in Pl. XVII.2 by two arches of intermediate size. This left only ten of the original full-size 1860s arches. The change might have been made to strengthen the structure after flood damage or to reduce the angle of the ramp. A later stage after 1918 is shown in Pls. XIV.1 and XVI.2 (below), both of which have nine arches under the ramp.

Daywachi (1956: 119) was aware that there were two distinct phases in building the main structure of the Old Bridge, but he did not think that they were widely separated in time. He dates the entire process before the erection of the gibbet in 1871. He further cites the oldest photograph he could find of the structure, which was dated to 1887. He does not reproduce that photograph, but it seems possible that it only showed some of the arches at the eastern end. Daywachi had been told that the original engineer for the structure was an Egyptian employed by the Ottoman government. He built some arches, but they were destroyed by the flood. The work was then completed by a Turkish engineer assisted by an Italian engineer named in Arabic “Bibo” (perhaps Pippo), who is said to have still had family living in Baghdad in 1956. This leaves it unclear when the Egyptian was employed, but it seems most probable that he built the first phase of rounded arches in the 1860s and that the Turk and the Italian built the second phase in the 1890s.

Because of transformations in terminology since that time, including the disappearance of Levantine and Osmanli nationalities, it is unclear what Daywachi or his sources may have meant by identifying the engineers as Egyptian, Turkish and Italian. The only definite information to hand is that in 1908 the lower Khosr bridge was rebuilt by someone with a Greek name (see below, Appendix 2). An obvious possibility is that he was from Alexandria, in which case he would surely have been regarded as Egyptian. What these terms do illustrate is how Mosul in the final decades of the Ottoman empire was no longer

dependent on local resources for public works and could call on qualified engineers from elsewhere.

The Tigris bridge built in the 1890s was seen by Fraser in 1908 and met with his approval, but the pontoons remained fatalistic. “The bridge is a wonderful affair, and yields an income of some thousands of pounds annually to the contractor who farms it from the Government. Three hundred yards [274 m] of it is solid masonry, and the remaining 150 yards [137 m] a wooden platform laid upon a row of crazy boats. Where the bridge of boats abuts the shore at one end, and the stone bridge at the other, are the points of danger, for owing to the height of the river when I was there the joinings were at a slope of forty-five degrees, and consisted of narrow gangways up which people, sheep, cattle, donkeys, mules, horses, and camels had to scramble. No wonder there were many fallings into the water—dangerous water too, for it coursed like a cataract between the boats, and swirled and boiled in fierce eddies and whirlpools below the bridge. One poor zaptieh, with rifle slung and bandoliers strapped round his chest, was walking across, when his horse slipped at the ascent to the boat part of the bridge, and both fell into the water. The horse was rescued but the man was drowned. Life has small value in Mosul, however, and nobody bothered to mend the huge holes in the bridge or to make its passage less precarious” (Fraser 1909: 215). For Victoria De Bunsen (1910: 225) it was also “a crazy bridge of boats”.

The pontoons and roadway illustrated in Pl. XVII look sturdy enough, however, unlike those criticised by Budge in 1889, and it could well be that the extension of the bridge in the 1890s had been accompanied by this neater design of pontoon, with only the upstream end pointed. What Europeans might really have appreciated is railings along the sides of the bridge. These duly appear in photographs of the bridge probably to be dated after 1918 (Pls. XVI.2 and XVIII.1).

The Handbook’s description of the state of the Mosul crossing before the Great War is as follows (Intelligence Division 1917: 362). “The bridge of boats crosses the river from a pier 32 yds [29 m] long opposite the Bab al-Jisr (in the southern half of the river-front) to a gravelly bank which is submerged when the Tigris is in flood. The boat-bridge is 125 yds [114 m] long and has a roadway of rough planking 24 ft [7.3 m] wide, which is laid on 17 pontoons, flat-bottomed boats 26 ft [7.9 m] long by 10 ft [3.0 m] wide, with a wa-

terway 10 ft [3.0 m] between each and its neighbour. The gravelly bank on the E. side of the river is crossed by a bridge of brick faced with sandstone, which is laid at an angle of about 45° to the boat-bridge. The masonry bridge is approached from the pontoon-bridge by a ramp 46 yds [42 m] long, and has a total length of 278 yds [254 m]; the roadway, which is 16 ft [4.9 m] wide, is laid on 29 arches, each of 20 ft [6.1 m] span, and at the eastern end there is a ramp 52 yds [48 m] long. Beyond the E. end of the masonry bridge the road may be under water for as much as 150 yds [137 m] in the flood season". There is an alternative description from Daywachi (1956: 119) who presumably remembered seeing the bridge when it was still in good condition in the 1930s; he states that the arches, of which he counted 33, were made of stone with fired bricks and lime above.

The use of two terms, "boat-bridge" and "pontoon-bridge", suggests that the account in the Handbook conflates two sources. The total of 29 arches in the main bridge corresponds to the number visible in Pl. XVI.1. The 33 arches later counted by Daywachi could have included some of the large arches under ramps. The Handbook description of "brick faced with sandstone" has to be wrong, but it is a common error to mistake limestone for sandstone. Daywachi also mentions the fired bricks. Unless these were modern, there was a supply of fired bricks and tiles available for collection from Assyrian buildings such as the nearby gates of Nineveh. Photographs with some detail of the structure of the bridge show that the piers and arches were faced with fine stone (Pls. XVIII.2 and XIX.1). The nature of the superstructure is unclear, but it may incorporate at least one continuous horizontal course of stonework, with bricks and possibly smaller stones above and below.

Ferry-boats of a new design for the crossing were also introduced before 1914 because, according to the Handbook (Intelligence Division 1917: 363), "These boats, of which about thirty used to be available, are each about 24 ft [7.3 m] long by 8 ft [2.2 m] wide. They are punt-shaped, with the stern cut down to allow animals to go on board. Each boat can take six laden mules".

According to Shields (2000: 107), "In 1910 the government at Istanbul allocated 1,269,343 piasters to build 1,242 meters of new bridges" at Mosul. This is roughly the distance from the lower Khosr bridge to Nabi Yunus, so perhaps there was an abortive plan to extend the bridge eastward to the wall of Nineveh.

3.5. *Overview*

It has been desirable for many reasons that there should be satisfactory means of crossing the Tigris between Mosul on the west bank and the ancient city of Nineveh on the east. Individuals could float across with small loads, horses could swim, and rafts and ferry-boats could carry a range of animals and heavy goods. Pontoon bridges, often called bridges of boats, could potentially carry traffic much more efficiently except in the time of the dangerous spring floods.

There had accordingly been a pontoon bridge across the main channel of the river since the early Islamic period, if not earlier. This was accessible directly from the city of Mosul on the west, but the approach to it from the east was hampered for much of the year by the nature of the low-lying flood plain, by the Khosr river, and by the existence of a secondary channel of the Tigris. From the seventeenth century on, there are records of a structure that facilitated access to the pontoon bridge from the east. By the end of the eighteenth century this was a bridge up to 156 m long, incorporating 16 arches, over the secondary channel.

The arches repeatedly needed repair, which was easier said than done. One problem was that, whereas Mosul had prospered in the Middle Ages, it became a remote and politically fractious corner of the Ottoman empire. Its skilled professional builders, often Jacobites like the father of the notable Moslawi archaeologist Behnam Abu Soof, were accustomed to use limestone, alabaster, rubble and gypsum, as still to be seen in many traditional buildings in the region, including mills and weirs, but their structures could not offer permanent resistance to the furious currents of the Tigris in flood. Another problem was that all work needed to be organised and financed by private or public enterprise and depended on honest officials or agents with initiative and adequate resources. Both Daywachi and Shields refer to funding procedures, and further research could probably explain developments in much greater detail.

It seems that, for these or other reasons, among them the years of famine and plague that affected Mosul during 1825-1835, there was little or no work on the bridge through much of the nineteenth century. A fresh attempt was made in the 1860s, however, and the curving rather than pointed arches of the new bridge suggest employment of an architect or engineer with professional training from elsewhere. In the early 1890s the structure

was extended to become a bridge or viaduct supported on 29 arches, with long ramps up from plain or river level at either end and with a total length given as 348 m. On this occasion there is a positive record of outside experts being employed, a development which reflects changes throughout the Ottoman empire in the later nineteenth century.

4. HERITAGE AND IDENTITY AT MOSUL (*NM, JER*)

Today the architectural heritage of Mosul is generally perceived as comprising the foundation walls of prehistoric Arpachiyah, the palaces, gates and fortifications of Assyrian Nineveh, and the many medieval and modern mosques, churches and other public and private buildings of the old city and its surroundings. Mosul's most vital characteristic, however, binding together all the elements of its rich and diverse heritage, has been continuity of occupation. This is a city whose centre of gravity has repeatedly moved from one bank of the Tigris to the other. Once it looked north and south from the east bank to the fertile Assyrian triangle. In medieval and Ottoman times it looked west towards Diyarbekir and Aleppo. Currently it gravitates east towards Erbil. Without an appreciation of these relationships, it becomes impossible to imagine and implement a sustainable development plan for this sprawling urban complex.

The two banks of the river, with their baggage of history, were crucially linked by the Ottoman bridge, known in its final stage of evolution as the Old Bridge. Photographs reveal it as a magnificent and ingenious structure which combined flexible wooden pontoons with solid masonry arches, demanding recognition as a handsome monument at the very heart of the city. Repairs and improvements were necessary from time to time, and the design of the ramp connecting its component parts was changed more than once, but the bridge remained in use from the 1890s into the 1930s.

The subsequent demolition of the Old Bridge, eliminating the need for maintenance in a period when the Tigris was still liable to flood every spring, must have resulted in the sale and recycling of valuable building materials. This was consistent with tradition because much of the bridge had originally been built with stones removed from the walls and gates of Nineveh. Those same stones were now removed again to perform a third

useful purpose elsewhere (Sa'id al-Daywachi may have known where they went). Fortunately, however, the arches of the closely associated Ottoman bridge across the lower Khosr remained intact, and with refurbishment they continue to perform a vital role in the life of the city.

The Iraqi-Italian Archaeological Expedition, in recommencing excavations at Nineveh, has as its aim not only the scientific exploration of an ancient site but also its long-term protection. Working in close collaboration with local authorities on plans to enhance and exploit this unique and fragile heritage, we aim to create a framework for the conservation of the entire historical urban landscape. Only if appreciated in its full complexity can this heritage be successfully managed and valorized. Our survey of the Ottoman bridge and the historical analysis which we have presented here are our first modest contributions towards reviving that sense of shared identity essential in a city perilously liable to forget the past.

APPENDICES (*JER*)

A1. Post-Ottoman bridges at Mosul

British forces occupied the city of Mosul on 10 November 1918, but the province was not secure (Pl. XIX.2). As explained by Daywachi (1956: 121-122), an obvious priority was a bridge across the Tigris at Mosul that was fit to take military traffic and was separate from the commercial activity around the existing pontoon bridge. It was convenient that in 1914 the Ottoman governor had begun to drive a straight road, Nineveh Street, through the middle of the old city from south-west to north-east, reaching the river a little upstream of Bab al-Jisr. The British completed this work and created stone jetties and another bridge of seventeen pontoons, arranged in pairs. It was 125 yards [114 m] long and 24 feet [7.3 m] wide and ran from the city across to a point on the east bank upstream of the existing bridge (Pl. XX.1). It was properly provided with railings (Pl. XX.2). The date of its completion is not available but was presumably 1919 or 1920.

This became the New Bridge, al-Jisr al-Jadid (Pls. XXI.1 and XXI.2), while the existing pontoon bridge and viaduct became the Old Bridge, al-Jisr al-Qadim. They are na-

mes by which Daywachi must have known them in his childhood. An important novel feature of the New Bridge was that just upstream of it there was another line of pontoons, again arranged in pairs, with no bridge on top; they are visible on the left of Pls. XIV.2, XX.1 and XXI.2 and as a row of specks in the water in Pl. XXII.1. These pontoons must have acted as a breakwater mitigating the ferocity of the current in spring and may have enabled the New Bridge to remain in position throughout the year. Daywachi's plan on Pl. IX.1 indicates the breakwater (although it should have a curving line as shown in the air photograph, Pl. XIV.2) but labels it as *al-Jisr al-Jadid*; this has been corrected in the English legend of Pl. IX.1. On the east bank the road from the New Bridge ran to meet the existing road at the east end of the arches of the Old Bridge, beside the police post. It then continued across the arches of the lower Khosr bridge towards Nabi Yunus and the east.

The New Bridge was removed in 1932, to make way for the Iron Bridge which was originally named after King Ghazi I. It is described as an "8-span Hopkins steel bridge on steel concrete-filled cylindrical piers" (Intelligence Division 1944: 521; Pl. XXII.2). An air photograph (Pl. XXIII.1), shows an early stage in the construction. It has the date of 10 October 1934 stamped on the back but that can hardly be the date the photograph was taken because another photograph (Pl. XXIII.2), which has the date of 8 May 1933 written in the normal way on its front, seems to show a later stage. An undated photograph (Pl. XXIV.1) shows the Iron Bridge complete, in line with Nineveh Street, but the Old Bridge still in use. Yet another undated photograph (Pl. XXIV.2) shows the Iron Bridge complete; the Old Bridge is still complete but for the ramp at its west end. This last photograph had been published at the latest by 1937, with a caption mentioning the demolition of the Old Bridge (Hay and "HW" 1937: fig. facing p. 74). It may be that the ramp was damaged by the spring floods of 1934 and no longer seemed worth repairing. This would fit the statement by Daywachi (1956: 119) that the Old Bridge was demolished in 1934.

The most important feature of the Iron Bridge was that it could carry heavy traffic without further worry throughout the year, regardless of the spring floods. At some stage a "motor-boat ferry of 6 tons capacity" also became available (Intelligence Division 1944: 521). Further details are provided by Daywachi (1956: 122-123), who ends his paper with a reference to the next bridge to be built, further south outside the old city. It was then due to be completed in 1957. That is the bridge that many modern visitors will remember

crossing on their way from the Mosul Museum to Nabi Yunus and beyond, by which time the Iron Bridge could have been called the Old Bridge while the original Old Bridge had largely disappeared. Naturally, because the existing bridges were badly damaged during the Daesh occupation of Mosul, one of the first things done by the Iraq army in July 2017, after regaining control, was to construct a new pontoon bridge over the Tigris.

A2. The lower bridge over the Khosr near the Old Bridge

Rich and Jones recorded the existence of a bridge across the Khosr near its confluence with the Tigris east of the Old Bridge (see above). Daywachi (1956: 119) does not seem to have known about this early Khosr bridge. Instead, he records that the Khosr had originally joined the Tigris upstream of the Old Bridge, which is indeed one of its courses noted by Rich and Jones, and that in 1908, after it had changed its course to the south, a bridge with nine arches was built across it. There is no reason to question this date, but the situation is more complicated.

The Iraq State Board of Antiquities and Heritage possesses an architect's drawing of a bridge with seven arches headed "Pont Hausar" (Pl. XXV.1). A later Arabic heading calls this the original drawing for the stone bridge for the Khosr river and is signed by one 'Amir Salim Hassani but that can only relate to the drawing's subsequent history. I am grateful to Noorah al-Gailani for the relatively clear image of the drawing presented here but some details are blurred and uncertain. The subtitle of the plan may be "Sur les Cintres et Piles construit par G[?] Eutichidis en ajoutant une ouverture[?] de plus d'après la decision de la Commission du Vilayet". This is poor, Levantine French, perhaps written by Mr Eutyichides himself (the substitute letters i in Eutichidis are phonetic spelling). The drawing includes "Plan de fondation de les piles" but at the same time the overlapping outlines of "Piles construit en 1313" and "Ancienne Entré du Pont". The year AH 1313 was AD 1895-6. It therefore seems likely that the drawing was made in 1908, the year given by Daywachi for the foundation of the bridge, but that this was the enhancement or replacement of another bridge with its "Ancienne Entré[e]" and "Piles construit[es] en 1313" which had been constructed in 1895-6 and was not known to Daywachi.

The existing lower Khosr bridge does essentially correspond to the one in the drawing although its arches seem somewhat lower than expected. The style of the architecture is

much like that of the Old Bridge. There are six piers in the drawing which project slightly from the roadway on top and support seven rounded arches. An anomaly is that, although the bridge in the drawing and in some photographs has seven arches and although Daywachi recorded nine, the number is actually eight. This is a consequence of changes at both ends of the bridge.

A useful air photograph of the Tigris in flood beside the wall of Nineveh is dated 17 February 1919 (Pl. XXVI). The lower Khosr bridge is on the left; only four arches are visible but that is because of the angle. The east end of the Old Bridge is on the right, together with the three lower arches of its sloping ramp, as on Pl. XVI.1. It looks as if in addition, beside the ramp, there is now also a causeway which is intended to provide a continuous roadway linking the west end of the Khosr bridge and the east end of the Old Bridge. The two are separated, however, by a short stretch of water. A dark line over the water suggests an improvised wood or iron footbridge. Either the roadway link was unfinished, or it had been swept away. The police post is attached to the south side of the causeway.

The result as it was intended to be, with the roadway in good condition, is visible in the later air photograph (Pl. XIV.2), though that includes too the road on a causeway leading to the New Bridge. The position of the police post is shown more clearly in Pls. XXIII.1 and XXIII.2 which date from the 1930s. By then the position of the ramp had been shifted, from north to south of the police post. This must be because the causeway leading to the New Bridge had blocked access from the north.

The situation is clarified by a detail in the air photographs (Pls. XXIII.1 and XXIV.1), and by later photographs taken at ground level (Pls. XXV.2, XXVII.1 and XXVII.2). These images include a narrower stone arch at the west end of the Khosr bridge (it is not visible on Pl. XXIII.2 because it is hidden behind the police post). This must have been a British addition of 1920 or later. It replaced the improvised footbridge visible beside the police post in Pl. XXVI and ensured a permanent link between the east end of the Old Bridge and the west end of the Khosr bridge itself.

The air photographs also show that by 1933 the easternmost arch of the Khosr bridge had been largely covered with earth. The bridge had become effectively seven-arched. Yet the easternmost arch still existed. It reemerges in later photographs and remains in

use in today's eight-arched bridge (Pls. XXVIII.1 and XXVIII.2). Clearly the people responsible for constructing the original bridge, and for repairing it after flood damage or after slight shifts in the main course of the Khosr, improvised as convenient. It seems improbable on this evidence that the bridge ever had nine arches as stated by Daywachi but perhaps he was including a buried arch near the police post.

A photograph published by Daywachi (Pl. XXV.2) indicates the relationship between the Old Bridge and this Khosr bridge at ground level. The police post complete with flagpole was still standing until recently (Pl. XXVII.1), but must have been destroyed during the Daesh war (Pl. XXVII.2). Changes in stone colour (Pls. XXVII.2, XXVIII.1 and XXVIII.2) show that the four western arches of the bridge were also destroyed but have since been rebuilt. The final stages of reconstruction, exemplifying the integration of modern and traditional techniques, are illustrated by Pls. XXIX.1 and XXIX.2. The lower Khosr bridge is now once again a fine heritage monument still fulfilling its original purpose.

A3. The upper bridge over the Khosr near Kuyunjik

Just south-west of the south-west corner of the mound of Kuyunjik, the Khosr river flows from east to west and is crossed by an important track running from south to north. Near this point it was once possible to cross the Khosr on what in 1904 were called "stepping stones" (Campbell Thompson 1915: 62). These were perhaps part of the substructure of the Assyrian wall of Nineveh, the truncated remains of corbelled arches through which the Khosr flowed out of the ancient city. If so, however, there is no trace of them in a vertical air photograph of January 1919 (Pl. XXX.1).

A masonry bridge of six arches, wide enough for one car, was built here in 1912 (Daywachi 1956: 119; Pl. XXX.2). Photographs show the arches from the south-west (Pls. XXXI.1 and XXXI.2). Their style is clearly close to that of the Old Bridge and the lower Khosr bridge. The material is stone, presumably taken from the Assyrian wall nearby. This upper Khosr bridge was eventually replaced by a concrete bridge. Daywachi dates the change to 1955.

A4. The kelek rafts of Mosul and the middle Tigris

Another type of watercraft found at Ottoman Mosul, alongside the pontoons and fer-

ry-boats, was the kelek, a raft supported by inflated skins. This type of vessel, like the quffa or coracle better known in southern Iraq, could have been prehistoric in origin, employed continuously through thousands of years for the long-distance transmission of people and goods from Anatolia into Mesopotamia. The Akkadian term for these rafts was kalakku. The Assyrian army sometimes used them on campaign (Lanfranchi and Parpola 1990: 145), while an example of civilian use is illustrated in Pl. X.2; here the two central passengers are seated on either side of a cauldron, which suggests that they are on a long trip rather than being merely ferried across the river.

Evidence for long-distance transport down the Tigris in later periods includes an account of the looting of Amida (modern Diyarbakir) by the Sasanians about AD 502-503. They loaded rafts with treasures including “all the statues of the city, and the clock-towers and the marble”. The rafts are described as wooden but it would not be surprising if they were really keleks (Pseudo-Zacharias, quoted from Simpson 2021: 95).

Many European travellers who travelled on kelek rafts in the late Ottoman period, relying on informants as well as on personal observation, took a keen interest in their design and have preserved miscellaneous statistics on things like numbers of rafts and numbers of skins, size, tonnage, cost and length of journey at different seasons of the year. These factors were variable, interdependent and difficult to put together systematically. Some sources seem more reliable than others. More comprehensive information could be recovered, but the following details give a general impression.

One of the more succinct descriptions of a raft is that given by Rich (1836: II, 128). “A kellek is a raft nearly twice as long as it is broad. It is composed of goat-skins blown up, and fastened close together by reeds; this is strengthened by cross pieces of wood, and over these again are laid others to keep the bales of merchandise out of the water. The only fastenings of this machine are twigs. The skins are repaired and blown up afresh every evening, and during the day care is taken to keep them continually wet, which prevents their bursting. These kelleks are conducted by two long oars, the blades of which are made of pieces of split cane fastened together. The passengers arrange themselves as they can on the bales of goods; and if a person wishes to be very much at his ease, he procures a wooden bedstead covered over with a felt awning, which stands in the middle of the kellek, and serves him for a bed by night and a sitting-room by day”.

Later in the century European travellers acquired additional facilities. In April 1880 a party including Ellis (1881: I, 111-114) had two rafts, one with “a hut for Colonel Miles, another for myself, and one to form the kitchen” and another for the “servants and kawas-ses”. This was then rearranged to accommodate more passengers. “On my raft there were Mrs Russell and her maid, myself and my servant, Colonel Miles’s cook, his butler, two zaptiehs [guards], and two kelekjees [raftsmen], in all 10 people. On the other raft were the secretary of Colonel Miles and his servant, two consular kawasses of Baghdad, the writer to Fearan Pacha (the head sheikh of the Shammar Arabs, whose territory we were passing through), two natives of Mosul, one with a wife and two children, the wife and child of one of the kelekjees, besides two kelekjees, in all 14 people. The rafts were large, covering a space 12 to 14 feet square [3.7-4.3 m], and consisted of 250 and 280 skins respectively. They were luxuriously got up with boarding all over, pots of flowers, and an awning over all. On leaving Mosul, over the leading craft floated my old Union Jack flag that had seen so many adventures and was destined finally to act as a sack carrying my bread across the desert on my return journey” (Pl. XXXII.2).

Fraser (1909: 187) had greater privacy. “When a globe-trotter ships aboard a kelek some of the cargo is left behind, and upon the space thus left vacant a hut is erected. A light wooden framework is hung round with cotton walls that roll up or let down according to the desire of the occupant. In addition, the roof has a thick grass mat to keep out the sun. The traveller enjoys entire privacy as regards the people on his own kelek, for he gives orders that nobody is to come abaft his gable. At the end of his little house, and projecting astern of the raft, is a tiny bathroom protected from public gaze by cloth walls. The kitchen is forward of the gable and out of sight. Thus, the kelek combines all the advantages of a modern mansion—living-room, kitchen, sanitary arrangements, abundant light and air, and panoramic scenery that is an eternal feast for the eye”.

Further excellent accounts of how to build and operate traditional rafts were provided by Layard (1849: II, 96-98) and Place (1878: II, 134-140), who both designed special versions to carry their colossal Assyrian human-headed winged stone figures. They also described how to prepare and preserve the leather of the skins, using materials like gal-nuts and pounded pomegranate peel. A neat technical detail was recorded by Ellis (1881: 77): after a skin has been inflated, it is “then carefully examined all over, and if any weak

place appears it is pressed hard with the finger. In three cases out of four the finger goes through and the bag collapses. It is then turned inside out through the neck, and the place mended by pinching it up and tying it round, with half a date stone in the middle to enable the string to bite. When the hole is very large a piece of wood is put in with a notch all round, into which the edge of the skin is tied tight”.

Some rafts were very small. Ussher (1865: 433-434), while floating from Mosul towards Tekrit, overtook “a white-bearded old gentleman” who was “seated astride upon a heap of rushes secured upon half a dozen inflated sheep skins, and thus, tranquilly smoking a pipe, was proceeding, without any exertion on his own part, to his destination. His naked legs hung down on each side into the water, serving as paddles, three or four vigorous kicks sufficing to give his conveyance an inclination either to the right or the left. We offered him a place on our kelek, which he accepted, and taking his frail craft in tow, we continued our course”.

According to Budge, who was in Mosul in 1889, the raft “varies in size from 10 feet to 50 feet square [3.0-15.2 m], and the number of goat-skins used for one raft varies from 50 to 1000” (Budge 1920: 86). One of 30 rafts seen by Geary (1878: II, 28) at Altin Koprü was built of 144 skins. He remarks that they could each carry 80 tons (Imperial, of course, i.e. 81,284 kg, not U.S. tons) but that may be a mistake; if the entire shipment really weighed 80 tons and all the rafts were the same size, each of them carried 2,709 kg. According to McCoan (1879: II, 99) a standard raft would carry about 3.5 tons (3,556 kg). Place (1878: II, 138) states that rafts carrying goods from Mosul to Baghdad usually contained about 300 skins, occasionally 500. A pair of colossal bulls he needed to ship weighed over 30,000 kg. For them therefore “he made two 1600-skin rafts, each 15 by 25 m in area, and he made two 800-skin rafts for a pair of genies, reckoned to weigh 13,500 kg each” (Reade 2018: 175), but that was exceptional. The Handbook (Intelligence Division 1916: 168) states that “the load of a kelek varies from 5 to 36 tons (5,080-36,578 kg), according to the number of skins”, but in view of Place’s account the latter figure is too high.

The larger rafts were sometimes employed for military or special purposes: the significance of river transport in the early Ottoman state is discussed by Husain (2022). Their standard function, however, was commercial. They carried goods in bulk, notably grain and wool, together with the stock of itinerant merchants, besides individual travellers.

The main route on which they were used was from Diyarbakir to Baghdad (Pl. XXXIII). About 300 rafts went annually from Diyarbakir past Hasankeyf to Cizre, 600 went on to Mosul, and 200 went on past Tekrit and Samarra to Baghdad (McCoan 1879: II, 99). Rafts were also constructed on the Lesser Zab, well above its confluence with the Tigris. Henry Percy (1901: 265) had one constructed for himself at Altin Kopru in late autumn, although in spring he could have started from Taqtaq further upstream. The rafts seen by Geary at Altin Kopru were to carry grain; it was said to be a 5-day journey to Baghdad.

More rafts were constructed on the Greater Zab. Budge in 1889, having just passed its confluence with the Tigris, “tied up for the night close to a village inhabited by Jabur Arabs. Here we saw large numbers of mud huts and huge mud vessels filled with grain which had come down on rafts from the country through which the Zab flows. These rafts were huge square structures, and the grain was carried on them packed in sacks from four to six layers deep. Sometimes a raft suffered in its journey down the Zab, and parts of the lowermost layer of sacks became submerged and the grain was spoiled. In such cases the raft was unloaded at the village where we tied up, and the sacks of wet grain taken out, and the broken skins replaced by new. Large quantities of grain were exported from this village to Baghdad” (Budge 1920: II, 99-100). Shields (2000: 104) says that some Mosul products also went by raft beyond Baghdad as far as Basra, but that had not happened before 1850 which was when Layard first loaded colossal figures on to rafts at Nimrud. He subsequently sent many antiquities excavated at Nineveh in the same way while Place sent his figures from Khorsabad. They both had to overcome local objections that the trip to Basra was impossible, and it is not clear that they set a successful precedent. The usual harbours for rafts at Mosul were on the west side of the river but Layard and Place naturally used the east side which was accessible from the major Assyrian sites. Layard (1853: 364) remarks how in 1850 cases of Assyrian sculpture “were dragged in carts to the Tigris, unloaded below the piers of the ancient bridge, and there placed on rafts prepared to receive them”. In 1914 the objects from the German excavations at Ashur travelled on 12 rafts from the site to Baghdad, where they were transferred to a barge (Andrae 1977: 279-281). In 1929 the Chicago expedition to Khorsabad opted for a boat during the spring flood rather than a raft to transport the fragments of another large bull (Loud 1936: 44-55).

Because the pontoon bridge at Mosul blocked the river, rafts were obliged to halt and

unload upstream of it. New rafts were constructed for progress downstream. It was a good opportunity for the authorities to raise money. Shields (2000: 98-99) mentions a monopoly on raft-building that once existed, besides taxes on goat-skins. Tekrit was another town where a transit tax was charged.

It was desirable to have guards on board, to prevent robbery by Kurds and Arabs living in the neighborhood of the river (Pl. XXXIV), but the danger for foreigners was diminishing by the late nineteenth century. "Nothing more annoys the Sultan than to have foreigners maltreated in his territories. The injured nation usually makes a terrible fuss, particularly those with effective fleets" (Fraser 1909: 172). This was widely known. Fraser himself had nearly been murdered in an elaborate plot to attract the Sultan's attention to a local problem. Accordingly, the first instruction to Louisa Jebb and Victoria De Bunsen, when their raft was threatened by robbers, was to demonstrate foreign status by donning conspicuous solar topees: "Pashas", said Hassan in a solemn voice, "put on your hats" (Jebb 1908: 157). When the two ladies left their raft at Samarra and strolled into the sacred town, an alert Ottoman officer saved their lives from the mob (De Bunsen 1910: 202).

According to McCoan (1879: II, 99) the journey from Diyarbakir to Mosul took about 5 days in spring and 15-25 days in autumn. Hume-Griffith (1909: 199-203) was told that in suitable conditions a man could travel on skins from Mosul to Baghdad (over 400 km) in as little as twenty-four hours. That may be an exaggeration, but the smaller rafts could be very fast. She states that in spring "it is possible to travel on the river from Mosul to Baghdad in forty-eight hours, while in the late summer or autumn it takes at least ten or twelve days". Niebuhr (1774-8: II, 354, Tab. XLV) gives three or four days for this journey in spring; the maximum length was 14 days, about the same as by road. Layard, again referring to the journey from Mosul to Baghdad, says that in spring "large rafts are generally six or seven days in performing the voyage. In summer, and when the river is low, they are frequently nearly a month in reaching their destination" (Layard 1849: II, 97-98). A traveller from Mosul to Baghdad in July 1908 could either hire a single 100-skin raft for himself, which would arrive in four or five days, or take a place on an 800-skin raft carrying wheat, which would cost half as much but take twice as long (Fraser 1909: 223).

The river had several rapids or cataracts, best negotiated by day. Niebuhr (1774-8:

II, 355) states that there were three or four between Diyarbekir and Mosul. The most serious obstacle was the Awai or Sakhr Nimrud, downstream of Mosul near the ancient city of Nimrud, possibly the remains of an Assyrian weir. There were other rapids by Jebel Hamrin further downstream. Experienced raftsmen knew how to manoeuvre through them. Rafts often stopped by the river-bank for the night. Since the rafts could only float with the current of the river, downstream, they were dismantled on arrival at their destination. The owner of the raft would sell the wooden fittings and load the skins on to a donkey, taking them back overland to prepare for his next employment. Overall, rafts provided a relatively fast and cheap mode of travel.

Rafts also functioned as ferries when boats were not available. They were used by travellers in the eighteenth and early nineteenth centuries at the main crossing point over the Greater Zab between Mosul and Erbil, where one village is indeed called Eski Kelek. By 1871 there was instead a “flat-bottomed and rudely constructed boat” there (Paterson 1895: 105-106) but it was not yet one capable of carrying horses and mules; they still had to swim. Rafts were in use further up the Greater Zab at Gird-i Mamik in the 1860s: “to cross, the raft is dragged more than half a mile above the starting point, and then propelled obliquely over the current by rude cane oars, down to the opposite landing-place” (McCoan 1879: I, 72). Gird-i Mamik too acquired a “ferry” before 1914 but there was a raft further upstream at Rizan according to the Handbook (Intelligence Division 1917: 281, 286).

Among the travellers cited above, Jebb (1908: 141-237) and De Bunsen (1910) have left vivid descriptions of what happened on a long voyage by raft. Travellers who floated all the way from Diyarbakir to Baghdad are Ellis in 1881, Jebb and De Bunsen in 1907, and Fraser in 1908. Walpole in 1850 floated from Diyarbakir to Mosul and then on to Nimrud. Many more floated from Mosul to Baghdad, including de Thévenot in 1664, Rich in 1820, Mitford and Layard in 1840, Ussher about 1860, Smith in 1873 and Budge in 1889. The commercial journeys by kelek raft from Diyarbekir to Mosul eventually ended after the two cities had been separated by the border between Turkey and Iraq. I was once told that the usually indomitable Freya Stark intended to take this route but was forestalled by the 1958 Iraq revolution. John S. Guest, the expert on Yazidi communities, wished to do so about 1990 but the Saddam government in Iraq refused permission. Similar rafts have continued in use on the upper Tigris into the twenty-first century, but today

there are additional obstacles to long-distance travel in the shape of dams across the river at Hasankeyf, Eski Mosul and Samarra.

These European travellers by raft in the Ottoman period provide an exceptional series of diachronic snapshots of the local population, the nature of nearby settlements and the state of the countryside, from the dry-farmed lands of the upper and middle Tigris to the irrigated expanse of the lower Tigris bordering Babylonia. Besides describing the landscape and their experiences, they offer insight not only into social and economic conditions but also into their own attitudes and opinions as well as those of their companions and the people they met. Their published records constitute an amalgam of field survey, ethnoarchaeology, social anthropology and self-examination. The effortless calm of progress by raft, free from the conventional discomfort and stress of an overland journey, rendered them unusually thoughtful and perceptive.

REFERENCES

- Andrae, W.
1977 *Das wiedererstandene Assur* (B. Hrouda, ed.). Second edition. München: Verlag C. H. Beck.
- Anonymous
1909 *From Monte to Mosul*. London: Bickers & Son.
- Badger, G. P.
1852 *The Nestorians and their Rituals*. 2 vols. London: Joseph Masters.
- Bell, G. L.
1911 *Amurath to Amurath*. London: William Heinemann.
- Benjamin, J., McCarthy, J., Wiseman, C., Bevin, S., Kowlessar, J., Astrup, P.M., Naumann, J., and Hacker, J.
2019 Integrating Aerial and Underwater Data for Archaeology: Digital Maritime Landscapes in 3D: J. McCarthy, J. Benjamin, T. Winton and W. van Duivenvoorde (eds.), *3D Recording and Interpretation for Maritime Archaeology* (Coastal Research Library 31). Springer, Cham, pp. 211-231.
- Berggren, Å., Dell'Unto, N., Forte, M., Haddow, S., Hodder, I., Issavi, J., Lercari, N., Mazzucato, C., Mickel, A., and Taylor, J. S.
2015 Revisiting reflexive archaeology at Çatalhöyük: integrating digital and 3D technologies at the trowel's edge: *Antiquity* 89, pp. 433-448.

Bosco, A.

2022 *3D Surveying Methods and Digital Information Management for Archaeological Heritage* (BAR International Series 3091). BAR Publishing: Oxford.

Boyd, M. J., Campbell, R., Doonan, R. C. P., Douglas, C., Gavalas, G., Gkouma, M., Halley, C., Hartzler, B., Herbst, J. A., Indgjerd, H. R., Krijnen, A., Legaki, I., Margaritis, E., Meyer, N., Moutafi, I., Iliou, N. P., Wylie, D. A., and Renfrew, C.

2021 Open Area, Open Data: Advances in Reflexive Archaeological Practice: *Journal of Field Archaeology* 46, 2, pp. 62-80.

Buckingham, J. S.

1827 *Travels in Mesopotamia*. London: Henry Colburn.

Budge, E. A. T. W.

1920 *By Nile and Tigris*. 2 vols. London: John Murray.

Campbell Thompson, R.

1915 *A Pilgrim's Scrip*. London: John Lane the Bodley Head.

Daywachi, S. al-

1956 The bridges of Mosul: *Sumer* 12 (Arabic section), pp. 108-123.

De Bunsen, V.

1910 *The Soul of a Turk*. London: John Lane the Bodley Head - New York: John Lane Company.

De Graeve, M.-C.

1981 *The Ships of the Ancient Near East (c. 2000-500 B.C.)* (Orientalia Lovaniensia Analecta 7). Leuven: Departement Orientalistiek.

Dell'Unto, N., and Landeschi, G.

2022 *Archaeological 3D GIS*, Routledge: Abingdon-New York.

Dell'Unto, N., Landeschi, G., Apel, J. and Poggi, G.

2017 4D Recording at the Trowel's Edge: Using Three-Dimensional Simulation Platforms to Support Field Interpretation: *Journal of Archaeological Science: Reports* 12, pp. 632-645.

Ellis, T. J.

1881 *On a Raft, and through the Desert*. 2 vols. London: Field & Tuer; Hamilton, Adams & Co. - New York: Scribner & Welford.

Fraser, D.

1909 *The Short Cut to India*. Edinburgh/London: William Blackwood & Sons.

Geary, G.

1878 *Through Asiatic Turkey: Narrative of a Journey from Bombay to the Bosphorus*. 2 vols. London: Sampson Low, Marston, Searle & Rivington.

Grant, A.

1841 *The Nestorians or The Lost Tribes*. London: John Murray.

- Grayson, A. K. and Novotny, J.
 2012 *The Royal Inscriptions of Sennacherib, King of Assyria (704-681 BC), Part I* (The Royal Inscriptions of the Neo-Assyrian Period, Vol. 3/1). Winona Lake: Eisenbrauns.
- Hay, S. and "HW"
 1937 *Air over Eden*. London: Hutchinson & Co.
- Heude, W.
 1819 *A Voyage up the Persian Gulf and a Journey Overland from India to England in 1817*. Reprint 1970 (Farnborough: Gregg International). London: Longman, Hurst, Rees, Orme, and Brown.
- Honigmann, E. and Bosworth, C. E.
 1991 Al-Mawṣil. I. History up to 1900. *Encyclopaedia of Islam* VI: 899-901. New Edition. Leiden: E. J. Brill.
- Hume-Griffith, M. E.
 1909 *Behind the Veil in Persia and Turkish Arabia*. London: Seeley & Co.
- Husain, F.
 2021 *Rivers of the Sultan: The Tigris and Euphrates in the Ottoman Empire*. New York: Oxford University Press.
- Intelligence Division
 1916 *A Handbook of Mesopotamia, Volume I. General*. London: Admiralty and War Office.
 1917 *A Handbook of Mesopotamia, Volume III. Central Mesopotamia with Southern Kurdistan and the Syrian Desert*. London: Admiralty and War Office.
 1944 *Iraq and the Persian Gulf* (Geographical Handbook Series B.R. 524). London: Admiralty.
- Ives, E.
 1773 *A Voyage from England to India in the Year MDCCLIV*. London: Edward and Charles Dilly.
- Jebb, L.
 1908 *By Desert Ways to Baghdad*. London: T. Fisher Unwin.
- Jones, J. F.
 1855 Topography of Nineveh illustrative of the maps of the chief cities of Assyria; and of the general geography of the country intermediate between the Tigris and the Upper Zab. [Read 2nd July 1853.]: *Journal of the Royal Asiatic Society* 15, pp. 297-397, accompanied by *Vestiges of Assyria*, Sheets 1-3.
- Kerim, A.
 1924 *Camera Studies in Iraq*. Date ascribed; no title-page. Baghdad: Hasso Bros.
- Kristiansen, K.
 2014 Towards a New Paradigm? The Third Science Revolution and its Possible Consequences in Archaeology: *Current Swedish Archaeology* 22 (1), pp. 11-34.

- Lanfranchi, G.B., and Parpola, S.
1990 *The Correspondence of Sargon II, Part II: Letters from the Northern and Northeastern Provinces* (State Archives of Assyria, 5). Helsinki: Helsinki University Press.
- Layard, A. H.
1849 *Nineveh and its Remains*. 2 vols. London: John Murray.
1853 *Discoveries in the Ruins of Nineveh and Babylon*. London: John Murray.
1903 *Sir A. Henry Layard, G.C.B., D.C.L., Autobiography and Letters*. Edited by the Hon. William N. Bruce. Two vols. London: John Murray.
- Longrigg, S. H.
1925 *Four Centuries of Modern Iraq*. Reprint 1968 (Farnborough: Gregg International). Oxford: Clarendon Press.
- Loud, G.
1936 *Khorsabad, Part I: Excavations in the Palace and at a City Gate* (Oriental Institute Publications, 38). Chicago: The University of Chicago Press.
- Marchetti, N., and Zaina F.
2020 Rediscovering the Heartland of Cities: South Mesopotamian Early States in Their Setting through New Field Research: *Near Eastern Archaeology* 83, pp. 210–221.
- McCoan, J. C.
1879 *Our New Protectorate. Turkey in Asia. Its Geography, Races, Resources, and Government*. 2 vols. London: Chapman & Hall.
- Merlo, S.
2016 *Making Visible: Three dimensional GIS in Archaeological Excavation* (BAR International Series 2801). BAR Publishing, Oxford.
- Mitford, E. L.
1884 *A Land March from England to Ceylon Forty Years ago*. 2 vols. London: W. H. Allen & Co.
- Niebuhr, C.
1774-8 *Reisebeschreibung nach Arabien und andern umliegenden Ländern*, vol. II. Reprint 1968 (Akademische Druck- u. Verlagsanstalt, Graz). Kopenhagen: Nicolaus Möller; also Hamburg: Friedrich Perthes, 1837.
- Opitz, R., and Limp W.F.
2015 Recent Developments in High-Density Survey and Measurement (HDSM) for Archaeology: Implications for Practice and Theory: *Annual Review of Anthropology* 44, pp. 347-364.
- Otter, J.
1748 *Voyage en Turquie et en Perse*. 2 vols. Paris: Frères Guérin.
- Parpola, S.
1983 *Letters from Assyrian scholars to the kings Esarhaddon and Assurbanipal, Part*

- 2: *Commentary and Appendices* (Alte Orient und Altes Testament 5/2). Kevelaer: Verlag Butzon & Bercker. Neukirchen-Vluyn: Neukirchener Verlag.
- 1987 *The Correspondence of Sargon II, Part 1: Letters from Assyria and the West* (State Archives of Assyria, 1). Helsinki: Helsinki University Press.
- 1993 *Letters from Assyrian and Babylonian Scholars* (State Archives of Assyria, 10). Helsinki: Helsinki University Press.
- Parry, O. H.
1895 *Six Months in a Syrian Monastery*. London: Horace Cox.
- Paterson, J. G.
1895 *From Bombay through Babylonia*. Glasgow: David Bryce & Son.
- Percy, H. A. G. (writing as Lord Warkworth and Earl Percy)
1898 *Notes from a Diary in Asiatic Turkey*. London: Edward Arnold.
1901 *Highlands of Asiatic Turkey*. London: Edward Arnold.
- Place, V.
1870 *Ninive et l'Assyrie*, Vol. II. Paris: Ministère de la Maison de l'Empereur et des Beaux-Arts. Imprimerie impériale.
- Powell, M.A.
1987-1990 Masse und Gewichte: Ebeling and Meissner (eds.), *Reallexikon der Assyriologie und Vorderasiatischen Archäologie* 7, De Gruyter, Berlin-New York, pp. 457-530.
- Putzolu, C., Loy, M., Wallrodt, J., Stocker, S., and Davis, J.
in press Towards a workflow for documenting, processing and archiving large excavation contexts on-the-fly. Challenges and lessons learnt at The Palace of Nestor Project, Pylos: *Proceedings of the 2021 CAA Conference "Digital Crossroads", 14-18 June 2021*.
- Ray, J.
1693 *A Collection of Curious Travels and Voyages in Two Tomes*. London: S. Smith and B. Walford.
- Reade, J. E.
2016 The gates of Nineveh. *State Archives of Assyria Bulletin* 22: pp. 39-93.
2018 Assyrian antiquities lost in translation. *Journal of Cuneiform Studies* 70, pp. 167-188.
- Rich, C. J.
1836 *Narrative of a Residence in Koordistan, Edited by his Widow*. 2 Vols. London: James Duncan, Paternoster Row.
- Ross, H. J.
1902 *Letters from the East, 1837-1857, Edited by his Wife, Janet Ross*. London: Dent & Co.

- Roosevelt, C. H., Cobb, P., Moss, E., Olson, B. R., and Ünlüsoy, S.
2015 Excavation is Destruction Digitization: Advances in Archaeological Practice: *Journal of Field Archaeology* 40, 3, pp. 325-346.
- Shields, S. D.
2000 *Mosul before Iraq. Like Bees Making Five-Sided Cells*. Albany: State University of New York Press.
- Simpson, St. J.
2021 A sculpture of 'The Good Shepherd' from Old Basra: *Sumer* 67, pp. 93-97.
- Skarlatos, D., and Savvidou, E.
2015 Coastal survey of archaeological sites using Drones: *Skyllis* 15, pp. 196-204.
- Smith, G.
1875 *Assyrian Discoveries; an Account of Explorations and Discoveries on the site of Nineveh, during 1873 and 1874*. London: Sampson Low, Marston, Low and Searle.
- Sykes, M.
1904 *Dar-ul-Islam: a Record of a Journey through Ten of the Asiatic Provinces of Turkey*. London: Bickers & Son.
- Tavernier, J. B.
1678 *Les six voyages de Jean Baptiste Tavernier, Ecuyer Baron d'Aubonne, en Turquie, en Perse, at aux Indes*. 2 vols. Suivant la Copie , Imprimée à Paris. Amsterdam: Johannes van Someren.
- Thévenot, J. de
1687 *The Travels of Monsieur de Thevenot into the Levant*. London: Faithorne, Adamson, Skegnes and Newborough.
- Ussher, J.
1865 *A Journey from London to Persepolis*. London: Hurst and Blackett.
- van Leusen, M., and Nobles, G.
2018 3D Spatial Analysis the Road Ahead: Matsumoto, M., and Uleberg, E. (eds.), *Oceans of Data. Proceedings of the 44th Annual Conference on Computer Applications and Quantitative Methods in Archaeology CAA2016*, Archaeopress, Oxford, pp. 471-478.
- Walpole, F.
1851 *The Ansayrii and the Assassins*, 3 vols. London: Richard Bentley.
- Wilkinson, M. W., Jones, R. R., Woods, C. E., Gilment, S. R., McCaffrey K. J. W., Kokkallas, S., and Long J. J.
2016 A comparison of terrestrial laser scanning and structure-from motion photogrammetry as methods for digital outcrop acquisition: *Geosphere* 12/6, pp. 1865-1880, doi: 10.1130/GES01342.1.
- Willis, M. D., Koenig, C. W., Black, S. L. and Castañeda, A. M.
2016 Archeological 3D mapping: the structure from motion revolution: *Journal of Texas Archaeology and History* 3, pp. 1-36.



1. Satellite imagery (Digital Globe 2009) with detail of the surveyed area.

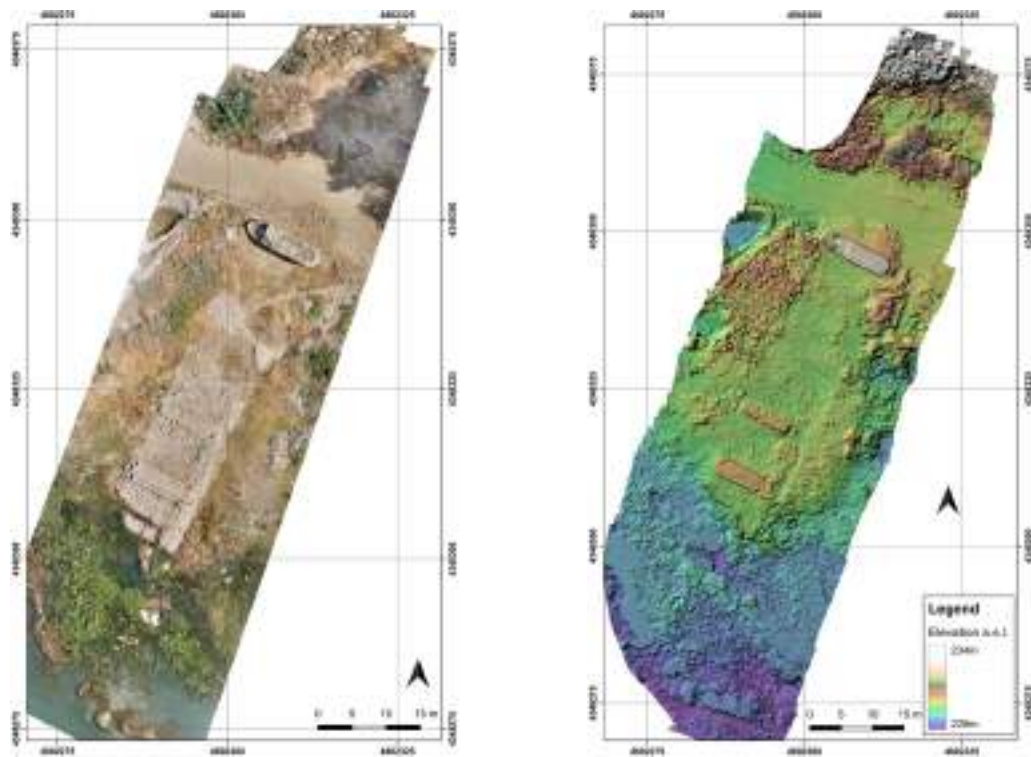

2. Orthophotomodel (left) and DSM (right) of the Old Bridge area.

Pl. II



1. Perspective view from south-west of the Old Bridge DSM.



2. Remains of piers of the Old Bridge. View from south-east.



1. Iron rods anchoring the blocks of the first course to the ground: rusticated ashlar of Pier 1.



2. Iron rod visible inside the hole.



1. Iron clamps interlocked the blocks from the second course upwards. Left: sequence of grooves for the clamps in the upper face of the south-western side of Pier 3; right (above): pair of parallel grooves lodging iron clamps; right (below): iron clamp.



2. Iron plug protruding from a hole in a sixth course ashlar of Pier 3.



1. Close-up of a iron plug and a iron clamp.



2. The only rusticated ashlar used in a curved side of Pier 1.



1. The half-buried remains of Pier 4 from south-west: rusticated ashlars.



2. Pier 4: close-up of an iron clamp and peg.



1. Pier 1 from south-east.



2. Pier 1 from east.



1. Pier 3. Left: view from north-west; right (above): view from west; right (below): view from east.



2. Topographic survey procedures on the area of the Old Bridge.

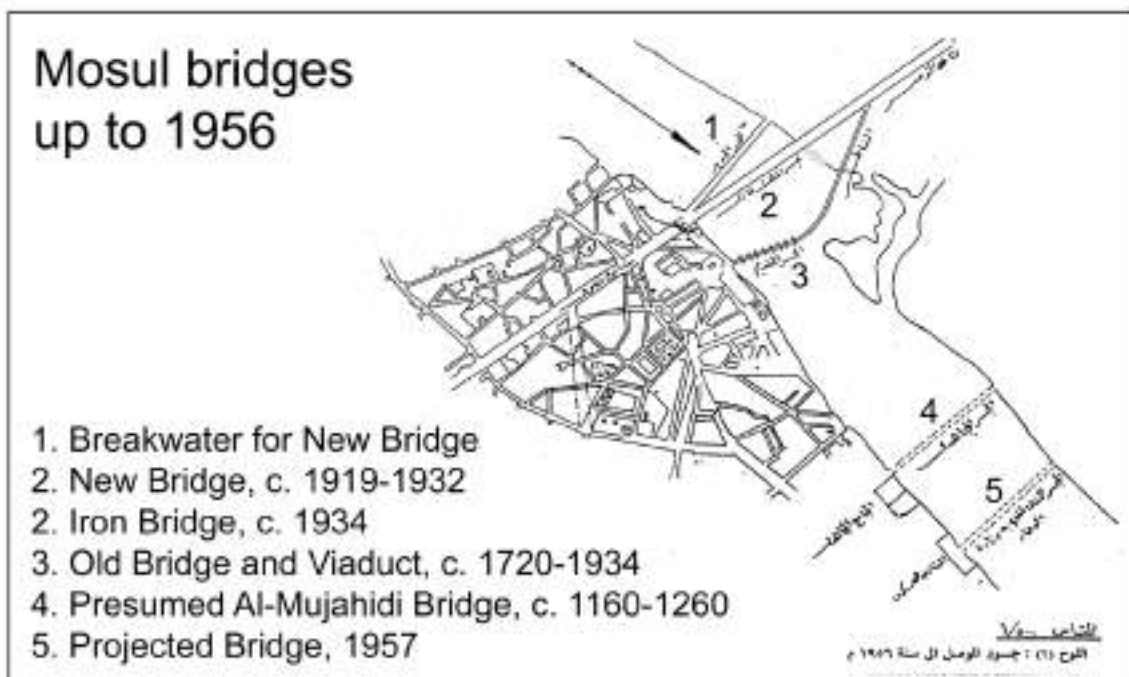

1. Mosul bridges up to 1956. Plan adjusted by J. E. Reade from Daywachi 1956: plan 1.



2. Tigris flood plain at Mosul, 1852. Detail from Jones 1855, sheet 1 (Nineveh).



1. Right bank of Tigris at Mosul. From left to right: projecting stone tower of city-wall surmounted by successive phases, with Imam Yahya and Bash Tabia beyond. View from south-east. Photograph by J. E. Reade. Summer, 1965.

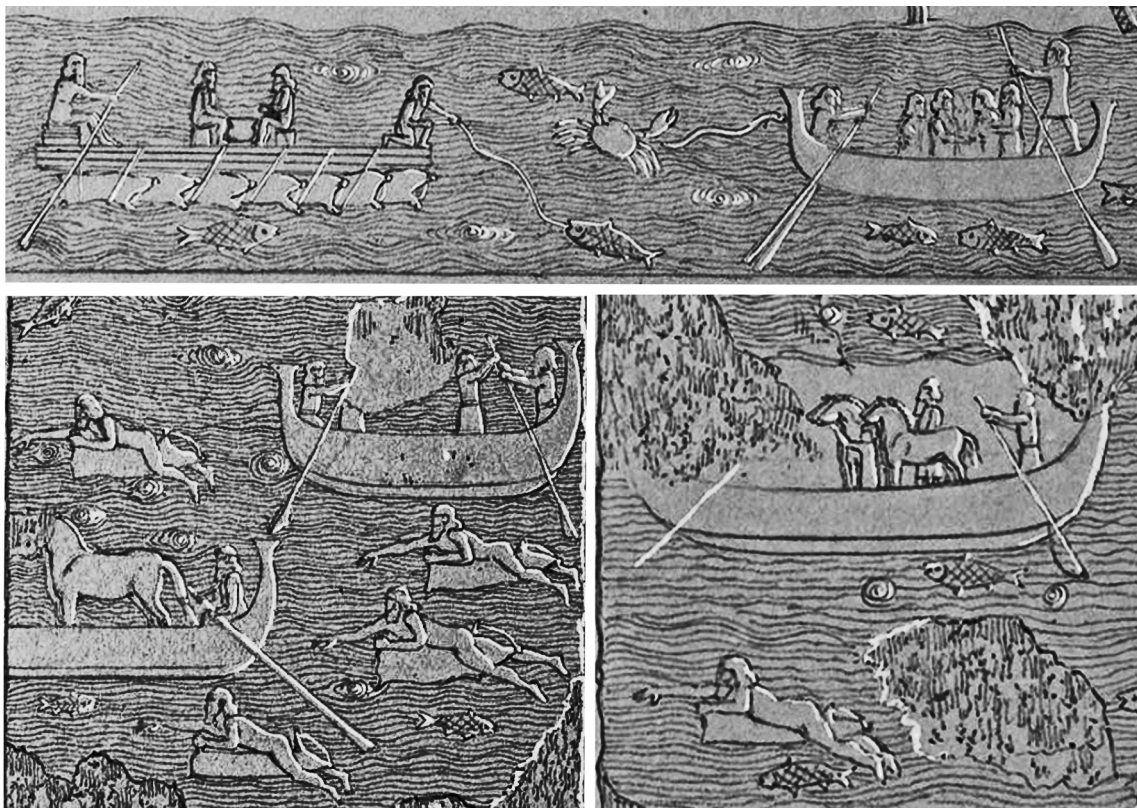

2. Tigris at Nineveh with Assyrians and boats. Not to scale. Compiled by J. E. Reade from drawings by A. H. Layard or F. Cooper, *Original Drawings IV*, 77, 78. Courtesy Trustees of the British Museum.

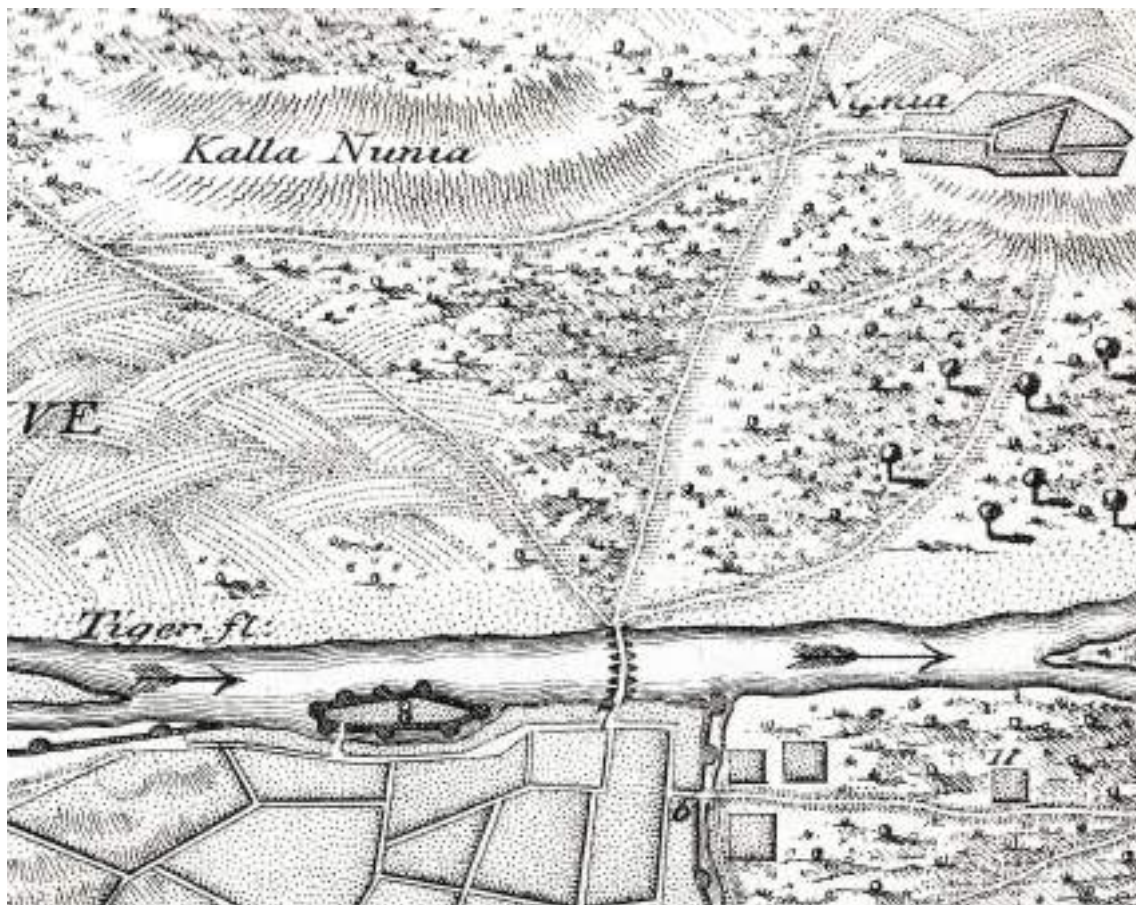

1. Tigris flood plain at Mosul, 1766. Detail from Niebuhr 1774-8: II, pl. XLVI.



2. Workmen removing stone from wall of Nineveh between Kuyunjik and Nabi Yunus, c. 1919. Budge 1920: II, fig. facing p. 6.



1. Tigris flood plain at Mosul, 1820. Detail from Rich 1836: II, plan facing p. 29.



2. Ruined arches leading to pontoon bridge and city of Mosul. View from north-east, 1840s. Badger 1852: fig. facing p. 77.



1. Wall of Mosul on right, rafts in centre, and west end of pontoon bridge on left. View from north-west, 1880. Ellis 1881: 1, fig. facing p. 105.

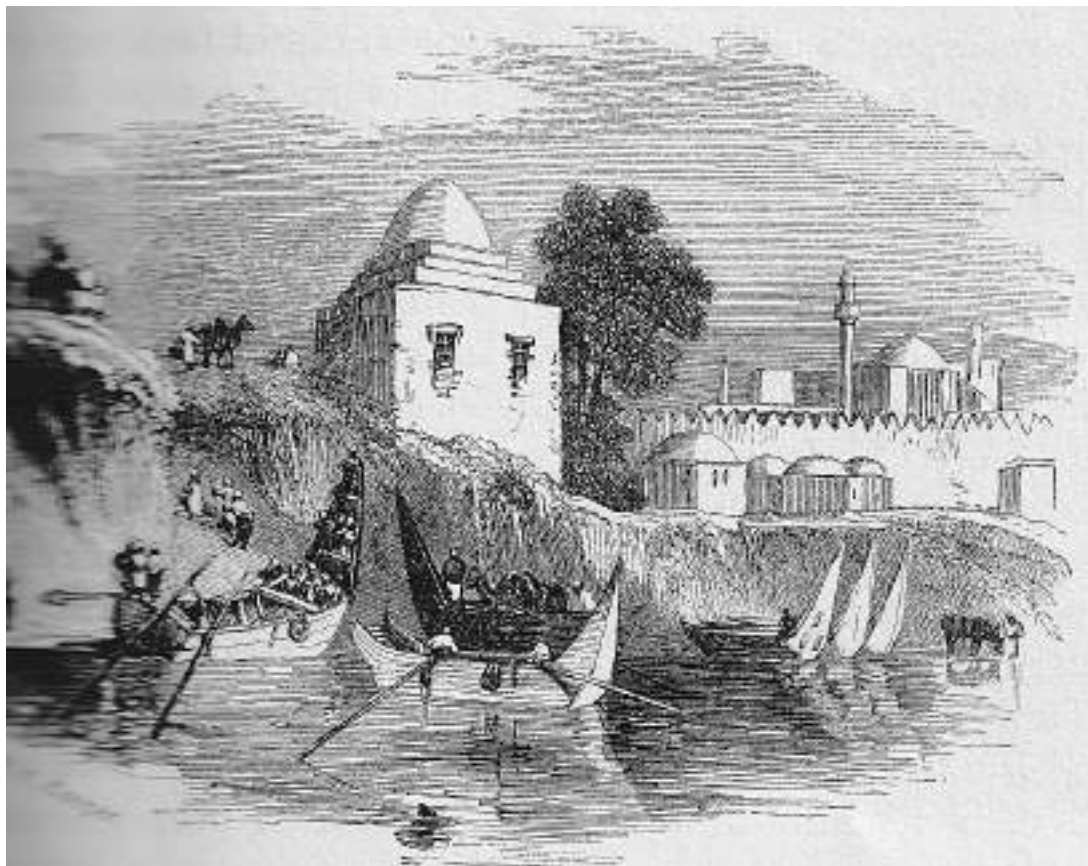

2. Ferry-boats at Mosul. View from east, 1850. Engraved after drawing by S. C. Malan. Layard 1853: 363.



1. Old Bridge with laundry in foreground. View from south-east. Kerim 1924: pl. 49.3.



2. Bridges across Tigris and Khosr. From left to right: breakwater, New Bridge and Old Bridge, with lower Khosr bridge at top. Detail from R.A.F. photograph, A.P.610, c. 1920s. University College London.



1. Iron Bridge during construction, with laundry in foreground. View from south, c. 1933. Donated by V. C. Ditchburn to the EAMENA project, School of Archaeology, University of Oxford.

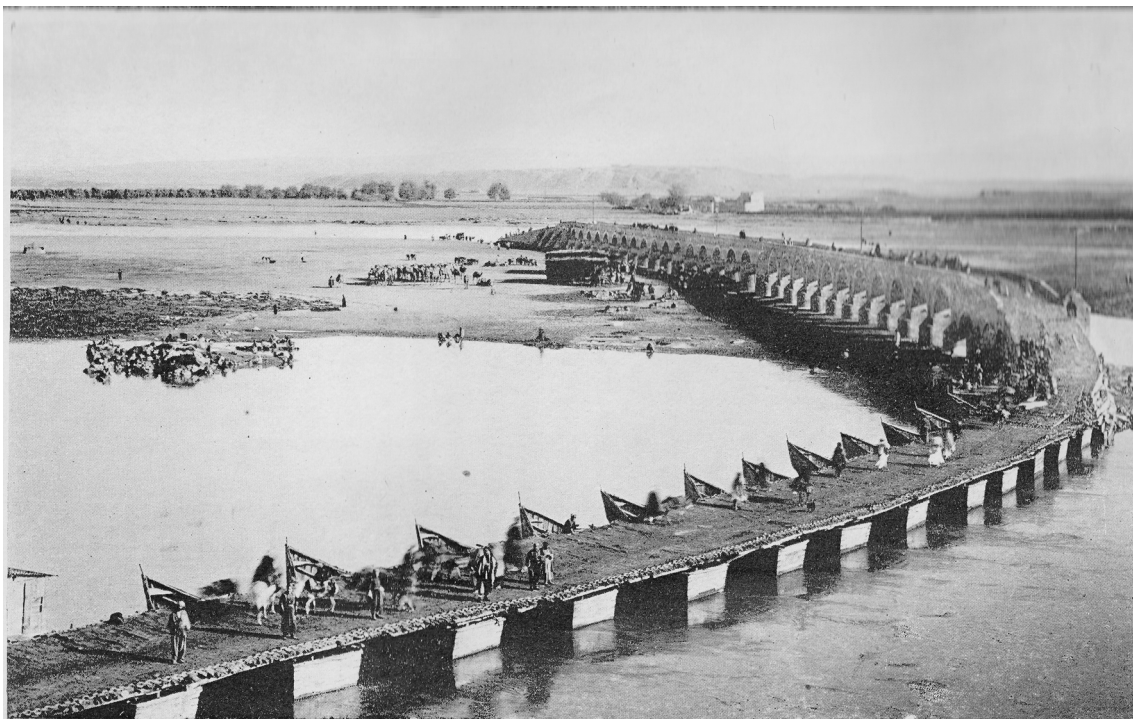

2. Pontoon bridge and Old Bridge. View from south-west, c. 1891-1901. Ross 1902: fig. facing p. 22.



1. Old Bridge, probably before 1908. View from south-east. Postcard, Mission Dominicaine de Mésopotamie.



2. Pontoon bridge and Old Bridge. Above: View from south-west, c. 1920s. Allen album, Middle East Department. Courtesy Trustees of the British Museum; below: View from north-west, 1929. Photograph N. 10373. ISAC Institute for the Study of Ancient Cultures, University of Chicago.



1. Pontoon bridge and Old Bridge. Views from south-west: Pontoons being hauled into position, 1905-1908. Hume-Griffith 1909: fig. facing p. 176



2. Pontoon bridge and Old Bridge. Views from south-west: Pontoons in position, after rebuilding of ramp, c. 1906-1914. Photographer unknown.



1. Old Bridge road with railings, c. 1920s. View from east. Postcard, Mission Dominicaine de Mésopotamie.



2. Old Bridge. View from south-east, after 1891c. 1895=1935. Photographer unknown. Middle East Department. Courtesy Trustees of the British Museum.



1. Old Bridge. View from south, before 1934. Photograph N. 12457. Photograph from James Henry Breasted Collection. ISAC Institute for the Study of Ancient Cultures, University of Chicago.



2. Distant view of Old Bridge before installation of New Bridge. Imam Yahya on left, with British cavalry(?) horses feeding. View from north-west, 1919-1920. Photograph N. 3658, probably taken by James Henry Breasted. ISAC Institute for the Study of Ancient Cultures, University of Chicago.



1. New Bridge with breakwater on left and Old Bridge on right, approached from Nineveh Street. R. A. F. photograph A.P. 475, dated 8 July 1924. University College London.



2. New Bridge road with railings. View from north-east, after 1918. Daywachi 1956: fig. 4B.



1. New Bridge and Old Bridge during high water. View from west, 1919-1924. Kerim 1924: pl. 46.1.

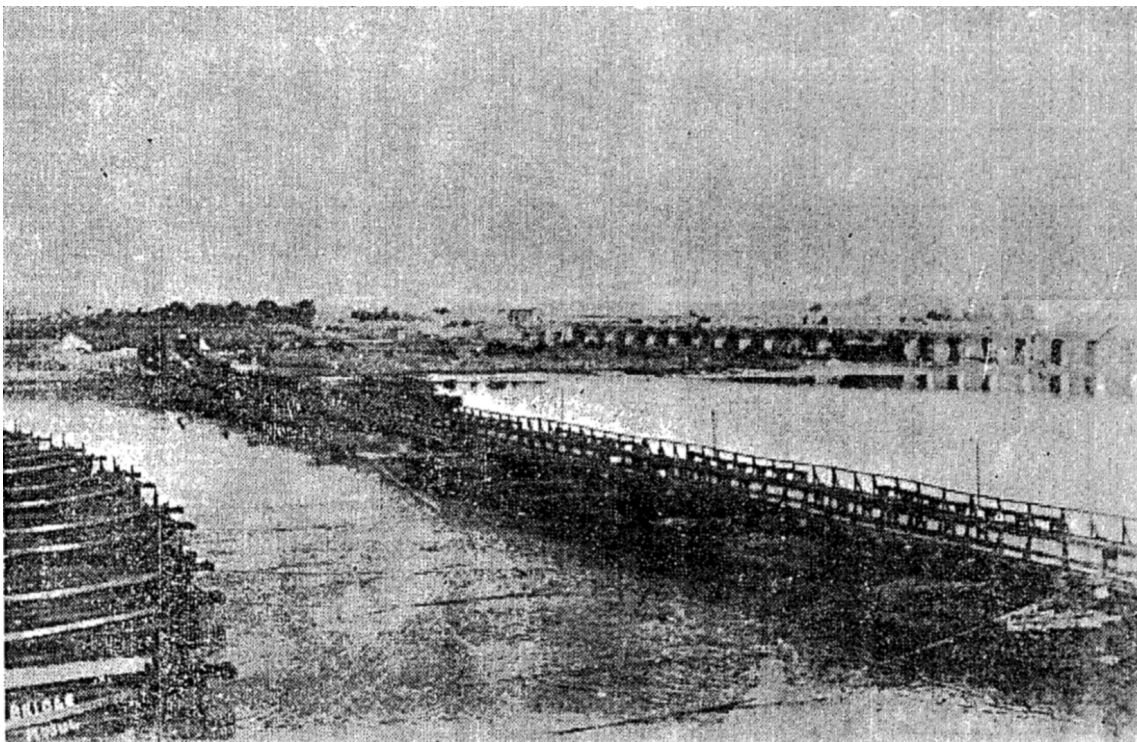

2. New Bridge in centre, with breakwater pontoons on left and Old Bridge on right. View from west, 1919-1932. Daywachi 1956, fig. 5A.



1. Distant view of breakwater pontoons, New Bridge and Old Bridge. View from north-west, 1919-1932. Postcard, Hasso Bros., Baghdad. Courtesy Trustees of the British Museum.

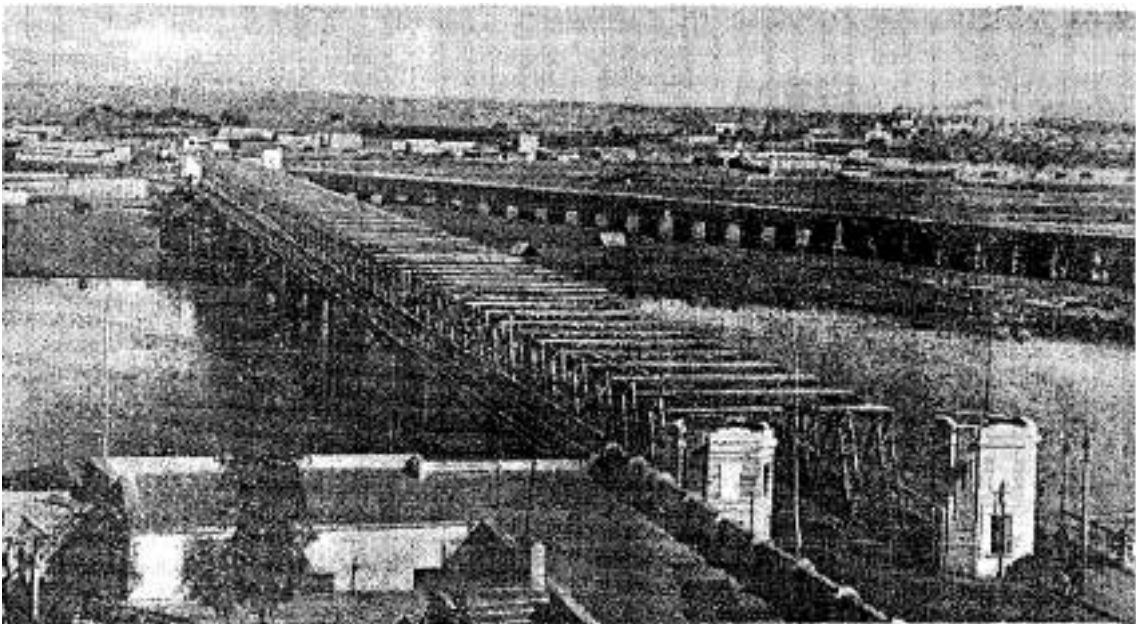

2. Iron Bridge and Old Bridge. View from west, 1933-4. Daywachi 1956: fig. 5B.



1. Mosul, with Old Bridge, Lower Khosr Bridge, and work in progress on Iron Bridge. View from east. R. A. F. photograph, c. 1932-3, stamped 8 October 1934. Courtesy Trustees of the British Museum.



2. Old Bridge, Lower Khosr Bridge, and work in progress on Iron Bridge. View from south. R.A.F. photograph dated 8 May 1933, donated by V. C. Ditchburn to the EAMENA project, School of Archaeology, University of Oxford.



1. Mosul, with Old Bridge, lower Khosr bridge, and Iron Bridge completed. View from east, R.A.F. photograph, 1933-4. Intelligence Division 1944: fig. 200.



2. Mosul, with Royal Air Force planes, Iron Bridge completed, and Old Bridge after loss of west ramp. View from east. R.A.F. photograph, 1934. Donated by V. C. Ditchburn to the EAMENA project, School of Archaeology, University of Oxford.

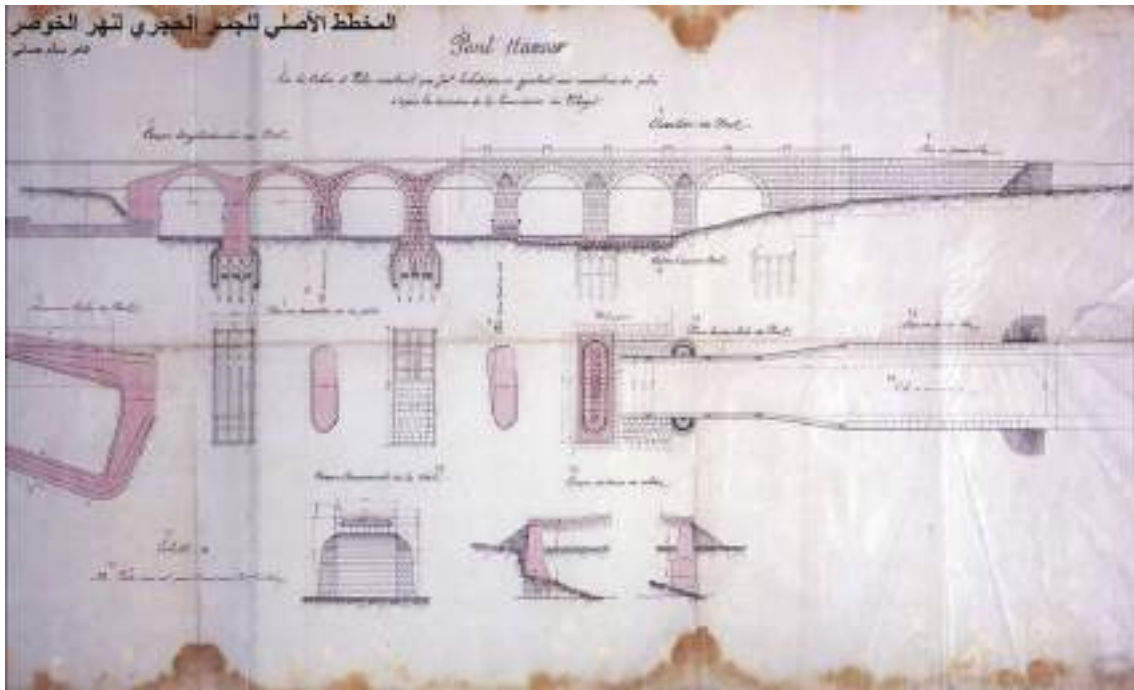

1. Architect's drawing of lower Khosr bridge, c. 1908. Constructed by G[?]. Eutychedes. Mosul Inspectorate of the State Board of Antiquities and Heritage.



2. East end of Old Bridge on left, with police post and west end of lower Khosr bridge on right. View from east, before 1935. Daywachi 1956: fig. 3B.



Above: Tigris flood-plain at Nineveh, with Nabi Yunus at top left, south-west corner of wall of Nineveh at top right, and Old Bridge, police post and lower Khosr bridge in centre. View from north-west. R.A.F. photograph CA 1206, dated 17 February 1919; below: enlargement of central features. Courtesy of the APAAME project (TNA Ref. CN 5/2 Part 4).



1. West end of lower Khosr bridge, with police post. View from east, before 2015. Image by Adnan Adnane 2020, Google Maps.



2. West end of lower Khosr bridge. View from east, after 2016, Google Maps.



1. North side of lower Khosr bridge. View from west, c. 2022, Google Maps.



2. South side of lower Khosr bridge. View from south-west. Photograph January 2023.



1. Centre of lower Khosr bridge under repair. View from south, c. 2019. Image by Aamir Fadel, 2020, Google Maps.



2. East end of lower Khosr bridge under repair. View from south, c. 2019. Image by Adnan Adnane, 2020, Google Maps.



1. Khosr flowing east-west (right to left), with Kuyunjik mound (upper right), upper Khosr bridge (centre left), and Nineveh city-wall (from centre to bottom of photograph). Detail of R.A.F. photograph A.P. 588, dated 6 January 1919. University College London.



2. South-west corner of Kuyunjik, with upper Khosr bridge beyond. View from north-east, c. 1920s. R.A.F. photograph provided by the Mosul Inspectorate of the State Board of Antiquities and Heritage.



1. Upper Khosr bridge, with Kuyunjik mound behind. View from south: Kerim 1924: pl. 44.



2. Upper Khosr bridge, with Kuyunjik mound behind. View from south: Daywachi 1956: fig. 4A.



1. Routes of kelek rafts on Tigris. Map drawn by A. Savioli. Courtesy Land of Nineveh Archaeological Project.



2. Rafts leaving Mosul, 1880. “The old Serai is to the left, and to the right is seen far off the bridge of boats, with some of the dry arches of the stone bridge, behind which is just visible a corner of the mound of Koyunjik”. Ellis 1881: I, fig. facing p. 113.



1. Convoy of rafts on Tigris, Diyarbakir, 1908. Fraser 1909: fig. facing p. 186, edited.



2. Raft ready for departure, Diyarbakir, 1908. Fraser 1909: fig. facing p. 186, edited.



Encounter near Shergat, c. 1860, between kelek raft and Arab party which is crossing the Tigris with plunder. Ussher 1865: fig. facing p. 430.

